

dama
MATERIAIS DE CONSTRUÇÃO

SPAS

MIAMI



SPA MIAMI

RB-SP60 - SPA MIAMI 229x94 / 6 Lug.

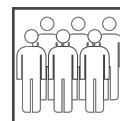

6 390 kg
6,23 m³



3 hidro jatos



2 Bombas de
massagem



Ozono



30 jatos



1 Filtro



Aquecedor de
água



Luz subaquática,
cromoterapia



1 Filtros



Interruptor de
alimentação



Sistema de
controlo Balboa



2 colunas áudio



Radio FM



1,4 m³

3 hidro jatos

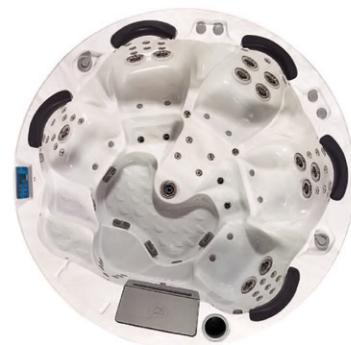

todos os spas são fornecidos sobre encomenda - confirmar prazos de entrega



rubicer

SPA CUBA

410 kg
6,23 m³ **6** 



RB-SP30 - SPA CUBA 231x231x93 / 6 Lug.



3 hidro jatos



2 Bombas de
massagem



O₃ Ozono



30 jatos



1 Filtro



Aquecedor de
água



Luz subaquática,
cromoterapia



1 Filtro



Interruptor de
alimentação



Sistema de
controlo Balboa



1,7 m³

ALVOR



250

SPA ALVOR

RB-SPI0 - SPA ALVOR 228x228x92 / 6 Lug.

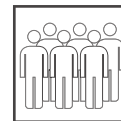

6 410 kg
6,23 m³



11 hidro jatos



Motor 2x 3Cv



Ozono



62 jatos



1 Filtro



Aquecedor de água



Luz subaquática, cromoterapia



1 Filtros



Interruptor de alimentação



Sistema de controlo Balboa



1,63 m³



todos os spas são fornecidos sobre encomenda - confirmar prazos de entrega



rubicer

SPA TOBAGO

330 kg
5,80 m³ **6** 



RB-SP80 - SPA TOBAGO 228x228x94 / 6 Lug.



8 jatos
bifuncionais



Motor 2x3Cv



Ozono



57 jatos



1 Filtro 0,55Cv



Aquecedor de
água



Luz subaquática,
cromoterapia



1 Filtro



Interruptor de
alimentação



Sistema de
controlo Balboa



Radio FM



1,6 m³



Painel de controlo
computorizado



2 colunas áudio

FIJI



SPA FIJI

RB-SP40 - SPA FIJI 203x203x83 / 5 Lug.

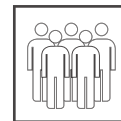

5 297 kg
4,70 m³



9 jatos
bifuncionais



Motor



Ozono



17 jatos



1 Filtro



Aquecedor de
água



Luz subaquática,
cromoterapia



2 Filtros



Interruptor de
alimentação



Sistema de
controlo Balboa



CD Player



1,9 m³



todos os spas são fornecidos sobre encomenda - confirmar prazos de entrega



rubicer

SPA WASAGA

253

300 kg
3,70 m³

4



RB-SP90 - SPA WASAGA 191x191x82 / 4 Lug.



10 jatos
bifuncionais



Motor 2x3Cv



Ozono



37 jatos



1 Filtro 0,55Cv



Aquecedor de
água



Luz subaquática,
cromoterapia



1 Filtro



Interruptor de
alimentação



Sistema de
controlo Balboa



Radio FM



2 colunas áudio



1,9 m³

MONTEREY



254

SPA MONTEREY

RB-SP70 - SPA MONTEREY 205x155x77 / 3 Lug.

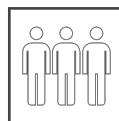

3 231 kg
3 m³



6 jatos
bifuncionais



Motor 2x3Cv



Ozono



45 jatos



1 Filtro 0,75Cv



Aquecedor de
água



Panel de controlo
computorizado



1 Filtro



Interruptor de
alimentação



Luz subaquática,
cromoterapia



2 colunas áudio



Radio FM



Sistema de
controlo Balboa



0,9 m³



todos os spas são fornecidos sobre encomenda - confirmar prazos de entrega



rubicer

SPA MANLY

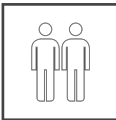
191 kg
2,20 m³ **2** 



RB-SP50 - SPA MANLY 184x124x75 / 2 Lug.



3 jatos
bifuncionais



Motor 1x3Cv



O₃ Ozono



21 jatos



1 Filtro



Aquecedor de
água



Luz subaquática,
cromoterapia



1 Filtro



Interruptor de
alimentação



Sistema de
controlo Balboa



1,1 m³

BORA BORA



RB-SP20 - SPA BORA BORA 587x220x138 / +6 Lug.



14 jatos bifuncionais



Motor 1x1x3Cv



30 jatos



Motor 1x1x2Cv



3 Luz subaquática, cromoterapia



2 Filtros



Sistema de controlo Balboa



2 Filtros



Ozono



Aquecedor de água 3Kw



7,2 m³



Interruptor de alimentação



todos os spas são fornecidos sobre encomenda - confirmar prazos de entrega



RB-CH20
CHUVEIRO EXTERIOR MARGARIDA AO CHÃO
INOX 304
211x8,8 cm / Base 18 CM

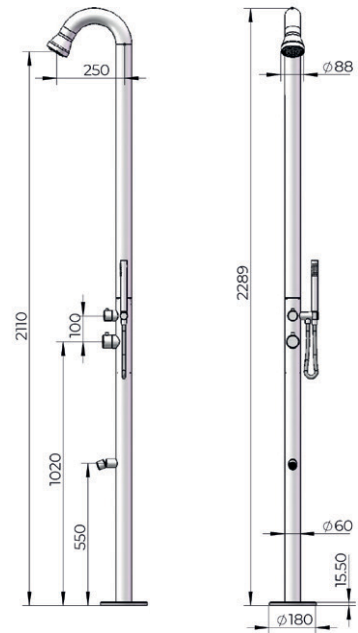

Inox

Margarida

ACESSÓRIOS

COVER MATE



Cobertura para Spas, especialmente concebida para proteger o seu spa. A remoção e reposicionamento é bastante fácil sem risco de abração ou danos no chão ou no equipamento. Desenhado para que possa ser colocado ou removido apenas por uma pessoa. Grande variedade de modelos ajustável também a spas embutidos no chão. Mantem a água quente por mais tempo, permitindo uma poupança de energia substancial.

RB-SP91 - COBERTURA

TV / DVD



RB-SP96 - TV / DVD

ESCADAS

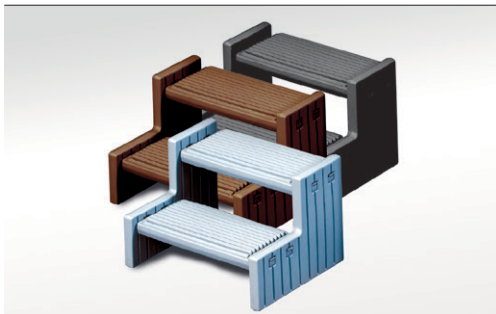

RB-SP92 - ESCADA CASTANHO
RB-SP93 - ESCADA CINZA
RB-SP94 - ESCADA PRETO

CD PLAYER



RB-SP95 - CD PLAYER



BOCA DE ASPIRAÇÃO RAJA63.2



JET DIRECCIONAL RAJA56



JET ROTAOTRIO RAJA55



INVERSOR 2" RAJA 10



JET MINI DUPLA SAIDA



JET FREE RAJA57



POP UP WATERFALL RAJA185



INVERSOR 2" RAJA07



COBERTURA SKIMMER RAJA36



FILTRO SKIMMER RAJA178



CORNER WITH LIGNT RAJA 178



SKIMMER FRONTAL RAJA37



ALMOFADA RAJA02



CORNER LIGNT RAJA 40



PORTA SKIMMER FRONTAL RAJA37



ALMOFADA RAJA04



LONG SIDE-D RAJA21



LP300 MASSAGE PUMP RAJA 123



AIR BLOWER RAJA125



WTC50 CIRCUIT PUMP RAJA 124



CONTROL BALBOA SISTEM RAJA01



PAINEL CONTROL BALBOA RAJAL03



CONTROL BOX BALBOA RAJAL02



D.AMA - Materiais de Construção S.A.

Rua Direita da Toyota S/Nº
 Morro Bento - Samba - Luanda
 Telemovel: 244 926 646 036
 e-mail: geral@damaangola.com

Comercial

Telemovel: 244 934 560 641
 e-mail: comercial@damaangola.com

Showroom

Rua do Imetro S/Nº
 Morro Bento - Samba - Luanda
 Telemovel: 244 940 617 269 / 70
 e-mail: loja@damaangola.com

Showroom Cozinhas

Rua do Imetro S/Nº
 Morro Bento - Samba - Luanda
 Telemovel: 244 940 617 269 / 70
 e-mail: cozinhas@damaangola.com