



dama

CATÁLOGO GERAL

AGOSTO 2024



D.ama – Materiais de Construção S.A., foi constituída em Fevereiro de 2007, é uma empresa de direito Angolano de Capitais nacionais e estrangeiros. Comercializamos produtos das mais conceituadas fábricas Portuguesas e Espanholas, do sector de materiais de construção. A nossa aposta é em produtos de qualidade e design moderno e atual.

Estamos localizados na rua da Direita da Toyota S/No, e ainda na rua do Imetro próximo da Universidade Metropolitana no Morro Bento, dispomos de um amplo Showroom especializado em Materiais de Construção, Sanitários e Electrodomésticos. Lançamos o presente catálogo, onde encontrará uma variada gama de Produtos para acabamento e decoração para a sua casa.

Somos uma empresa especializada na venda de artigos de construção, mosaicos para habitações, artigos de casas de banho e cozinhas equipadas. O nosso conceito de loja é inovador e original, com uma forte aposta na variedade de produtos e soluções para a sua casa.

Garantimos-lhe também os melhores preços do mercado, um atendimento personalizado e um vasto conjunto de serviços para planear, acompanhar e realizar o seu projeto.

INFORMAÇÃO TÉCNICA / SIMBOLOGIA

ESPELHOS



LED



Sensor touch



Desembaciador



Lâmpada



Reversível



Interruptor



Espelho de aumento

LAVA-LOUÇAS

APLICAÇÃO:



À FACE



ENCASTAR A SUPERFICIE



ENCASTRAR



APLICAÇÃO POR BAIXO

ACABAMENTOS:



POLIDO



SATINADO

INCLUI:

Válvula e sifão + todos os acessórios de instalação

1 - MÓVEIS E ESPELHOS

MÓVEIS DE BANHO	4 - 37
MÓVEIS AUXILIARES	38 - 41
ESPELHOS	42 - 52
ACESSÓRIOS	53

2 - LAVATÓRIOS

LAVATÓRIOS DE PÉ / SUSPENDER	56
LAVATÓRIOS DE POUSAR	57 - 68
LAVATÓRIOS DE ENCASTRE	69 - 72
ACESSÓRIOS	73

3 - SANITÁRIOS

SANITÁRIOS	76 - 87
COMPLEMENTOS	88 - 91

4 - MOBILIDADE REDUZIDA

92 - 97

5 - BANHEIRAS E BASES

BANHEIRAS SIMPLES	100 - 102
SISTEMAS DE HISROMASSAGEM	103
PAINÉIS BANHEIRAS	104
BANHEIRAS DE POUSAR	105 - 107
BASES DE CHUVEIRO	108 - 109
BASES DE CHUVEIRO ACRÍLICO	110 - 112
BASES DE CHUVEIRO CERÂMICO / EM PEDRA	112 - 113
CABINES DE HIDROMASSAGEM	113
COMPLEMENTOS PARA BANHEIRAS E BASES	114 - 115
ACESSÓRIOS	116

6 - RESGUARDOS

FRONTAL + LATERAL DE BASE	120 - 121
QUADRADO DE BASE	122 - 123
QUADRADO / RECTANGULAR DE BASE	124
PORTA DE ABRIR	125
PAINÉIS DE BASE FIXOS	126 - 127
CANTO	128 - 130
FRONTAL DE BASE	131
PAINÉIS DE BANHEIRA	132 - 134
FRONTAL + LATERAL BANHEIRA	135 - 137
COMPLEMENTOS PARA RESGUARDOS	137

7 - TORNEIRAS

MONOCOMANDOS DE BANHO	140 - 155
TORNEIRAS TEMPORIZADAS / ELECTRÓNICAS	156 - 157
TORNEIRAS SIMPLY	157
MONOCOMANDOS DE COZINHA	158 - 159
TORNEIRAS DE COZINHA	160 - 161

8 - SISTEMAS DE DUCHE

COLUNAS DE HIDROMASSAGEM	164 - 166
COLUNAS DE DUCHE	167 - 169
RAMPAS DE CHUVEIRO	170
CONJUNTOS DE DUCHE	171
MONOCOMANDOS DE ENCASTRE	172
CHUVEIROS DE ENCASTRE TECTO	173
CHUVEIROS DE PAREDE	173
CHUVEIROS / BRAÇOS DE CHUVEIRO	174
CHUVEIROS DE MÃO	175

9 - ACESSÓRIOS DE BANHO

178 - 189

10 - LAVA - LOUÇAS

192 - 195

11 - ELECTRODOMÉSTICOS

FORNOS 90 CM	198
FORNOS 60 CM	198 - 200
FORNOS GÁS 60 CM	201
GAVETAS DE AQUICIMENTO / MULTIUSOS	201
MÁQUINAS DE CAFÉ	201
MICRO-ONDAS DE ENCASTRE	202
MICRO-ONDAS INSTALAÇÃO LIVRE	203
PLACAS INDUÇÃO	203 - 204
PLACAS INDUGÁS	204
PLACAS VITROCERAMICAS	205
PLACAS A GÁS	205 - 206
PLACAS MODULARES	207
BARBECUES	208
CHAMINÉS DE TECTO	208
CHAMINÉS DE ILHA	208 - 209
CHAMINÉS À PAREDE	209 - 210
EXAUSTOR TELESCÓPICO P/MÓVEL	210
FRIGORIFICOS SIDE BY SIDE	211 - 212
FRIGORIFICOS COMBINADOS	213
ARCAS	214
FRIGORIFICOS / COMBINADOS /ARCAS DE ENCASTRE	214
FRIGORIFICOS / ARCAS DE ENCASTRE BAIXO BANCADA	215
FRIGORIFICOS BAIXO BANCADA LIVRE	215
GARRAFEIRAS	215
MAQUINAS DE LAVAR LOUÇA ENCASTRE	216
MAQUINAS DE LAVAR LOUÇA LIVRES	216
MAQUINAS DE LAVAR ROUPA LIVRES	217
MAQUINAS DE LAVAR ROUPA ENCASTRE	217
MAQUINAS DE LAVAR E SECAR ROUPA	217
MAQUINAS DE SECAR ROUPA	217
TERMOACUMULADORES	218





d!ama

MÓVEIS E ESPELHOS



NOVIDADE



JOTA 80-G3

AML-M105	JOTA MÓVEL 80-G3 BRANCO	880 250,00	1 003 485,00
AML-L195	SUPRA LAVATÓRIO CERÂMICO 80x46	159 250,00	181 545,00
AML-E015	BARI ESPELHO LED BRANCO 60x70	432 250,00	492 765,00
TOTAL CONJUNTO 80 cm		1 471 750,00	1 677 795,00



NOVIDADE

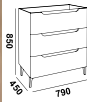

AML-M106	JOTA MÓVEL 80-G3 CARVALHO CLARO	880 250,00	1 003 485,00
AML-L195	SUPRA LAVATÓRIO CERÂMICO 80x46	159 250,00	181 545,00
AML-E015	BARI ESPELHO LED BRANCO 60x70	432 250,00	492 765,00
TOTAL CONJUNTO 80 cm		1 471 750,00	1 677 795,00

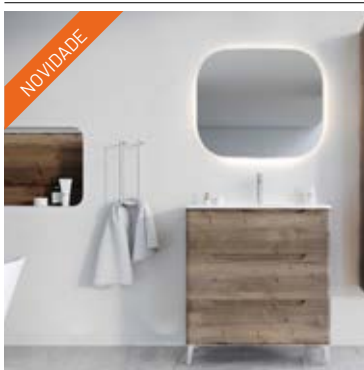

NOVIDADE



AML-M107	JOTA MÓVEL 80-G3 CARVALHO ESCURO	880 250,00	1 003 485,00
AML-L195	SUPRA LAVATÓRIO CERÂMICO 80x46	159 250,00	181 545,00
AML-E015	BARI ESPELHO LED BRANCO 60x70	432 250,00	492 765,00
TOTAL CONJUNTO 80 cm		1 471 750,00	1 677 795,00



NOVIDADE



AML-M108	JOTA MÓVEL 80-G3 CINZA MATE	880 250,00	1 003 485,00
AML-L195	SUPRA LAVATÓRIO CERÂMICO 80x46	159 250,00	181 545,00
AML-E015	BARI ESPELHO LED BRANCO 60x70	432 250,00	492 765,00
TOTAL CONJUNTO 80 cm		1 471 750,00	1 677 795,00

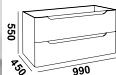
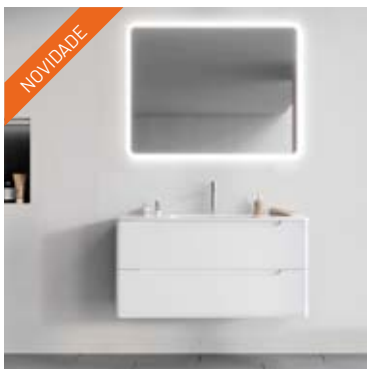

JOTA 100-G2

AML-M101	JOTA MÓVEL 100-G2 BRANCO	688 250,00	784 605,00
AML-L196	SUPRA LAVATÓRIO CERÂMICO 100x46	243 750,00	277 875,00
BM-E062	FRAME ESPELHO LED 100x70	312 250,00	355 965,00
TOTAL CONJUNTO 100 cm		1 244 250,00	1 418 445,00

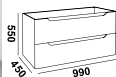
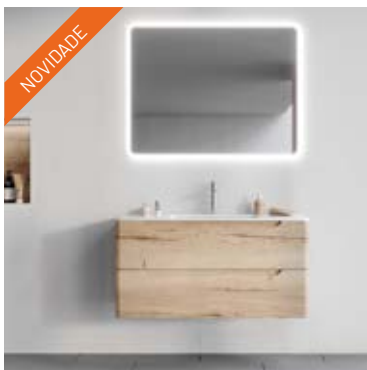

AML-M102	JOTA MÓVEL 100-G2 CARVALHO CLARO	688 250,00	784 605,00
AML-L196	SUPRA LAVATÓRIO CERÂMICO 100x46	243 750,00	277 875,00
BM-E062	FRAME ESPELHO LED 100x70	312 250,00	355 965,00
TOTAL CONJUNTO 100 cm		1 244 250,00	1 418 445,00

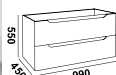
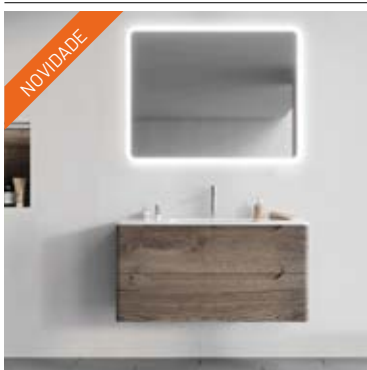

AML-M103	JOTA MÓVEL 100-G2 CARVALHO ESCURO	688 250,00	784 605,00
AML-L196	SUPRA LAVATÓRIO CERÂMICO 100x46	243 750,00	277 875,00
BM-E062	FRAME ESPELHO LED 100x70	312 250,00	355 965,00
TOTAL CONJUNTO 100 cm		1 244 250,00	1 418 445,00

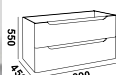
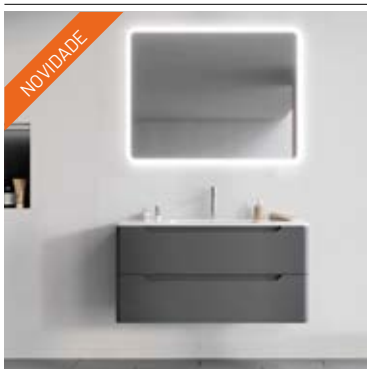

AML-M104	JOTA MÓVEL 100-G2 CINZA MATE	688 250,00	784 605,00
AML-L196	SUPRA LAVATÓRIO CERÂMICO 100x46	243 750,00	277 875,00
BM-E062	FRAME ESPELHO LED 100x70	312 250,00	355 965,00
TOTAL CONJUNTO 100 cm		1 244 250,00	1 418 445,00

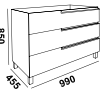

ONE 100-G3

AML-M155	ONE MÓVEL 100-G3 BRANCO	624 250,00	711 645,00
AML-L103	FLATE LAVATÓRIO CERÂMICO 101x46	162 500,00	185 250,00
BM-E062	FRAME ESPELHO LED 100x70	312 250,00	355 965,00
TOTAL CONJUNTO 100 cm		1 099 000,00	1 252 860,00

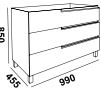

AML-M156	ONE MÓVEL 100-G3 HERCULES	624 250,00	711 645,00
AML-L103	FLATE LAVATÓRIO CERÂMICO 101x46	162 500,00	185 250,00
BM-E062	FRAME ESPELHO LED 100x70	312 250,00	355 965,00
TOTAL CONJUNTO 100 cm		1 099 000,00	1 252 860,00

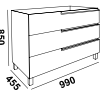

AML-M157	ONE MÓVEL 100-G3 CINZA	624 250,00	711 645,00
AML-L103	FLATE LAVATÓRIO CERÂMICO 101x46	162 500,00	185 250,00
BM-E062	FRAME ESPELHO LED 100x70	312 250,00	355 965,00
TOTAL CONJUNTO 100 cm		1 099 000,00	1 252 860,00

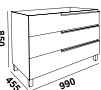

AML-M158/A	ONE MÓVEL 100-G3 BLUE MATE	739 250,00	842 745,00
AML-L103	FLATE LAVATÓRIO CERÂMICO 101x46	162 500,00	185 250,00
BM-E062	FRAME ESPELHO LED 100x70	312 250,00	355 965,00
TOTAL CONJUNTO 100 cm		1 214 000,00	1 383 960,00

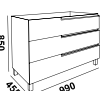
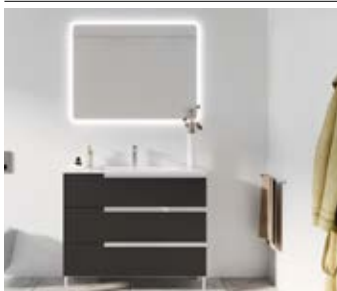

AML-M159	ONE MÓVEL 100-G3 BLACK MATE	739 250,00	842 745,00
AML-L103	FLATE LAVATÓRIO CERÂMICO 101x46	162 500,00	185 250,00
BM-E062	FRAME ESPELHO LED 100x70	312 250,00	355 965,00
TOTAL CONJUNTO 100 cm		1 214 000,00	1 383 960,00

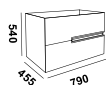

ONE SUSPENSO 80-G2

AML-M150	ONE MÓVEL 80-G2 BRANCO	432 250,00	492 765,00
AML-L102	FLATE LAVATÓRIO CERÂMICO 81x46	108 750,00	123 975,00
AML-E020	BOREAL ESPELHO LED 80x70	336 250,00	383 325,00
TOTAL CONJUNTO 80 cm		877 250,00	1 000 065,00

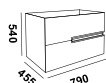

AML-M151	ONE MÓVEL 80-G2 HERCULES	432 250,00	492 765,00
AML-L102	FLATE LAVATÓRIO CERÂMICO 81x46	108 750,00	123 975,00
AML-E020	BOREAL ESPELHO LED 80x70	336 250,00	383 325,00
TOTAL CONJUNTO 80 cm		877 250,00	1 000 065,00

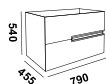

AML-M152	ONE MÓVEL 80-G2 CINZA	432 250,00	492 765,00
AML-L102	FLATE LAVATÓRIO CERÂMICO 81x46	108 750,00	123 975,00
AML-E020	BOREAL ESPELHO LED 80x70	336 250,00	383 325,00
TOTAL CONJUNTO 80 cm		877 250,00	1 000 065,00

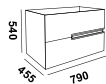

AML-M153	ONE MÓVEL 80-G2 BLUE MATE	504 250,00	574 845,00
AML-L102	FLATE LAVATÓRIO CERÂMICO 81x46	108 750,00	123 975,00
AML-E020	BOREAL ESPELHO LED 80x70	336 250,00	383 325,00
TOTAL CONJUNTO 80 cm		949 250,00	1 082 145,00

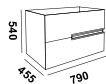

AML-M154	ONE MÓVEL 80-G2 BLACK MATE	504 250,00	574 845,00
AML-L102	FLATE LAVATÓRIO CERÂMICO 81x46	108 750,00	123 975,00
AML-E020	BOREAL ESPELHO LED 80x70	336 250,00	383 325,00
TOTAL CONJUNTO 80 cm		949 250,00	1 082 145,00



PULSE MEL MATE 140

RB-M162/M	PULSE MÓVEL 140 MEL MATE	2 240 250,00	2 553 885,00
RB-M163/M	PULSE MÓVEL AUXILIAR MEL MATE	1 120 250,00	1 277 085,00
RB-L162	PULSE LAVATÓRIO SOLID SURFACE 140 BRANCO MATE	1 040 250,00	1 185 885,00
RB-E160	PULSE ESPELHO LED / 140x60 cm	640 250,00	729 885,00
TOTAL CONJUNTO 140 cm		3 920 750,00	4 469 655,00

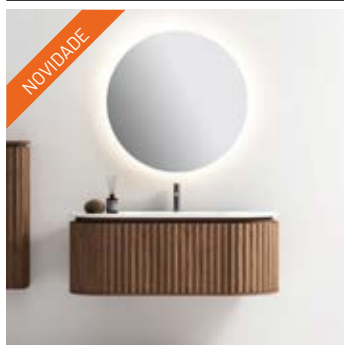

PULSE CASTANHO MATE 120

RB-M161/C	PULSE MÓVEL 120 CARVALHO MATE	2 040 250,00	2 325 885,00
RB-M163/C	PULSE MÓVEL AUXILIAR CARVALHO MATE	1 120 250,00	1 277 085,00
RB-L161	PULSE LAVATÓRIO SOLID SURFACE 120 BRANCO MATE	920 250,00	1 049 085,00
BM-E131	MOON ESPELHO LED 80	304 250,00	346 845,00
TOTAL CONJUNTO 120 cm		3 264 750,00	3 721 815,00



PULSE BRANCO MATE 100

RB-M160/B	PULSE MÓVEL 100 BRANCO MATE	1 600 250,00	1 824 285,00
RB-M163/B	PULSE MÓVEL AUXILIAR BRANCO MATE	1 120 250,00	1 277 085,00
RB-L160	PULSE LAVATÓRIO SOLID SURFACE 100 BRANCO MATE	800 250,00	912 285,00
BM-E131	MOON ESPELHO LED 80	304 250,00	346 845,00
TOTAL CONJUNTO 100 cm		2 704 750,00	3 083 415,00



ORIENT 100 VERDE OLIVA / TEKA

BM-MV152/VT	ORIENT MOVÉL 100 VERDE OLIVA / TEKA	1 216 250,00	1 386 525,00
DAV-L123	LENUS LAVATÓRIO 35 BLACK	178 750,00	203 775,00
BM-E131	MOON ESPELHO LED 80	304 250,00	346 845,00
TOTAL CONJUNTO 100 cm		1 699 250,00	1 937 145,00



ORIENT 120 BRANCO / TEKA

BM-MV153/BT	ORIENT MOVÉL 120 BRANCO / TEKA	1 024 250,00	1 167 645,00
RB-M154/BT	ORIENT MÓVEL AUXILIAR BRANCO / TEKA	560 250,00	638 685,00
DAV-L122-1	LENUS LAVATÓRIO 35 BRANCO MATE	178 750,00	203 775,00
BM-E131	MOON ESPELHO LED 80	304 250,00	346 845,00
TOTAL CONJUNTO 120 cm		1 507 250,00	1 718 265,00

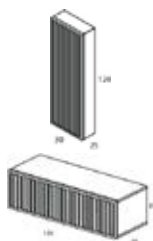

FIRM BRANCO / CARVALHO TABACO 60

BM-MV060	FIRM MOVÉL 60 BRANCO / CARVALHO TABACO LAVATÓRIO MODERN 60 cm	752 250,00	857 565,00
BM-MV063	FIRM AUXILIAR 40 BRANCO / CARVALHO TABACO	752 250,00	857 565,00
AML-E120	LOOK ESPELHO C/ AUMENTO 57x77	120 250,00	137 085,00
TOTAL CONJUNTO 60 cm		872 500,00	994 650,00



FIRM BRANCO / CARVALHO TABACO 80

BM-MV061	FIRM MOVÉL 80 BRANCO / CARVALHO TABACO LAVATÓRIO MODERN 80 cm	880 250,00	1 003 485,00
BM-MV063	FIRM AUXILIAR 40 BRANCO / CARVALHO TABACO	752 250,00	857 565,00
AML-E120	LOOK ESPELHO C/ AUMENTO 57x77	120 250,00	137 085,00
TOTAL CONJUNTO 80 cm		1 000 500,00	1 140 570,00



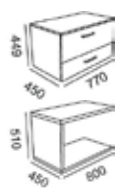

ADAPT COLLECTION 80-225

AML-M010	ADAPT MÓVEL 77 BRANCO	344 250,00	392 445,00
AML-M011	ADAPT MÓVEL U-80 AZABACHE	280 250,00	319 485,00
DAV-L042	DUATI LAVATÓRIO 44	107 250,00	122 265,00
AML-E202	SIDNEY ESPELHO LISO 50x90	68 850,00	78 489,00
TOTAL CONJUNTO 80/150 cm		800 600,00	912 684,00

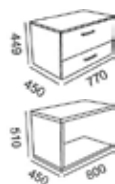

AML-M010	ADAPT MÓVEL 77 BRANCO	344 250,00	392 445,00
AML-M013	ADAPT MÓVEL U-80 BRANCO	280 250,00	319 485,00
AML-L201	SIMPLES LAVATÓRIO CERÂMICO 40 PRETO	237 500,00	270 750,00
AML-E202	SIDNEY ESPELHO LISO 50x90	68 850,00	78 489,00
TOTAL CONJUNTO 80/150 cm		930 850,00	1 061 169,00

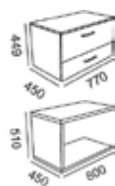

AML-M010	ADAPT MÓVEL 77 BRANCO	344 250,00	392 445,00
AML-M012	ADAPT MÓVEL U-80 ESTEPA x2	560 500,00	638 970,00
RB-L025	BOL LAVATÓRIO CERÂMICO 42 x2	243 750,00	277 875,00
AML-E150	MOON ESPELHO C/ AUMENTO 70 x2	256 500,00	292 410,00
TOTAL CONJUNTO 160/225 cm		1 405 000,00	1 601 700,00



URBAN COLLECTION 60-80

AML-M275	URBAN MÓVEL 60-G1 BRANCO x2	464 500,00	529 530,00
AML-T124-2	PLAY TAMPO 120 CINZA x2	313 700,00	357 618,00
AML-C103	GLAMOUR SUPORTE x2	160 500,00	182 970,00
DAV-L041	DUATI LAVATÓRIO CERÂMICO 50x42	110 500,00	125 970,00
AML-E206	SIDNEY ESPELHO LISO 120	128 250,00	146 205,00
TOTAL CONJUNTO 120 cm		1177 450,00	1342 293,00



AML-M276	URBAN MÓVEL 80-G1 BRANCO	256 250,00	292 125,00
AML-T084-2	PLAY TAMPO 80 CINZA x2	224 500,00	255 930,00
AML-C103	GLAMOUR SUPORTE x2	160 500,00	182 970,00
DAV-L041	DUATI LAVATÓRIO CERÂMICO 50x42	110 500,00	125 970,00
AML-E201	SIDNEY ESPELHO LISO 57x77	59 250,00	67 545,00
TOTAL CONJUNTO 80 cm		811 000,00	924 540,00

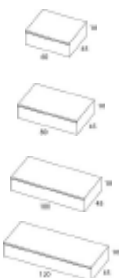
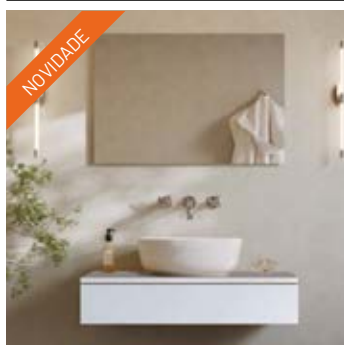

PAX MÓVEL 60-80-100-120

BM-MV160	PAX MÓVEL 60-G1 BRANCO	368 250,00	419 805,00
BM-MV161	PAX MÓVEL 80-G1 BRANCO	400 250,00	456 285,00
BM-MV162	PAX MÓVEL 100-G1 BRANCO	448 250,00	511 005,00
BM-MV163	PAX MÓVEL 120-G1 BRANCO	560 250,00	638 685,00



DECORUM 80

IT-M040	MÓVEL DECORUM WHITE 80 Direito	531 500,00	605 910,00
IT-M041	MÓVEL DECORUM WHITE 80 Esquerdo	531 500,00	605 910,00
IT-M042	MÓVEL DECORUM WHITE & BLACK 80 Direito	531 500,00	605 910,00
IT-M043	MÓVEL DECORUM WHITE & BLACK 80 Esquerdo	531 500,00	605 910,00

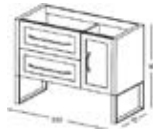

CLASSIC 100 WHITE MATE / OURO

BM-MV032	CLASSIC MÓVEL BRANCO MATE 100 ACABAMENTO OURO	1 664 250,00	1 897 245,00
BM-L182	RIME LAVATÓRIO SOLID SURFACE 100	768 250,00	875 805,00
BM-E062	FRAME ESPELHO LED 100x70	312 250,00	355 965,00
TOTAL CONJUNTO 100 cm		2 744 750,00	3 129 015,00



VINCE / VINCE SUSPENSO 100

AML-M290	VINCE MÓVEL 100 BRANCO / HERCULES	584 250,00	666 045,00
AML-L103	FLATE LAVATÓRIO CERÂMICO 101x46	162 500,00	185 250,00
BM-E131	MOON ESPELHO LED 80	304 250,00	346 845,00
TOTAL CONJUNTO 100 cm		1 051 000,00	1 198 140,00

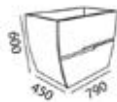

SOUL WHITE 80

AML-M221	SOUL MÓVEL 80 BRANCO	960 250,00	1 094 685,00
AML-L102/P	FLATE LAVATÓRIO CERÂMICO 81x46 PRETO	162 500,00	185 250,00
AML-E150	MOON ESPELHO C/ AUMENTO 70	128 250,00	146 205,00
TOTAL CONJUNTO 80 cm		1 251 000,00	1 426 140,00



PURE WHITE 80

AML-M165	PURE MÓVEL 80 BRANCO	736 250,00	839 325,00
AML-L102	FLATE LAVATÓRIO CERÂMICO 81x46	108 750,00	123 975,00
AML-E201	SIDNEY ESPELHO LISO 57x77	59 250,00	67 545,00
TOTAL CONJUNTO 80 cm		904 250,00	1030 845,00

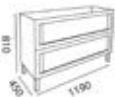

PRISMA BRANCO ROBLE 120

AML-M201	PRISMA MÓVEL 120 BRANCO / ROBLE	682 250,00	777 765,00
AML-L104	FLATE LAVATÓRIO CERÂMICO 121x46	230 750,00	263 055,00
AML-E021	BOREAL ESPELHO LED 120x70	368 250,00	419 805,00
TOTAL CONJUNTO 120 cm		1 281 250,00	1 460 625,00



LIGHT 80 / 120

IT-M122	LIGHT MÓVEL 80 + TAMPO CORIAN BRANCO	562 750,00	641 535,00
IT-M120	LIGHT MÓVEL 120 + TAMPO CORIAN BRANCO	742 750,00	846 735,00
AML-L201	SIMPLE LAVATÓRIO CERÂMICO PRETO	237 500,00	270 750,00
IT-E210	UNIQUE ESPELHO 80x80 PRETO	262 525,00	299 278,50
TOTAL CONJUNTO 80 cm		1 062 775,00	1 211 563,50



PLAY V2 60-G2

AML-M186-V	PLAY V2 SUSPENSO 60-G2 BRANCO	248 250,00	283 005,00
AML-L101	FLATE LAVATÓRIO CERÂMICO 61x46	97 500,00	111 150,00
AML-E201	SIDNEY ESPELHO LISO 57x77	59 250,00	67 545,00
TOTAL CONJUNTO 60 cm		405 000,00	461 700,00



AML-M185-V	PLAY V2 SUSPENSO 60-G2 AZABACHE	248 250,00	283 005,00
AML-L101	FLATE LAVATÓRIO CERÂMICO 61x46	97 500,00	111 150,00
AML-E201	SIDNEY ESPELHO LISO 57x77	59 250,00	67 545,00
TOTAL CONJUNTO 60 cm		405 000,00	461 700,00



AML-M189-IV	PLAY V2 SUSPENSO 60-G2 HERCULES	248 250,00	283 005,00
AML-L101	FLATE LAVATÓRIO CERÂMICO 61x46	97 500,00	111 150,00
AML-E201	SIDNEY ESPELHO LISO 57x77	59 250,00	67 545,00
TOTAL CONJUNTO 60 cm		405 000,00	461 700,00



AML-M189-2V	PLAY V2 SUSPENSO 60-G2 CINZA	248 250,00	283 005,00
AML-L101	FLATE LAVATÓRIO CERÂMICO 61x46	97 500,00	111 150,00
AML-E201	SIDNEY ESPELHO LISO 57x77	59 250,00	67 545,00
TOTAL CONJUNTO 60 cm		405 000,00	461 700,00



AML-M189-3V	PLAY V2 SUSPENSO 60-G2 CARVALHO	248 250,00	283 005,00
AML-L101	FLATE LAVATÓRIO CERÂMICO 61x46	97 500,00	111 150,00
AML-E201	SIDNEY ESPELHO LISO 57x77	59 250,00	67 545,00
TOTAL CONJUNTO 60 cm		405 000,00	461 700,00

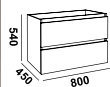

PLAY V2 80-G2

AML-M191-V	PLAY V2 SUSPENSO 80-G2 BRANCO	280 250,00	319 485,00
AML-L102	FLATE LAVATÓRIO CERÂMICO 81x46	108 750,00	123 975,00
AML-E203	SIDNEY ESPELHO LISO 70x90	89 750,00	102 315,00
TOTAL CONJUNTO 80 cm		478 750,00	545 775,00

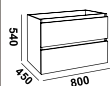
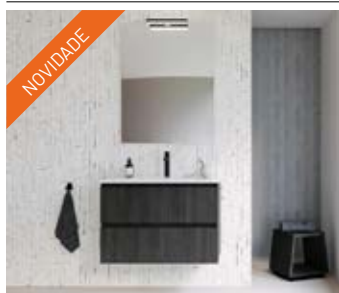

AML-M190-V	PLAY V2 SUSPENSO 80-G2 AZABACHE	280 250,00	319 485,00
AML-L102	FLATE LAVATÓRIO CERÂMICO 81x46	108 750,00	123 975,00
AML-E203	SIDNEY ESPELHO LISO 70x90	89 750,00	102 315,00
TOTAL CONJUNTO 80 cm		478 750,00	545 775,00

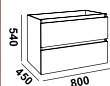

AML-M194-1V	PLAY V2 SUSPENSO 80-G2 HERCULES	280 250,00	319 485,00
AML-L102	FLATE LAVATÓRIO CERÂMICO 81x46	108 750,00	123 975,00
AML-E203	SIDNEY ESPELHO LISO 70x90	89 750,00	102 315,00
TOTAL CONJUNTO 80 cm		478 750,00	545 775,00

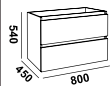

AML-M194-2V	PLAY V2 SUSPENSO 80-G2 CINZA	280 250,00	319 485,00
AML-L102	FLATE LAVATÓRIO CERÂMICO 81x46	108 750,00	123 975,00
AML-E203	SIDNEY ESPELHO LISO 70x90	89 750,00	102 315,00
TOTAL CONJUNTO 80 cm		478 750,00	545 775,00

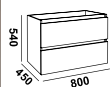

AML-M194-3V	PLAY V2 SUSPENSO 80-G2 CARVALHO	280 250,00	319 485,00
AML-L102	FLATE LAVATÓRIO CERÂMICO 81x46	108 750,00	123 975,00
AML-E203	SIDNEY ESPELHO LISO 70x90	89 750,00	102 315,00
TOTAL CONJUNTO 80 cm		478 750,00	545 775,00

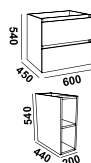

PLAY V2 80-G2 / MODULAR

AML-M186-V	PLAY V2 SUSPENSO 60-G2 BRANCO	248 250,00	283 005,00
AML-M174-3	PLAY V2 SUSPENSO 20-A CARVALHO	70 500,00	80 370,00
AML-L070	ELITE L LAVATÓRIO CERÂMICO ESQUERDO 81x46	203 125,00	231 562,50
AML-E201	SIDNEY ESPELHO LISO 57x77	59 250,00	67 545,00
TOTAL CONJUNTO 80 cm		581 125,00	662 482,50

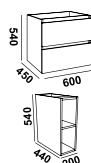
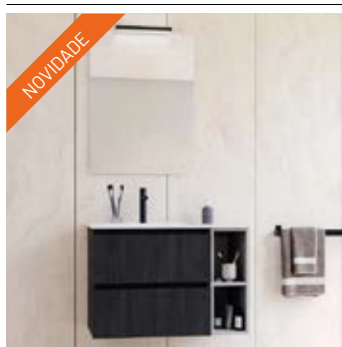

AML-M185-V	PLAY V2 SUSPENSO 60-G2 AZABACHE	248 250,00	283 005,00
AML-M174-2	PLAY V2 SUSPENSO 20-A CINZA	70 500,00	80 370,00
AML-L071	ELITE R LAVATÓRIO CERÂMICO DIREITO 81x46	203 125,00	231 562,50
AML-E201	SIDNEY ESPELHO LISO 57x77	59 250,00	67 545,00
TOTAL CONJUNTO 80 cm		581 125,00	662 482,50

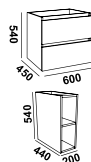

AML-M189-1V	PLAY V2 SUSPENSO 60-G2 HERCULES	248 250,00	283 005,00
AML-M170	PLAY V2 SUSPENSO 20-A AZABACHE	70 500,00	80 370,00
AML-T080	PLAY TAMPO 80 AZABACHE	112 250,00	127 965,00
DAV-L042	DUATI LAVATÓRIO CERÂMICO 44x44	107 250,00	122 265,00
AML-E201	SIDNEY ESPELHO LISO 57x77	59 250,00	67 545,00
TOTAL CONJUNTO 80 cm		597 500,00	681 150,00

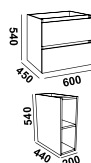

AML-M189-3V	PLAY V2 SUSPENSO 60-G2 CARVALHO	248 250,00	283 005,00
AML-M171	PLAY V2 SUSPENSO 20-A BRANCO	70 500,00	80 370,00
AML-T081	PLAY TAMPO 80 BRANCO	112 250,00	127 965,00
DAV-L042	DUATI LAVATÓRIO CERÂMICO 44x44	107 250,00	122 265,00
AML-E201	SIDNEY ESPELHO LISO 57x77	59 250,00	67 545,00
TOTAL CONJUNTO 80 cm		597 500,00	681 150,00

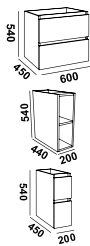

PLAY V2 100-G2 / MODULAR

AML-M189-1V	PLAY V2 SUSPENSO 60-G2 HERCULES	248 250,00	283 005,00
AML-M170	PLAY V2 SUSPENSO 20-A AZABACHE	70 500,00	80 370,00
AML-M179-1V	PLAY V2 SUSPENSO 20-G2 HERCULES	168 250,00	191 805,00
AML-L072	ELITE L LAVATÓRIO CERÂMICO ESQUERDO 101x46	341 250,00	389 025,00
AML-E204	SIDNEY ESPELHO LISO 80x90	96 250,00	109 725,00
TOTAL CONJUNTO 100 cm		924 500,00	1 053 930,00

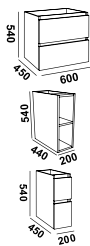

AML-M189-2V	PLAY V2 SUSPENSO 60-G2 CINZA	248 250,00	283 005,00
AML-M170	PLAY V2 SUSPENSO 20-A AZABACHE	70 500,00	80 370,00
AML-M179-2V	PLAY V2 SUSPENSO 20-G2 CINZA	168 250,00	191 805,00
AML-L073	ELITE R LAVATÓRIO CERÂMICO DIREITO 101x46	341 250,00	389 025,00
AML-E204	SIDNEY ESPELHO LISO 80x90	96 250,00	109 725,00
TOTAL CONJUNTO 100 cm		924 500,00	1 053 930,00

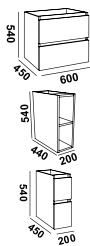
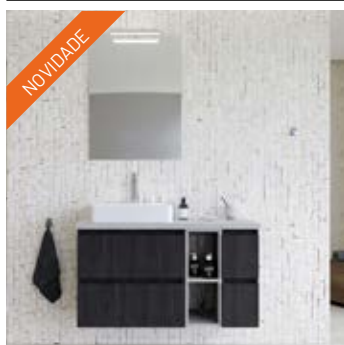

AML-M185-V	PLAY V2 SUSPENSO 60-G2 AZABACHE	248 250,00	283 005,00
AML-M174-2	PLAY V2 SUSPENSO 20-A CINZA	70 500,00	80 370,00
AML-M175-V	PLAY V2 SUSPENSO 20-G2 AZABACHE	168 250,00	191 805,00
AML-T104-2	PLAY TAMPO 100 CINZA	136 250,00	155 325,00
DAV-L042	DUATI LAVATÓRIO CERÂMICO 44x44	107 250,00	122 265,00
AML-E201	SIDNEY ESPELHO LISO 57x77	59 250,00	67 545,00
TOTAL CONJUNTO 100 cm		789 750,00	900 315,00

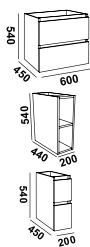

AML-M186-V	PLAY V2 SUSPENSO 60-G2 BRANCO	248 250,00	283 005,00
AML-M174-3	PLAY V2 SUSPENSO 20-A CARVALHO	70 500,00	80 370,00
AML-M176-V	PLAY V2 SUSPENSO 20-G2 BRANCO	168 250,00	191 805,00
AML-T104-3	PLAY TAMPO 100 CARVALHO	136 250,00	155 325,00
DAV-L042	DUATI LAVATÓRIO CERÂMICO 44x44	107 250,00	122 265,00
AML-E201	SIDNEY ESPELHO LISO 57x77	59 250,00	67 545,00
TOTAL CONJUNTO 100 cm		789 750,00	900 315,00

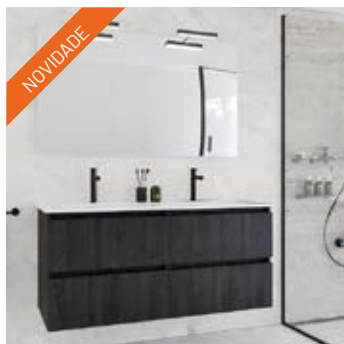

PLAY V2 120-G2 / MODULAR



AML-M185-V	PLAY V2 SUSPENSO 60-G2 AZABACHE X2	496 500,00	566 010,00
AML-L105	FLATE LAVATÓRIO CERÂMICO DUPL0 121x46	242 250,00	276 165,00
AML-E206	SIDNEY ESPELHO LISO 120x70	128 250,00	146 205,00
TOTAL CONJUNTO 120 cm		867 000,00	988 380,00



AML-M186-V	PLAY V2 SUSPENSO 60-G2 BRANCO X2	496 500,00	566 010,00
AML-T120	PLAY TAMPO 120 AZABACHE	156 850,00	178 809,00
DAV-L042	DUATI LAVATÓRIO CERÂMICO 44x44 X2	214 500,00	244 530,00
AML-E206	SIDNEY ESPELHO LISO 120x70	128 250,00	146 205,00
TOTAL CONJUNTO 120 cm		996 100,00	1 135 554,00

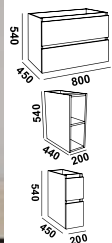
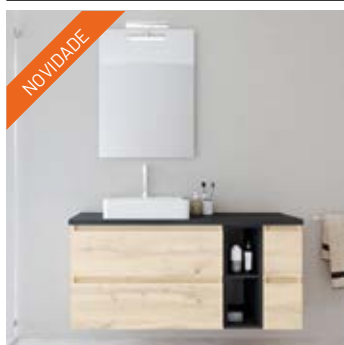

AML-M194-IV	PLAY V2 SUSPENSO 80-G2 HERCULES	280 250,00	319 485,00
AML-M170	PLAY V2 SUSPENSO 20-A AZABACHE	70 500,00	80 370,00
AML-M179-IV	PLAY V2 SUSPENSO 20-G2 HERCULES	168 250,00	191 805,00
AML-T120	PLAY TAMPO 120 AZABACHE	156 850,00	178 809,00
DAV-L042	DUATI LAVATÓRIO CERÂMICO 44x44	107 250,00	122 265,00
AML-E201	SIDNEY ESPELHO LISO 57x77	59 250,00	67 545,00
TOTAL CONJUNTO 120 cm		842 350,00	960 279,00

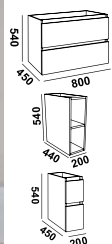

AML-M194-3V	PLAY V2 SUSPENSO 80-G2 CARVALHO	280 250,00	319 485,00
AML-M171	PLAY V2 SUSPENSO 20-A BRANCO	70 500,00	80 370,00
AML-M179-3V	PLAY V2 SUSPENSO 20-G2 CARVALHO	168 250,00	191 805,00
AML-T121	PLAY TAMPO 120 BRANCO	156 850,00	178 809,00
DAV-L042	DUATI LAVATÓRIO CERÂMICO 44x44	107 250,00	122 265,00
AML-E201	SIDNEY ESPELHO LISO 57x77	59 250,00	67 545,00
TOTAL CONJUNTO 120 cm		842 350,00	960 279,00

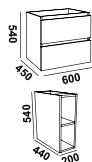
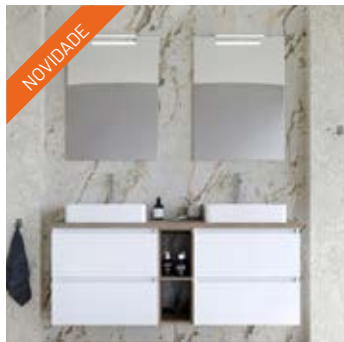

PLAY V2 140-G2 / MODULAR

AML-M186-V	PLAY V2 SUSPENSO 60-G2 BRANCO X2	496 500,00	566 010,00
AML-M174-3	PLAY V2 SUSPENSO 20-A CARVALHO	70 500,00	80 370,00
AML-T144-3	PLAY TAMPO 140 CARVALHO	176 250,00	200 925,00
DAV-L042	DUATI LAVATÓRIO CERÂMICO 44x44 X2	214 500,00	244 530,00
AML-E201	SIDNEY ESPELHO LISO 57x77 X2	118 500,00	135 090,00
TOTAL CONJUNTO 140 cm		1 076 250,00	1 226 925,00

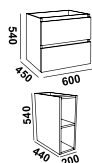
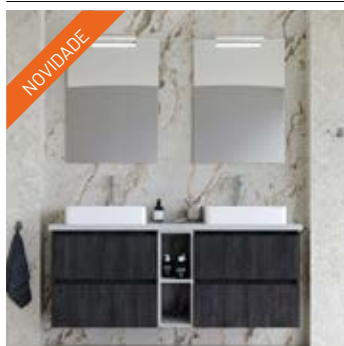

AML-M185-V	PLAY V2 SUSPENSO 60-G2 AZABACHE	496 500,00	566 010,00
AML-M174-2	PLAY V2 SUSPENSO 20-A CINZA	70 500,00	80 370,00
AML-T144-2	PLAY TAMPO 140 CINZA	176 250,00	200 925,00
DAV-L042	DUATI LAVATÓRIO CERÂMICO 44x44 X2	214 500,00	244 530,00
AML-E201	SIDNEY ESPELHO LISO 57x77 X2	118 500,00	135 090,00
TOTAL CONJUNTO 140 cm		1 076 250,00	1 226 925,00

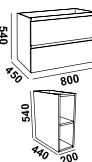
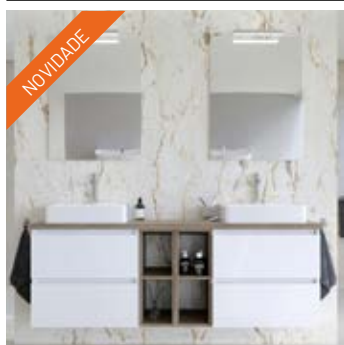

PLAY V2 160-G2 / MODULAR

AML-M186-V	PLAY V2 SUSPENSO 60-G2 BRANCO X2	496 500,00	566 010,00
AML-M174-3	PLAY V2 SUSPENSO 20-A CARVALHO X2	141 000,00	160 740,00
AML-T164-3	PLAY TAMPO 160 CARVALHO	208 250,00	237 405,00
DAV-L042	DUATI LAVATÓRIO CERÂMICO 44x44 X2	214 500,00	244 530,00
AML-E202	SIDNEY ESPELHO LISO 50x90 X2	137 700,00	156 978,00
TOTAL CONJUNTO 160 cm		1 197 950,00	1 365 663,00



AML-M191-V	PLAY V2 SUSPENSO 80-G2 BRANCO X2	560 500,00	638 970,00
AML-T164-1	PLAY TAMPO 160 HERCULES	208 250,00	237 405,00
DAV-L042	DUATI LAVATÓRIO CERÂMICO 44x44 X2	214 500,00	244 530,00
AML-E203	SIDNEY ESPELHO LISO 70x90 X2	179 500,00	204 630,00
AML-E204	SIDNEY ESPELHO LISO 80x90	96 250,00	109 725,00
TOTAL CONJUNTO 160 cm		1 162 750,00	1 325 535,00



PLAY V2 TAMPO 60

	AML-T060	PLAY TAMPO 60 AZABACHE	88 250,00	100 605,00
	AML-T061	PLAY TAMPO 60 BRANCO	88 250,00	100 605,00
	AML-T064-1	PLAY TAMPO 60 HERCULES	88 250,00	100 605,00
	AML-T064-2	PLAY TAMPO 60 CINZA	88 250,00	100 605,00
	AML-T064-3	PLAY TAMPO 60 CARVALHO	88 250,00	100 605,00
	AML-C102	PLAY SUPORTE 42x15 X2	224 500,00	255 930,00
	DAV-L042	DUATI LAVATÓRIO CERÂMICO 44x44	107 250,00	122 265,00
	AML-E201	SIDNEY ESPELHO LISO 57x77	59 250,00	67 545,00
TOTAL CONJUNTO 60 cm			479 250,00	546 345,00



PLAY V2 TAMPO 80

	AML-T080	PLAY TAMPO 80 AZABACHE	112 250,00	127 965,00
	AML-T081	PLAY TAMPO 80 BRANCO	112 250,00	127 965,00
	AML-T084-1	PLAY TAMPO 80 HERCULES	112 250,00	127 965,00
	AML-T084-2	PLAY TAMPO 80 CINZA	112 250,00	127 965,00
	AML-T084-3	PLAY TAMPO 80 CARVALHO	112 250,00	127 965,00
	AML-C102	PLAY SUPORTE 42x15 X2	224 500,00	255 930,00
	DAV-L042	DUATI LAVATÓRIO CERÂMICO 44x44	107 250,00	122 265,00
	AML-E201	SIDNEY ESPELHO LISO 57x77	59 250,00	67 545,00
TOTAL CONJUNTO 80 cm			503 250,00	573 705,00

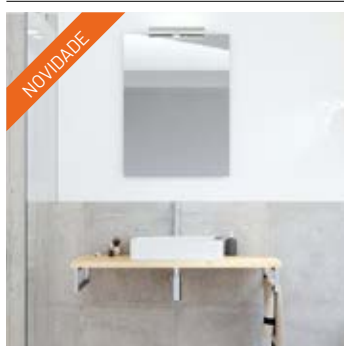

PLAY V2 TAMPO 100

	AML-T100	PLAY TAMPO 100 AZABACHE	136 250,00	155 325,00
	AML-T101	PLAY TAMPO 100 BRANCO	136 250,00	155 325,00
	AML-T104-1	PLAY TAMPO 100 HERCULES	136 250,00	155 325,00
	AML-T104-2	PLAY TAMPO 100 CINZA	136 250,00	155 325,00
	AML-T104-3	PLAY TAMPO 100 CARVALHO	136 250,00	155 325,00
	AML-C102	PLAY SUPORTE 42x15 X2	224 500,00	255 930,00
	DAV-L042	DUATI LAVATÓRIO CERÂMICO 44x44	107 250,00	122 265,00
	AML-E201	SIDNEY ESPELHO LISO 57x77	59 250,00	67 545,00
TOTAL CONJUNTO 100 cm			527 250,00	601 065,00

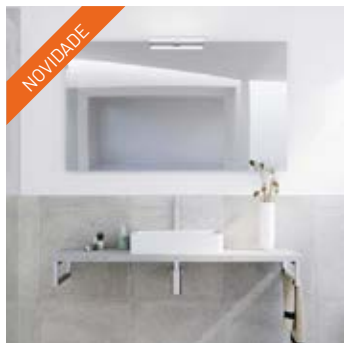

PLAY V2 TAMPO 120

	AML-T120	PLAY TAMPO 120 AZABACHE	156 850,00	178 809,00
	AML-T121	PLAY TAMPO 120 BRANCO	156 850,00	178 809,00
	AML-T124-1	PLAY TAMPO 120 HERCULES	156 850,00	178 809,00
	AML-T124-2	PLAY TAMPO 120 CINZA	156 850,00	178 809,00
	AML-T124-3	PLAY TAMPO 120 CARVALHO	156 850,00	178 809,00
	AML-C102	PLAY SUPORTE 42x15 X2	224 500,00	255 930,00
	DAV-L042	DUATI LAVATÓRIO CERÂMICO 44x44	107 250,00	122 265,00
	AML-E206	SIDNEY ESPELHO LISO 120x70	128 250,00	146 205,00
TOTAL CONJUNTO 120 cm			616 850,00	703 209,00

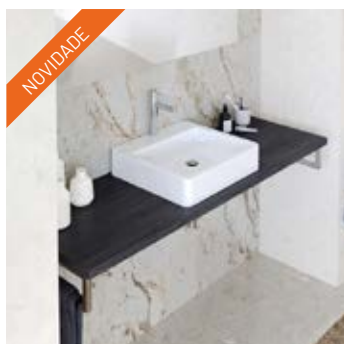

PLAY V2 TAMPO 140

	AML-T140	PLAY TAMPO 140 AZABACHE	176 250,00	200 925,00
	AML-T141	PLAY TAMPO 140 BRANCO	176 250,00	200 925,00
	AML-T144-1	PLAY TAMPO 140 HERCULES	176 250,00	200 925,00
	AML-T144-2	PLAY TAMPO 140 CINZA	176 250,00	200 925,00
	AML-T144-3	PLAY TAMPO 140 CARVALHO	176 250,00	200 925,00
	AML-C102	PLAY SUPORTE 42x15 X2	224 500,00	255 930,00
	DAV-L042	DUATI LAVATÓRIO CERÂMICO 44x44	107 250,00	122 265,00
	AML-E206	SIDNEY ESPELHO LISO 120x70	128 250,00	146 205,00
TOTAL CONJUNTO 140 cm			636 250,00	725 325,00

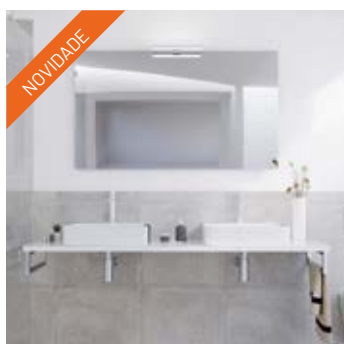

PLAY V2 TAMPO 160

	AML-T160	PLAY TAMPO 160 AZABACHE	208 250,00	237 405,00
	AML-T161	PLAY TAMPO 160 BRANCO	208 250,00	237 405,00
	AML-T164-1	PLAY TAMPO 160 HERCULES	208 250,00	237 405,00
	AML-T164-2	PLAY TAMPO 160 CINZA	208 250,00	237 405,00
	AML-T164-3	PLAY TAMPO 160 CARVALHO	208 250,00	237 405,00
	AML-C102	PLAY SUPORTE 42x15 X2	224 500,00	255 930,00
	DAV-L042	DUATI LAVATÓRIO CERÂMICO 44x44 X2	214 500,00	244 530,00
	AML-E206	SIDNEY ESPELHO LISO 120x70	128 250,00	146 205,00
TOTAL CONJUNTO 160 cm			775 500,00	884 070,00

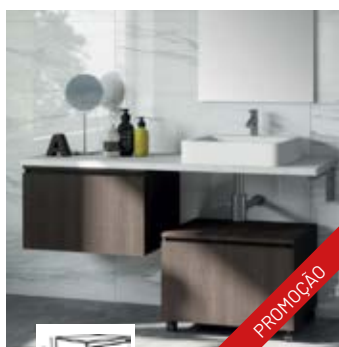

PLAY 60-G1

	AML-M180	PLAY MÓVEL SUSPENSO 60-G1 AZABACHE	150 125,00	171 142,50
	AML-M182	PLAY MÓVEL SUSPENSO 60-G1 ESTEPA	150 125,00	171 142,50
	AML-M183	PLAY MÓVEL SUSPENSO 60-G1 TAIGA	150 125,00	171 142,50
	AML-M184	PLAY MÓVEL SUSPENSO 60-G1 TEA	150 125,00	171 142,50
	AML-M184-1	PLAY MÓVEL SUSPENSO 60-G1 HERCULES	150 125,00	171 142,50
	AML-M184-2	PLAY MÓVEL SUSPENSO 60-G1 CINZA	150 125,00	171 142,50



AML-T062	PLAY TAMPO 60 ESTEPA	80 950,00	92 283,00
AML-T082	PLAY TAMPO 80 ESTEPA	102 950,00	117 363,00
AML-T102	PLAY TAMPO 100 ESTEPA	124 950,00	142 443,00
AML-T122	PLAY TAMPO 120 ESTEPA	144 950,00	165 243,00
AML-T142	PLAY TAMPO 140 ESTEPA	161 950,00	184 623,00
AML-T162	PLAY TAMPO 160 ESTEPA	191 950,00	218 823,00



AML-T083	PLAY TAMPO 80 TAIGA	102 950,00	117 363,00
AML-T103	PLAY TAMPO 100 TAIGA	124 950,00	142 443,00
AML-T143	PLAY TAMPO 140 TAIGA	161 950,00	184 623,00
AML-T163	PLAY TAMPO 160 TAIGA	191 950,00	218 823,00



AML-T064	PLAY TAMPO 60 TEA	80 950,00	92 283,00
AML-T084	PLAY TAMPO 80 TEA	102 950,00	117 363,00
AML-T104	PLAY TAMPO 100 TEA	124 950,00	142 443,00
AML-T124	PLAY TAMPO 120 TEA	144 950,00	165 243,00
AML-T144	PLAY TAMPO 140 TEA	161 950,00	184 623,00
AML-T164	PLAY TAMPO 160 TEA	191 950,00	218 823,00



PLAY 60 / 80-G3



AML-M195	PLAY MÓVEL 60-G3 BRANCO	322 750,00	367 935,00
-----------------	-------------------------	------------	-------------------



AML-M197	PLAY MÓVEL 80-G3 BRANCO	360 250,00	410 685,00
-----------------	-------------------------	------------	-------------------

AML-L102	FLATE LAVATÓRIO CERÂMICO 81x46	108 750,00	123 975,00
-----------------	--------------------------------	------------	-------------------

AML-E204	SIDNEY ESPELHO LISO 80x90	96 250,00	109 725,00
-----------------	---------------------------	-----------	-------------------

TOTAL CONJUNTO 80 cm		565 250,00	644 385,00
-----------------------------	--	------------	-------------------



AML-M196	PLAY MÓVEL 60-G3 AZABACHE	322 750,00	367 935,00
-----------------	---------------------------	------------	-------------------



AML-M198	PLAY MÓVEL 80-G3 AZABACHE	360 250,00	410 685,00
-----------------	---------------------------	------------	-------------------

AML-L101	FLATE LAVATÓRIO CERÂMICO 61x46	97 500,00	111 150,00
-----------------	--------------------------------	-----------	-------------------

AML-E201	SIDNEY ESPELHO LISO 57x77	59 250,00	67 545,00
-----------------	---------------------------	-----------	------------------

TOTAL CONJUNTO 60 cm		479 500,00	546 630,00
-----------------------------	--	------------	-------------------



SOLERO 60 WHITE

AML-M215	SOLERO MÓVEL 60 BRANCO	126 750,00	144 495,00
AML-L101	FLATE LAVATÓRIO CERÂMICO 61x46	97 500,00	111 150,00
AML-E050	CONTACT ESPELHO LED 60x90	224 250,00	255 645,00
TOTAL CONJUNTO 60 cm		448 500,00	511 290,00



SOLERO 80 WHITE

AML-M216	SOLERO MÓVEL 80 BRANCO	150 750,00	171 855,00
AML-L102	FLATE LAVATÓRIO CERÂMICO 81x46	108 750,00	123 975,00
AML-E204	SIDNEY ESPELHO LISO 80x90	96 250,00	109 725,00
TOTAL CONJUNTO 80 cm		355 750,00	405 555,00



SOLERO 80 MODULAR

AML-M215	SOLERO MÓVEL 60 BRANCO	126 750,00	144 495,00
AML-M174-3	PLAY V2 SUSPENSO 20-A CARVALHO	70 500,00	80 370,00
AML-T084-3	PLAY TAMPO 80 CARVALHO	112 250,00	127 965,00
DAV-L042	DUATI LAVÁTORIO CERÂMICO 44x44	107 250,00	122 265,00
AML-E201	SIDNEY ESPELHO LISO 57x77	59 250,00	67 545,00
TOTAL CONJUNTO 80 cm		476 000,00	542 640,00



SOLERO 100 MODULAR

AML-M215	SOLERO MÓVEL 60 BRANCO	126 750,00	144 495,00
AML-M174-3	PLAY V2 SUSPENSO 20-A CARVALHO	70 500,00	80 370,00
AML-M176-V	PLAY V2 SUSPENSO 20-G2 BRANCO	168 250,00	191 805,00
AML-T104-3	PLAY TAMPO 100 CARVALHO	136 250,00	155 325,00
DAV-L042	DUATI LAVÁTORIO CERÂMICO 44x44	107 250,00	122 265,00
AML-E204	SIDNEY ESPELHO LISO 80x90	96 250,00	109 725,00
TOTAL CONJUNTO 100 cm		705 250,00	803 985,00



SOLERO 120 MODULAR

AML-M216	SOLERO MÓVEL 80 BRANCO	150 750,00	171 855,00
AML-M174-3	PLAY V2 SUSPENSO 20-A CARVALHO	70 500,00	80 370,00
AML-M176-V	PLAY V2 SUSPENSO 20-G2 BRANCO	168 250,00	191 805,00
AML-T124-3	PLAY TAMPO 120 CARVALHO	156 850,00	178 809,00
DAV-L042	DUATI LAVÁTORIO CERÂMICO 44x44	107 250,00	122 265,00
AML-E206	SIDNEY ESPELHO LISO 120x70	128 250,00	146 205,00
TOTAL CONJUNTO 120 cm		781 850,00	891 309,00

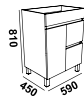

ZEUS 60 BRANCO

AML-M300	ZEUS MÓVEL 60 BRANCO	176 250,00	200 925,00
AML-L101	FLATE LAVATÓRIO CERÂMICO 61x46	97 500,00	111 150,00
AML-E201	SIDNEY ESPELHO LISO 57x77	59 250,00	67 545,00
TOTAL CONJUNTO 60 cm		333 000,00	379 620,00



ZEUS 80 BRANCO

AML-M301	ZEUS MÓVEL 80 BRANCO	208 250,00	237 405,00
AML-L102	FLATE LAVATÓRIO CERÂMICO 81x46	108 750,00	123 975,00
AML-E201	SIDNEY ESPELHO LISO 57x77	59 250,00	67 545,00
TOTAL CONJUNTO 80 cm		376 250,00	428 925,00

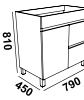

ZEUS 100 BRANCO

AML-M302	ZEUS MÓVEL 100 BRANCO	256 250,00	292 125,00
AML-L103	FLATE LAVATÓRIO CERÂMICO 101x46	162 500,00	185 250,00
AML-E204	SIDNEY ESPELHO LISO 80x90	96 250,00	109 725,00
TOTAL CONJUNTO 100 cm		515 000,00	587 100,00

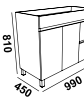

ZEUS 120 BRANCO

AML-M303	ZEUS MÓVEL 120 BRANCO	400 250,00	456 285,00
AML-L105	FLATE LAVATÓRIO CERÂMICO DUPLLO 121x46	242 250,00	276 165,00
AML-E206	SIDNEY ESPELHO LISO 120x70	128 250,00	146 205,00
TOTAL CONJUNTO 120 cm		770 750,00	878 655,00



ZEUS SUSPENSO 60 BRANCO

AML-M310	ZEUS MÓVEL SUSPENSO 60 BRANCO	168 250,00	191 805,00
AML-L101	FLATE LAVATÓRIO CERÂMICO 61x46	97 500,00	111 150,00
AML-E201	SIDNEY ESPELHO LISO 57x77	59 250,00	67 545,00
TOTAL CONJUNTO 60 cm		325 000,00	370 500,00



ZEUS SUSPENSO 80 BRANCO

AML-M311	ZEUS MÓVEL SUSPENSO 80 BRANCO	192 250,00	219 165,00
AML-L102	FLATE LAVATÓRIO CERÂMICO 81x46	108 750,00	123 975,00
AML-E201	SIDNEY ESPELHO LISO 57x77	59 250,00	67 545,00
TOTAL CONJUNTO 80 cm		360 250,00	410 685,00



ZEUS SUSPENSO 100 BRANCO

AML-M312	ZEUS MÓVEL SUSPENSO 100 BRANCO	280 250,00	319 485,00
AML-L103	FLATE LAVATÓRIO CERÂMICO 101x46	162 500,00	185 250,00
AML-E204	SIDNEY ESPELHO LISO 80x90	96 250,00	109 725,00
TOTAL CONJUNTO 100 cm		539 000,00	614 460,00



ZEUS SUSPENSO 120 BRANCO

AML-M313	ZEUS MÓVEL SUSPENSO 120 BRANCO	320 250,00	365 085,00
AML-L104	FLATE LAVATÓRIO CERÂMICO 121x46	230 750,00	263 055,00
AML-E206	SIDNEY ESPELHO LISO 120x70	128 250,00	146 205,00
TOTAL CONJUNTO 120 cm		679 250,00	774 345,00

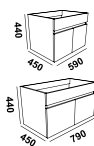

ANIDIS 60 / 80 BRANCO

AML-M001	ANIDIS MÓVEL 60 BRANCO	108 950,00	124 203,00
AML-M004	ANIDIS MÓVEL 80 BRANCO	128 250,00	146 205,00
AML-L101	FLATE LAVATÓRIO CERÂMICO 61x46	97 500,00	111 150,00
AML-E201	SIDNEY ESPELHO LISO 57x77	59 250,00	67 545,00
TOTAL CONJUNTO 60 cm		265 700,00	302 898,00

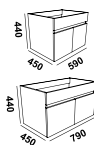

ANIDIS 60 / 80 HERCULES

AML-M003-1	ANIDIS MÓVEL 60 HERCULES	108 950,00	124 203,00
AML-M006-1	ANIDIS MÓVEL 80 HERCULES	128 250,00	146 205,00
AML-L101	FLATE LAVATÓRIO CERÂMICO 61x46	97 500,00	111 150,00
AML-E201	SIDNEY ESPELHO LISO 57x77	59 250,00	67 545,00
TOTAL CONJUNTO 60 cm		265 700,00	302 898,00

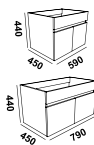

ANIDIS 60 / 80 CINZA

AML-M003-2	ANIDIS MÓVEL 60 CINZA	108 950,00	124 203,00
AML-M006-2	ANIDIS MÓVEL 80 CINZA	128 250,00	146 205,00
AML-L102	FLATE LAVATÓRIO CERÂMICO 81x46	108 750,00	123 975,00
AML-E201	SIDNEY ESPELHO LISO 57x77	59 250,00	67 545,00
TOTAL CONJUNTO 80 cm		296 250,00	337 725,00



ANIDIS 80 HERCULES



AML-M006-1	ANIDIS MÓVEL 80 HERCULES	128 250,00	146 205,00
AML-T081	PLAY TAMPO 80 BRANCO	112 250,00	127 965,00
AML-L201	SIMPLE LAVÁTORIO CERÂMICO 40 PRETO	237 500,00	270 750,00
AML-E150	MOON ESPELHO C/ AUMENTO 70	128 250,00	146 205,00
TOTAL CONJUNTO 80 cm		606 250,00	691 125,00



ANIDIS 120 CINZA

AML-M003-2	ANIDIS MÓVEL 60 CINZA X2	217 900,00	248 406,00
AML-L105	FLATE LAVATÓRIO CERÂMICO DUPLO 121x46	242 250,00	276 165,00
AML-E202	SIDNEY ESPELHO LISO 50x90 X2	137 700,00	156 978,00
TOTAL CONJUNTO 120 cm		597 850,00	681 549,00



ANIDIS 160 BRANCO

AML-M004	ANIDIS MÓVEL 80 BRANCO X2	256 500,00	292 410,00
AML-T164-2	PLAY TAMPO 160 CINZA	208 250,00	237 405,00
DAV-L042	DUATI LAVATÓRIO CERÂMICO 44x44 X2	214 500,00	244 530,00
AML-E129	MADRID ESPELHO 60x80 BRANCO X2	208 500,00	237 690,00
TOTAL CONJUNTO 160 cm		887 750,00	1 012 035,00



ECO 50 BRANCO



AML-M050

ECO CONJUNTO MÓVEL 50 BRANCO
MÓVEL + LAVÁTORIO + ESPELHO

264 250,00

301 245,00

ECO 60 BRANCO



AML-M051

ECO MÓVEL 60 BRANCO

136 250,00

155 325,00

AML-L101

FLATE LAVATÓRIO CERÂMICO 61x46

97 500,00

111 150,00

AML-E201

SIDNEY ESPELHO LISO 57x77

59 250,00

67 545,00

TOTAL CONJUNTO 60 cm

293 000,00

334 020,00

ECO 80 BRANCO



AML-M052

ECO MÓVEL 80 BRANCO

156 950,00

178 923,00

AML-L102

FLATE LAVATÓRIO CERÂMICO 81x46

108 750,00

123 975,00

AML-E201

SIDNEY ESPELHO LISO 57x77

59 250,00

67 545,00

TOTAL CONJUNTO 80 cm



324 950,00

370 443,00



FUNDO REDUZIDO 21,5 CM

MINI 40/60/80 BRANCO

	AML-M130	MINI MÓVEL 40 + LAVÁTORIO BRANCO	159 950,00	182 343,00
	AML-E200	SIDNEY ESPELHO LISO 42x66	48 250,00	55 005,00
TOTAL CONJUNTO 40 cm			208 200,00	237 348,00
	AML-M132	MINI MÓVEL 60 + LAVÁTORIO BRANCO	226 250,00	257 925,00
	AML-E201	SIDNEY ESPELHO LISO 57x77	59 250,00	67 545,00
TOTAL CONJUNTO 60 cm			285 500,00	325 470,00
	AML-M132-1	MINI MÓVEL 80 + LAVÁTORIO BRANCO	274 250,00	312 645,00
	AML-E201	SIDNEY ESPELHO LISO 57x77	59 250,00	67 545,00
TOTAL CONJUNTO 80 cm			333 500,00	380 190,00



FUNDO REDUZIDO 35 CM

MINI 40/60/80 BRANCO - ESTEPA

	AML-M131	MINI MÓVEL 40 + LAVÁTORIO BRANCO / ESTEPA	159 950,00	182 343,00
	AML-E200	SIDNEY ESPELHO LISO 42x66	48 250,00	55 005,00
TOTAL CONJUNTO 40 cm			208 200,00	237 348,00
	AML-M133	MINI MÓVEL 60 + LAVÁTORIO BRANCO / ESTEPA	226 250,00	257 925,00
	AML-E201	SIDNEY ESPELHO LISO 57x77	59 250,00	67 545,00
TOTAL CONJUNTO 60 cm			285 500,00	325 470,00
	AML-M133-1	MINI MÓVEL 80 + LAVÁTORIO BRANCO / ESTEPA	274 250,00	312 645,00
	AML-E201	SIDNEY ESPELHO LISO 57x77	59 250,00	67 545,00
TOTAL CONJUNTO 80 cm			333 500,00	380 190,00

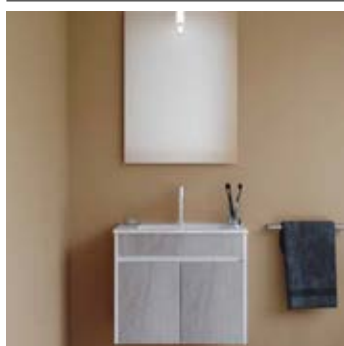

FUNDO REDUZIDO 35 CM

MINI 40 / 60 / 80 BRANCO - CINZA

	AML-M131-1	MINI MÓVEL 40 + LAVÁTORIO BRANCO / CINZA	159 950,00	182 343,00
	AML-E200	SIDNEY ESPELHO LISO 42x66	48 250,00	55 005,00
TOTAL CONJUNTO 40 cm			208 200,00	237 348,00
	AML-M134	MINI MÓVEL 60 + LAVÁTORIO BRANCO / CINZA	226 250,00	257 925,00
	AML-E201	SIDNEY ESPELHO LISO 57x77	59 250,00	67 545,00
TOTAL CONJUNTO 60 cm			285 500,00	325 470,00
	AML-M134-1	MINI MÓVEL 80 + LAVÁTORIO BRANCO / CINZA	274 250,00	312 645,00
	AML-E201	SIDNEY ESPELHO LISO 57x77	59 250,00	67 545,00
TOTAL CONJUNTO 80 cm			333 500,00	380 190,00



PLAY 60-G2

	AML-M187	PLAY MOVÉL 60-G2 ESTEPA	187 525,00	213 778,50
	AML-M188	PLAY MOVÉL 60-G2 TAIGA	187 525,00	213 778,50
	AML-M189	PLAY MOVÉL 60-G2 TEA	187 525,00	213 778,50
	AML-L101	FLATE LAVATÓRIO CERÂMICO 61x46	97 500,00	111 150,00
	AML-E201	SIDNEY ESPELHO LISO 57x77	59 250,00	67 545,00
TOTAL CONJUNTO 60 cm			344 275,00	392 473,50



PLAY 80-G2

	AML-M192	PLAY MOVÉL 80-G2 ESTEPA	217 525,00	247 978,50
	AML-M193	PLAY MOVÉL 80-G2 TAIGA	217 525,00	247 978,50
	AML-M194	PLAY MOVÉL 80-G2 TEA	217 525,00	247 978,50
	AML-L102	FLATE LAVATÓRIO CERÂMICO 81x46	108 750,00	123 975,00
	AML-E201	SIDNEY ESPELHO LISO 57x77	59 250,00	67 545,00
TOTAL CONJUNTO 80 cm			385 525,00	439 498,50

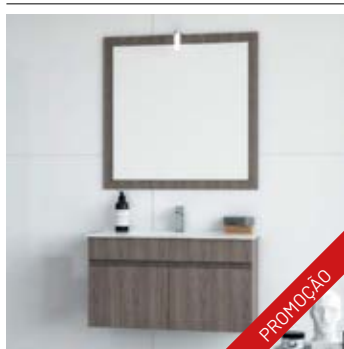

ANIDIS 60

	AML-M002	ANIDIS MÓVEL 60 ESTEPA	103 525,00	118 018,50
	AML-M003	ANIDIS MÓVEL 60 WENGUE	103 525,00	118 018,50
	AML-L101	FLATE LAVATÓRIO CERÂMICO 61x46	97 500,00	111 150,00
	AML-E201	SIDNEY ESPELHO LISO 57x77	59 250,00	67 545,00
TOTAL CONJUNTO 60 cm			260 275,00	296 713,50



FUNDO REDUZIDO 39 CM

FIT 50



AML-M060 FIT MÓVEL 50 BRANCO + LAVATÓRIO 255 125,00 **290 842,50**

AML-E200 SIDNEY ESPELHO LISO 42x66 48 250,00 **55 005,00**

TOTAL CONJUNTO 50 cm 303 375,00 **345 847,50**



AML-M061 FIT MÓVEL 50 HERCULES + LAVATÓRIO 255 125,00 **290 842,50**

AML-E200 SIDNEY ESPELHO LISO 42x66 48 250,00 **55 005,00**

TOTAL CONJUNTO 50 cm 303 375,00 **345 847,50**

KIBALA 60

265.366 KIBALA MÓVEL SUSPENSO 60 FAIA 98 950,00 **112 803,00**

AML-L101 FLATE LAVATÓRIO CERÂMICO 61x46 97 500,00 **111 150,00**

AML-E201 SIDNEY ESPELHO LISO 57x77 59 250,00 **67 545,00**

TOTAL CONJUNTO 60 cm 255 700,00 **291 498,00**



STATUS 65

265.630 STATUS MÓVEL SUSPENSO 75-G1 FAIA 198 950,00 **226 803,00**

265.631 STATUS COLUNA SUSPENSA C/ TOALHEIRO 198 950,00 **226 803,00**

DAV-L042 DUATI LAVATÓRIO CERÂMICO 44x44 107 250,00 **122 265,00**

AML-E202 SIDNEY ESPELHO LISO 50x90 68 850,00 **78 489,00**

TOTAL CONJUNTO 75 cm 375 050,00 **427 557,00**

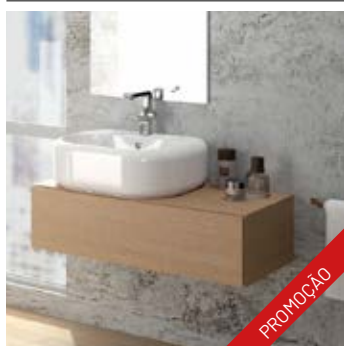



HUAMBO 80 CEREJEIRA

265.310	HUAMBO MÓVEL 80 CEREJEIRA	128 950,00	147 003,00
AML-L102	FLATE LAVATÓRIO CERÂMICO 81x46	108 750,00	123 975,00
135.200	HUAMBO ESPELHO 80 CEREJEIRA	68 950,00	78 603,00
TOTAL CONJUNTO 80 cm		306 650,00	349 581,00



GLAM 80 VERMELHO / BRANCO

265.275	GLAM MÓVEL 80 VERMELHO / BRANCO	248 950,00	283 803,00
AML-L039	BEM LAVATÓRIO VIDRO VERMELHO 81x46	194 750,00	222 015,00
135.180	GLAM ESPELHO 80 VERMELHO	98 950,00	112 803,00
TOTAL CONJUNTO 80 cm		542 650,00	618 621,00



GAVELA 85 VERMELHO / BRANCO

265.295	GAVELA MÓVEL 85 VERMELHO / BRANCO	248 950,00	283 803,00
265.065	GAVELA COLUNA VERMELHO / BRANCO	248 950,00	283 803,00
DAV-L124	LENUS LAVATÓRIO CERÂMICO OVAL 41	81 250,00	92 625,00
135.170	GAVELA ESPELHO VERMELHO / BRANCO	98 950,00	112 803,00
TOTAL CONJUNTO 85 cm		429 150,00	489 231,00

**SHAIRA 80 PRETO ROSA**

265.633	SHAIRA MÓVEL 80 PRETO / ROSA	248 950,00	283 803,00
AML-L036	BEM LAVATÓRIO VIDRO PRETO 81x46	194 750,00	222 015,00
135.110	CACULO ESPELHO 80 PRETO	128 950,00	147 003,00
TOTAL CONJUNTO 80 cm		572 650,00	652 821,00

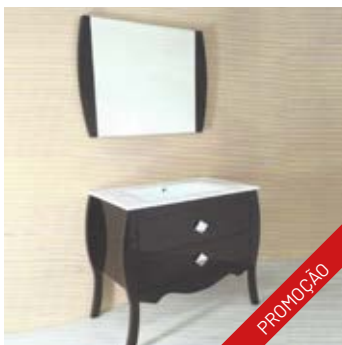
**CACULO 80 PRETO**







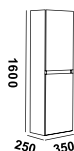

265.179	CACULO MÓVEL 80 PRETO	248 950,00	283 803,00
AML-L102	FLATE LAVATÓRIO CERÂMICO 81x46	108 750,00	123 975,00
135.110	CACULO ESPELHO 80 PRETO	128 950,00	147 003,00
TOTAL CONJUNTO 80 cm		486 650,00	554 781,00

**N'ZETO 80 VERMELHO**

265.501	N'ZETO MÓVEL 80 VERMELHO	248 950,00	283 803,00
AML-L036	BEM LAVATÓRIO VIDRO PRETO 81x46	194 750,00	222 015,00
135.416	N'ZETO ESPELHO 80 VERMELHO	128 950,00	147 003,00
TOTAL CONJUNTO 80 cm		572 650,00	652 821,00



PLAY SUSPENSO 35

	AML-M510	PLAY COLUNA SUSPENSA 35 AZABACHE	198 250,00	226 005,00
	AML-M511	PLAY COLUNA SUSPENSA 35 BRANCO	198 250,00	226 005,00
	AML-M512	PLAY COLUNA SUSPENSA 35 ESTEPA	198 250,00	226 005,00
	AML-M513	PLAY COLUNA SUSPENSA 35 TAIGA	198 250,00	226 005,00
	AML-M514	PLAY COLUNA SUSPENSA 35 TEA	198 250,00	226 005,00
	AML-M514-1	PLAY COLUNA SUSPENSA 35 HERCULES	198 250,00	226 005,00
	AML-M514-2	PLAY COLUNA SUSPENSA 35 CINZA	198 250,00	226 005,00
	AML-M514-3	PLAY COLUNA SUSPENSA 35 CARVALHO	198 250,00	226 005,00



ZEUS AUXILIARES

AML-M540 ZEUS COLUNA 40x182 BRANCO 296 250,00 **337 725,00**

AML-M541 ZEUS COLUNA C/ TULHA 40x182 BRANCO 344 250,00 **392 445,00**

AML-M544 ZEUS COLUNA 60x182 BRANCO 384 250,00 **438 045,00**

AML-M545 ZEUS COLUNA C/ TULHA 60x182 BRANCA 424 250,00 **483 645,00**

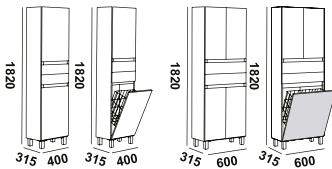

AML-M542 ZEUS COLUNA 40x182 WENGUE 277 525,00 **316 378,50**

AML-M543 ZEUS COLUNA C/ TULHA 40x182 WENGUE 322 525,00 **367 678,50**

AML-M546 ZEUS COLUNA 60x182 WENGUE 360 125,00 **410 542,50**

AML-M547 ZEUS COLUNA C/ TULHA 60x182 WENGUE 397 525,00 **453 178,50**

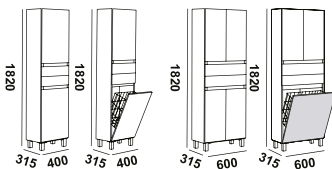

AML-M580 ZEUS MESITA 40x82 BRANCA 160 875,00 **183 397,50**



AML-M582 ZEUS MESITA C/ TULHA 40x82 BRANCA 208 250,00 **237 405,00**



AML-M581 ZEUS MESITA 40x82 WENGUE 160 875,00 **183 397,50**



AML-M583 ZEUS MESITA C/ TULHA 40x82 BRANCA 208 250,00 **237 405,00**



CITY BAIXO

AML-M031	CITY MÓVEL BAIXO 60 WENGUE	96 750,00	110 295,00
AML-M031-1	CITY MOVÉL BAIXO 70 WENGUE	96 750,00	110 295,00
AML-M033	CITY MOVÉL BAIXO 80 WENGUE	108 950,00	124 203,00
AML-M032	CITY MOVÉL BAIXO 80 BRANCO	108 950,00	124 203,00



CAMERINOS

AML-E030	CAMERINO ESPELHO 40-1 P BRANCO	121 750,00	138 795,00
AML-E032	CAMERINO ESPELHO 60-1 P BRANCO	142 750,00	162 735,00
AML-E032-1	CAMERINO ESPELHO 60-2 P BRANCO	176 750,00	201 495,00
AML-E036	CAMERINO ESPELHO 80-2 P BRANCO	216 750,00	247 095,00



AML-E033	CAMERINO ESPELHO 60-1 P WENGUE	142 750,00	162 735,00
AML-E037	CAMERINO ESPELHO 80-2 P WENGUE	216 750,00	247 095,00
AML-E039	CAMERINO ESPELHO 80-2P C/ ESTANTES WENGUE	216 750,00	247 095,00



EGO

265.045	EGO COLUNA C/ VITRINE WENGUE 60 cm	198 950,00	226 803,00
----------------	------------------------------------	------------	-------------------



MOVIMAR

265.074	MOVIMAR COLUNA 160 AMBERES / WENGUE	148 950,00	169 803,00
----------------	-------------------------------------	------------	-------------------

265.075	MOVIMAR COLUNA 160 WENGUE / AMBERES	148 950,00	169 803,00
----------------	-------------------------------------	------------	-------------------

265.076	MOVIMAR COLUNA 160 VERMELHO / WENGUE	148 950,00	169 803,00
----------------	--------------------------------------	------------	-------------------

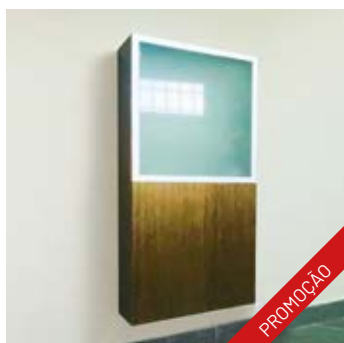

IKO

265.009	IKO MÓVEL COLUNA SUSPENSA 60x124 WENGUE	129 950,00	148 143,00
----------------	---	------------	-------------------



NAU APOIO

265.490	NAU MÓVEL APOIO 40 NOGUEIRA	98 950,00	112 803,00
----------------	-----------------------------	-----------	-------------------



ATOMO LED



RB-E005

ATOMO ESPELHO LED / 100 cm

960 250,00

1 094 885,00



PULSE LED



RB-E160

PULSE ESPELHO LED / 140x60 cm

640 250,00

729 885,00



CLUB 3D LED

EFEITO 3D



RB-E030

CLUB 3D ESPELHO LED / 79x65 cm

664 250,00

757 245,00



INFINIT 3D LED

EFEITO 3D



RB-E031

INFINIT 3D ESPELHO LED / 62 cm

736 250,00

839 325,00



ADNET BLACK LED



RB-E010

ADNET ESPELHO LED BLACK / 60 cm

988 750,00

1 127 175,00



ADNET BROWN LED



RB-E011

ADNET ESPELHO LED BROWN / 60 cm

988 750,00

1 127 175,00



PULSE LED



RB-E161

PULSE ESPELHO LED / 90 cm

536 250,00

611 325,00



VÓRTICE LED



AML-E250

VÓRTICE ESPELHO LED / 57x77 cm

435 250,00

496 185,00



BOREAL LED



AML-E021

BOREAL ESPELHO LED / 120x70 cm

368 250,00

419 805,00

AML-E020

BOREAL ESPELHO LED / 80x70 cm

336 250,00

383 325,00



CONTACT LED



AML-E050

CONTACT ESPELHO LED / 60x90 cm

224 250,00

255 645,00

AML-E051

CONTACT ESPELHO LED / 80x90 cm

256 250,00

292 125,00

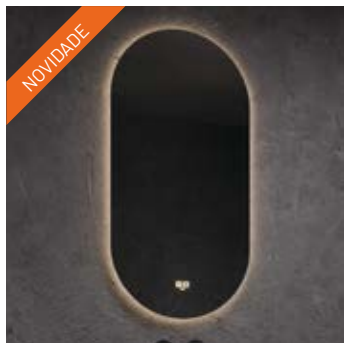

AURA LED



BM-E010	AURA ESPELHO LED / 50x100 cm	320 250,00	365 085,00
----------------	------------------------------	------------	-------------------



FRAME LED



BM-E061	FRAME ESPELHO LED / 80x70 cm	267 250,00	304 665,00
----------------	------------------------------	------------	-------------------

BM-E062	FRAME ESPELHO LED / 100x70 cm	312 250,00	355 965,00
----------------	-------------------------------	------------	-------------------

BM-E063	FRAME ESPELHO LED / 120x70 cm	344 250,00	392 445,00
----------------	-------------------------------	------------	-------------------

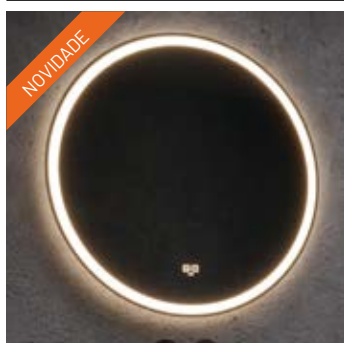

MOON LED



BM-E130	MOON ESPELHO LED / 60 cm	230 750,00	263 055,00
----------------	--------------------------	------------	-------------------

BM-E131	MOON ESPELHO LED / 80 cm	304 250,00	346 845,00
----------------	--------------------------	------------	-------------------

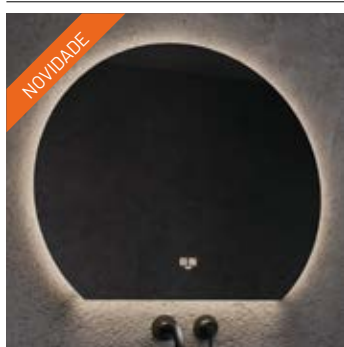

SUNSET LED



BM-E190	SUNSET ESPELHO LED / 60 cm	186 250,00	212 325,00
----------------	----------------------------	------------	-------------------

BM-E191	SUNSET ESPELHO LED / 80 cm	232 250,00	264 765,00
----------------	----------------------------	------------	-------------------



BARI LED



AML-E015	BARI ESPELHO LED WHITE / 60x70 cm	432 250,00	492 765,00
AML-E016	BARI ESPELHO LED BLACK / 60x70 cm	432 250,00	492 765,00



LOOK C/ AUMENTO



AML-E120	LOOK ESPELHO C/ AUMENTO / 57x77 cm	120 250,00	137 085,00
-----------------	------------------------------------	------------	-------------------



MOON C/ AUMENTO



AML-E150	MOON ESPELHO C/ AUMENTO / 70 cm	128 250,00	146 205,00
-----------------	---------------------------------	------------	-------------------



SIDNEY



AML-E200	SIDNEY ESPELHO LISO / 42x66 cm	48 250,00	55 005,00
AML-E201	SIDNEY ESPELHO LISO / 57x77 cm	59 250,00	67 545,00
AML-E202	SIDNEY ESPELHO LISO / 50x90 cm	68 850,00	78 489,00
AML-E203	SIDNEY ESPELHO LISO / 70x90 cm	89 750,00	102 315,00
AML-E204	SIDNEY ESPELHO LISO / 80x90 cm	96 250,00	109 725,00
AML-E206	SIDNEY ESPELHO LISO / 120x70 cm	128 250,00	146 205,00



MADRID BRANCO

AML-E129	MADRID ESPELHO BRANCO / 60x80 cm	104 250,00	118 845,00
AML-E130	MADRID ESPELHO BRANCO / 80x80 cm	136 250,00	155 325,00
AML-E131	MADRID ESPELHO BRANCO / 100x80 cm	176 250,00	200 925,00
AML-E132	MADRID ESPELHO BRANCO / 120x80 cm	199 250,00	227 145,00



MADRID WENGUE

AML-E136	MADRID ESPELHO WENGUE / 80x80 cm	136 250,00	155 325,00
AML-E137	MADRID ESPELHO WENGUE / 100x80 cm	176 250,00	200 925,00
AML-E138	MADRID ESPELHO WENGUE / 120x80 cm	199 250,00	227 145,00

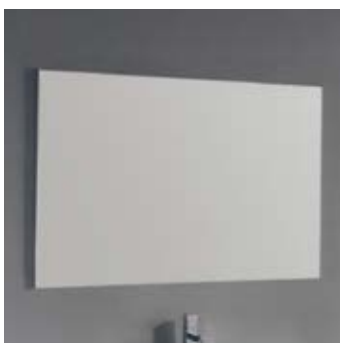

LIFA BRANCO

DAV-E061	LIFA ESPELHO BRANCO / 60x80 cm	72 250,00	82 365,00
DAV-E062	LIFA ESPELHO BRANCO / 80x80 cm	88 250,00	100 605,00
DAV-E063	LIFA ESPELHO BRANCO / 100x80 cm	96 250,00	109 725,00
DAV-E064	LIFA ESPELHO BRANCO / 120x80 cm	144 250,00	164 445,00



BAILUNDO C/ ARMARIO

135.095	BAILUNDO ESPELHO C/ ARMARIO BRANCO RISCAS 100 cm	128 950,00	147 003,00
----------------	---	------------	-------------------



LOBITO CEREJEIRA

135.355

LOBITO ESPELHO CEREJEIRA / 50 cm

68 950,00

78 603,00



PLAN

135.470

PLAN ESPELHO C/ ILUMINAÇÃO / 75 cm

128 950,00

147 003,00



VINTAGE

135.625

VINTAGE CAMERINO C/ ILUMINAÇÃO / 52 cm

198 950,00

226 803,00



NAU

135.410

NAU ESPELHO NOGUEIRA / 100 cm

128 950,00

147 003,00



PROMOÇÃO

RÍVER

135.490

RÍVER ESPELHO C/ MOLDURA PRATA / 80x70 cm

128 950,00

147 003,00



PROMOÇÃO

WCA C/ ILUMINAÇÃO

135.650

WCA ESPELHO C/ ILUMINAÇÃO / 60 cm

128 950,00

147 003,00



PROMOÇÃO

ROSMA

135.500

ROSMA ESPELHO REDONDO / 60 cm

28 950,00

33 003,00



PROMOÇÃO

ZESTE

135.700

ZESTE ESPELHO REDONDO / 60 cm

28 950,00

33 003,00

OVAL



135.440

OVAL ESPELHO / 75x45 cm

28 950,00

33 003,00

DREAM



135.132

DREAM ESPELHO C/ MODURA INOX / 80x60 cm

28 950,00

33 003,00

CAMEL



135.109

CAMEL ESPELHO C/ MODURA INOX / 80x60 cm

28 950,00

33 003,00

HUGO

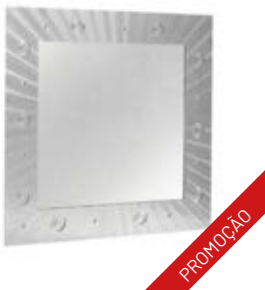

135.203

HUGO ESPELHO C/ MODURA INOX / 70x70 cm

28 950,00

33 003,00



PROMOÇÃO

STRIPPY

135.570

STRIPPY ESPELHO / 70x50 cm

28 950,00

33 003,00



PROMOÇÃO

GIO

135.175

GIO ESPELHO / 70x50 cm

28 950,00

33 003,00



PROMOÇÃO

VALOVA

135.615

VALOVA BLUE ESPELHO / 70x50 cm

28 950,00

33 003,00



PROMOÇÃO

10411

135.800

10411 ESPELHO / 70x50 cm

28 950,00

33 003,00



PROMOÇÃO

STYLUS

135.575	STYLUS ESPELHO / 70x50 cm	28 950,00	33 003,00
---------	---------------------------	-----------	-----------



PROMOÇÃO

NUVEM

135.430	NUVEM ESPELHO LISO / 65x45 cm	28 950,00	33 003,00
---------	-------------------------------	-----------	-----------



PROMOÇÃO

PEIXE

135.460	PEIXE ESPELHO LISO / 70x27 cm	28 950,00	33 003,00
---------	-------------------------------	-----------	-----------



NOVIDADE



AML-E002	VERONICA APLIQUE CROMADO	52 850,00	60 249,00
----------	--------------------------	-----------	-----------



AML-E003	VERONICA APLIQUE PRETO	64 250,00	73 245,00
----------	------------------------	-----------	-----------



SUPORTES

AML-C101-1	SELENE CONJUNTO / 80 cm CONJUNTO= LAVÁTORIO + SUPORTE + ESPELHO + SIFÃO + VALVULA CLIC CLAC	348 950,00	397 803,00
-------------------	---	------------	-------------------



AML-C100	SELENE SUPORTE P/ LAVÁTORIO 60	158 500,00	180 690,00
-----------------	--------------------------------	------------	-------------------

AML-C101	SELENE SUPORTE P/ LAVÁTORIO 80	162 500,00	185 250,00
-----------------	--------------------------------	------------	-------------------



AML-C102	PLAY SUPORTE 1 und.	112 250,00	127 965,00
-----------------	---------------------	------------	-------------------



AML-C103	GLAMOUR SUPORTE 1 und.	80 250,00	91 485,00
-----------------	------------------------	-----------	------------------



PES

AML-C202	QUADRA KIT PÉS BRANCO / 2 und.	128 250,00	146 205,00
-----------------	--------------------------------	------------	-------------------

AML-C203	QUADRA KIT PÉS PRETO / 2 und.	128 250,00	146 205,00
-----------------	-------------------------------	------------	-------------------



AML-C204	PLAY PÉS CROMADOS 10cm / 4 Und.	12 950,00	14 763,00
-----------------	---------------------------------	-----------	------------------

AML-C205	PLAY PÉS CROMADOS 25cm / 2 Und.	12 950,00	14 763,00
-----------------	---------------------------------	-----------	------------------



AML-C206	PLAY KIT RODAS 4 Und.	28 950,00	33 003,00
-----------------	-----------------------	-----------	------------------



The background of the entire page is a dark field filled with numerous out-of-focus, multi-colored light spots (bokeh) in shades of white, yellow, blue, and red. In the top right corner, the logo 'dama' is displayed in a white, lowercase, sans-serif font. The letter 'a' is highlighted in orange. A thin orange horizontal line is positioned directly beneath the 'a' and extends slightly to the right.

dama

LAVATÓRIOS



GUN METAL

RB-L075	GUN METAL LAVATÓRIO CINZA ESCURO	763 750,00	870 675,00
RB-T070/G	GUN METAL MONOCOMANDO C/ PRATELEIRA	756 750,00	862 695,00

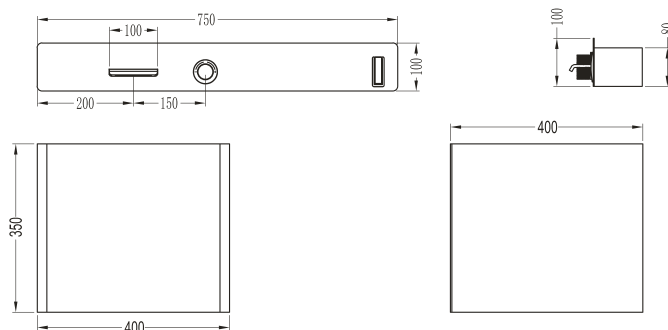

STUNNING SOLID SURFACE

RB-L195	STUNNING LAVATÓRIO SOLID SURFACE PRETO MATE	1 868 750,00	2 130 375,00
----------------	---	--------------	---------------------

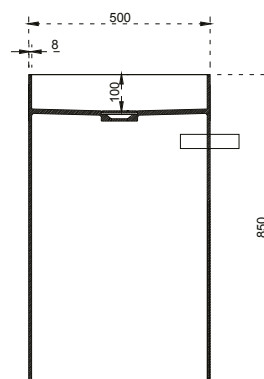

RANE CERÂMICO BRANCO

RB-L175	RANE LAVATÓRIO CERÂMICO BRANCO	812 500,00	926 250,00
----------------	--------------------------------	------------	-------------------

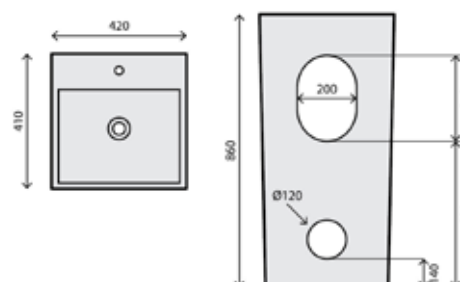



BOL GOLD

RB-L026

LAVATÓRIO VIDRO

243 750,00

277 875,00

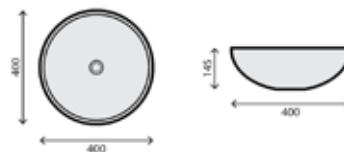

BOL BLACK & GOLD

RB-L027

LAVATÓRIO VIDRO

284 375,00

324 187,50

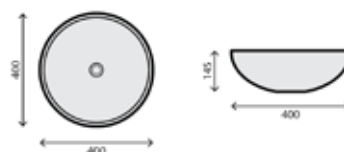

BOL SILVER

RB-L028

LAVATÓRIO VIDRO

243 750,00

277 875,00

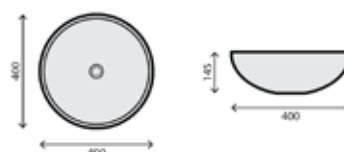

BOL BLACK & SILVER

RB-L029

LAVATÓRIO VIDRO

284 375,00

324 187,50

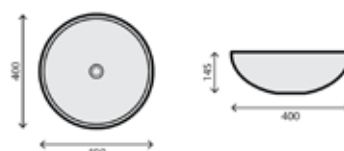

BOL WHITE

RB-L025

LAVATÓRIO CERÂMICO

121 875,00

138 937,50

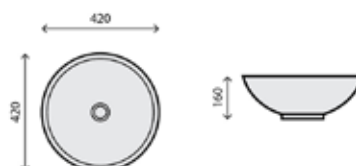



FORMA BLACK & WHITE

RB-L061

LAVATÓRIO CERÂMICO

243 750,00

277 875,00

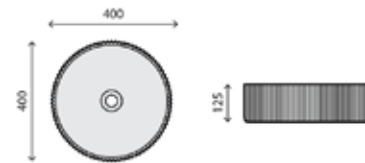

FORMA GOLD & BLACK

RB-L062

LAVATÓRIO CERÂMICO

284 375,00

324 187,50

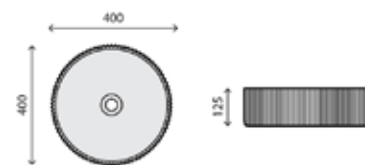

FORMA WHITE MATE

RB-L060

LAVATÓRIO CERÂMICO

243 750,00

277 875,00

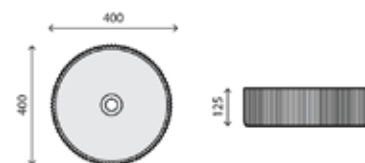

CUBIC GOLD & WHITE

RB-L035

LAVATÓRIO CERÂMICO

203 125,00

231 562,50



CUBIC SILVER & WHITE

RB-L036

LAVATÓRIO CERÂMICO

203 125,00

231 562,50





ESTRELA GOLD & WHITE

RB-L050

LAVATÓRIO CERÂMICO

243 750,00

277 875,00

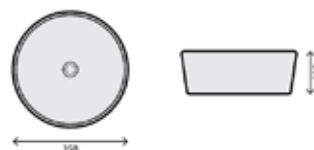

ESTRELA SILVER & WHITE

RB-L051

LAVATÓRIO CERÂMICO

243 750,00

277 875,00

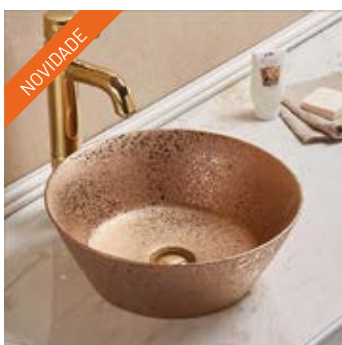
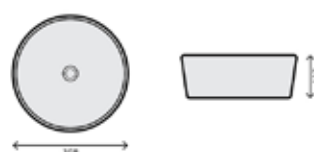

GOTAS BRONZE

RB-L070

LAVATÓRIO CERÂMICO

203 125,00

231 562,50

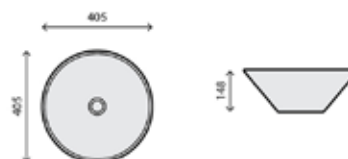

GOTAS SILVER

RB-L071

LAVATÓRIO CERÂMICO

203 125,00

231 562,50

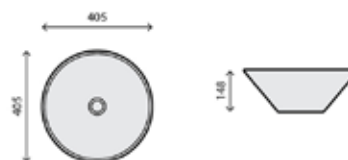

GOTAS GOLD

RB-L072

LAVATÓRIO CERÂMICO

203 125,00

231 562,50

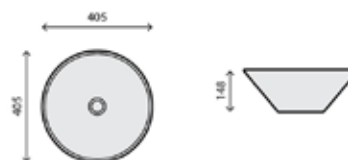

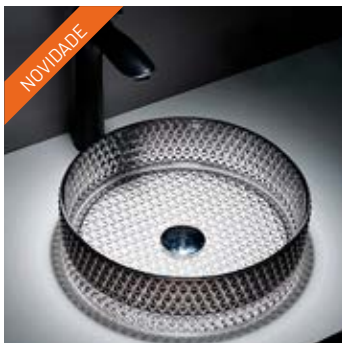

GLASS BLACK

RB-L076

LAVATÓRIO VIDRO

324 750,00

370 215,00

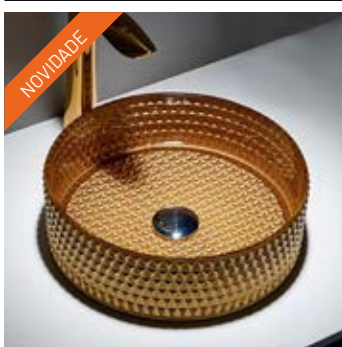
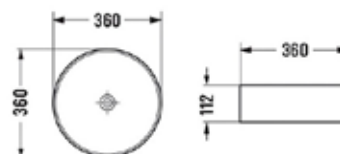

GLASS GOLD

RB-L076-1

LAVATÓRIO VIDRO

324 750,00

370 215,00

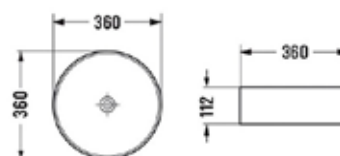

ROMANTIC BLACK & WHITE

RB-L185

LAVATÓRIO CERÂMICO

243 750,00

277 875,00

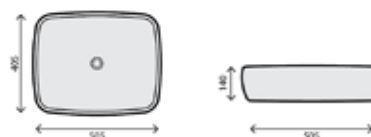

RETRO WHITE & BLACK

RB-L180

LAVATÓRIO CERÂMICO

243 750,00

277 875,00

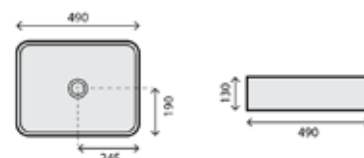

RETRO OVAL WHITE & BLACK

RB-L181

LAVATÓRIO CERÂMICO

243 750,00

277 875,00

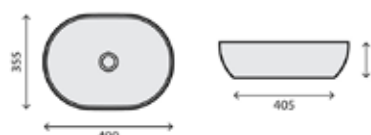



SALAT BLACK

RB-L191

LAVATÓRIO CERÂMICO

211 250,00

240 825,00

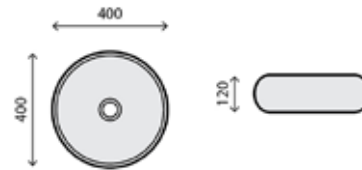

SALAT WHITE

RB-L190

LAVATÓRIO CERÂMICO

162 500,00

185 250,00

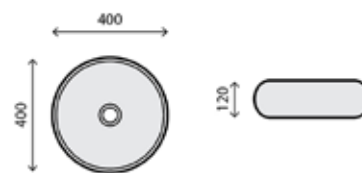

CLASIC A

RB-L030

LAVATÓRIO CERÂMICO

128 750,00

146 775,00

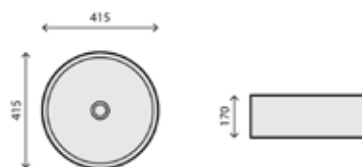

CLASIC B

RB-L031

LAVATÓRIO CERÂMICO

128 750,00

146 775,00

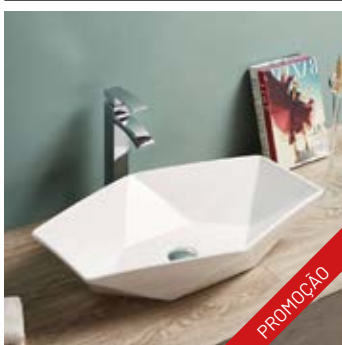
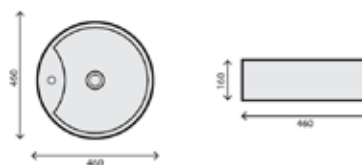

HEXÁGONO RECTANGULAR

RB-L080

LAVATÓRIO CERÂMICO

195 250,00

222 585,00

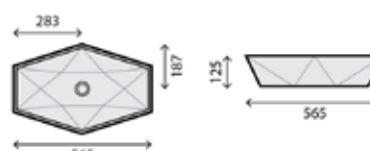



BOHEMIC PRETO MATE

RB-L022/P

LAVATÓRIO CERÂMICO

227 500,00

259 350,00

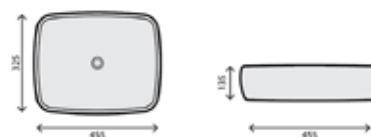

BOHEMIC CINZA ESCURO MATE

RB-L022/CE

LAVATÓRIO CERÂMICO

196 250,00

223 725,00

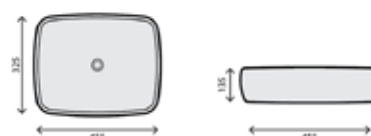

BOHEMIC CINZA MATE

RB-L022/C

LAVATÓRIO CERÂMICO

196 250,00

223 725,00

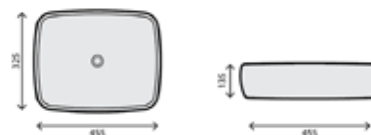

BOHEMIC CAPPUCCINO MATE

RB-L022/CP

LAVATÓRIO CERÂMICO

243 750,00

277 875,00

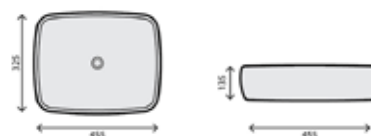

BOHEMIC BRANCO MATE

RB-L022/B

LAVATÓRIO CERÂMICO

196 250,00

223 725,00

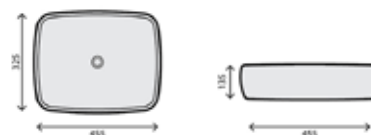



LENUS 60 WHITE

DAV-L120

LAVATÓRIO CERÂMICO

123 500,00

140 790,00



LENUS 50 WHITE

DAV-L120-1

LAVATÓRIO CERÂMICO

107 250,00

122 265,00

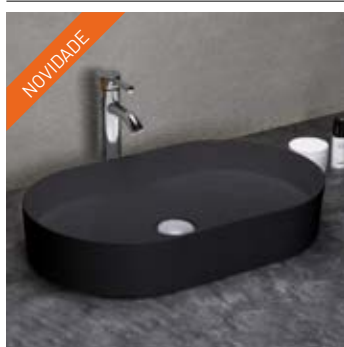
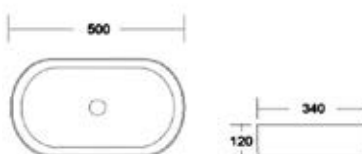

LENUS 50 BLACK

DAV-L121-1

LAVATÓRIO CERÂMICO

211 250,00

240 825,00

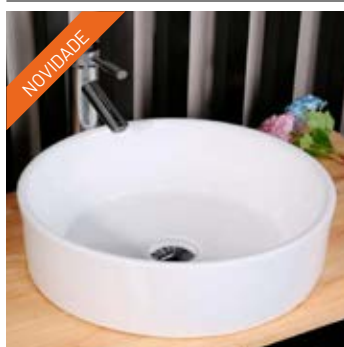
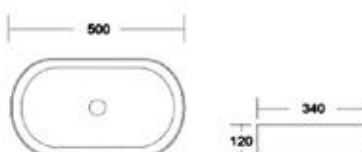

LENUS 35 WHITE / WHITE MATE

DAV-L122

LAVATÓRIO CERÂMICO WHITE BRILHO

100 750,00

114 855,00

NOVIDADE

DAV-L122-1

LAVATÓRIO CERÂMICO WHITE MATE

178 750,00

203 775,00

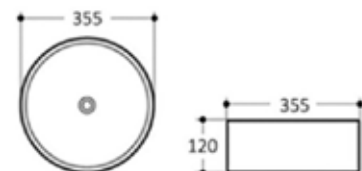

LENUS 35 BLACK MATE

DAV-L123

LAVATÓRIO CERÂMICO

178 750,00

203 775,00

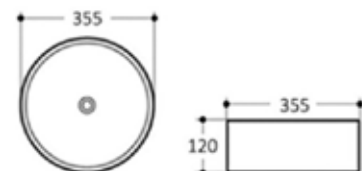



SABIA 50 WHITE

DAV-L190 LAVATÓRIO CERÂMICO 108 750,00 **123 975,00**

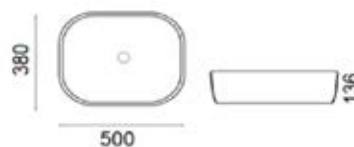

SABIA 50 BLACK

DAV-L191 LAVATÓRIO CERÂMICO 211 250,00 **240 825,00**

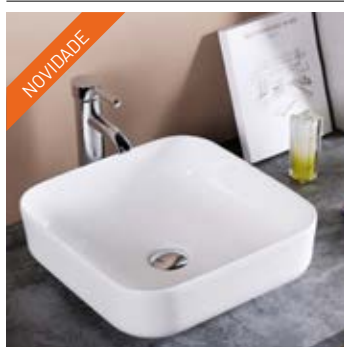
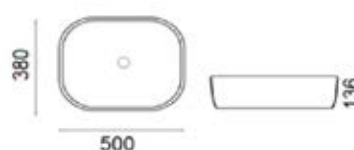

SABIA 39 WHITE / WHITE MATE

DAV-L192 LAVATÓRIO CERÂMICO WHITE BRILHO 100 750,00 **114 855,00**

NOVIDADE **DAV-L192-1** LAVATÓRIO CERÂMICO WHITE MATE 178 950,00 **204 003,00**

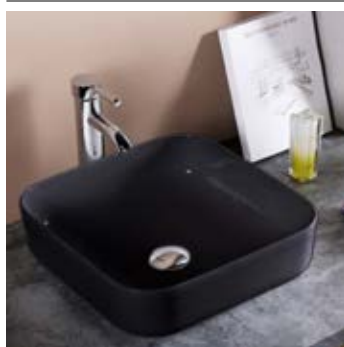
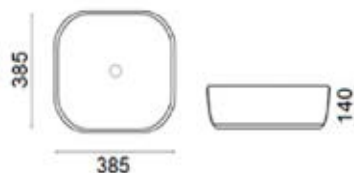

SABIA 39 BLACK

DAV-L193 LAVATÓRIO CERÂMICO 178 750,00 **203 775,00**

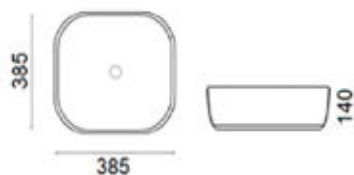

LENUS OVAL

DAV-L124 LAVATÓRIO CERÂMICO 81 250,00 **92 625,00**

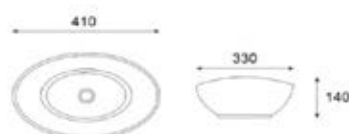



A2 WHITE

CF-L015

LAVATÓRIO CERÂMICO

86 750,00

98 895,00

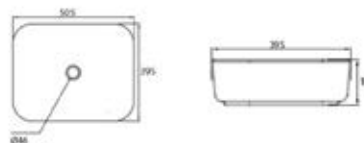

A2S WHITE

CF-L016

LAVATÓRIO CERÂMICO

104 750,00

119 415,00

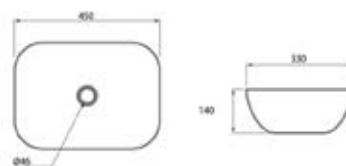

A2R WHITE

CF-L017

LAVATÓRIO CERÂMICO

84 750,00

96 615,00

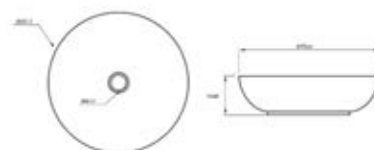

F3

CF-L061

LAVATÓRIO CERÂMICO

159 250,00

181 545,00

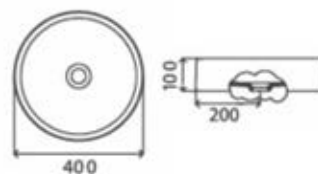

TECHNO C1 / 46

165.690

LAVATÓRIO CERÂMICO

159 250,00

181 545,00

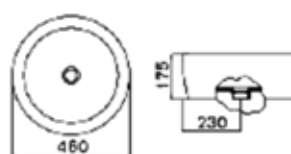



DUATI 40

DAV-L040

LAVATÓRIO CERÂMICO

97 500,00

111 150,00

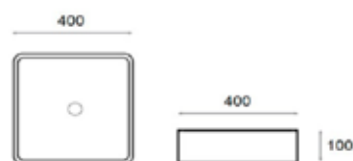

DUATI 50

DAV-L041

LAVATÓRIO CERÂMICO

110 500,00

125 970,00

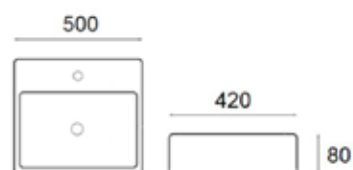

DUATI 44

DAV-L042

LAVATÓRIO CERÂMICO

107 250,00

122 265,00

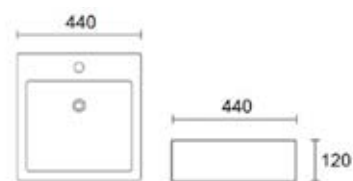

DUATI 40

DAV-L043

LAVATÓRIO CERÂMICO

104 250,00

118 845,00

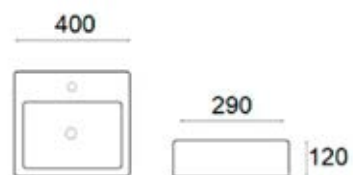

DUATI 33

DAV-L044

LAVATÓRIO CERÂMICO

97 500,00

111 150,00

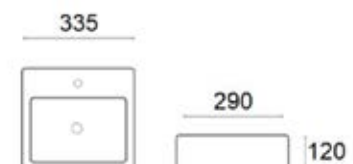



CADAQUES 50X46

CF-L025

LAVATÓRIO CERÂMICO

159 250,00

181 545,00

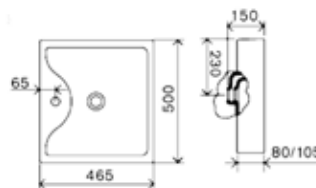

JOIN

165.425

LAVATÓRIO CERÂMICO

198 750,00

226 575,00

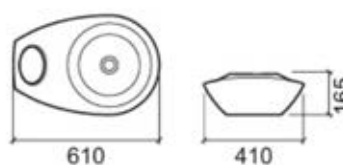

COMPACT 42X36

CF-L030

LAVATÓRIO CERÂMICO

130 250,00

148 485,00

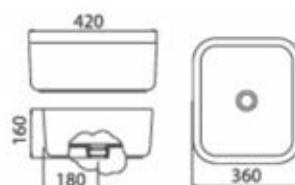

NOTE 36

165.530

LAVATÓRIO CERÂMICO

198 950,00

226 803,00

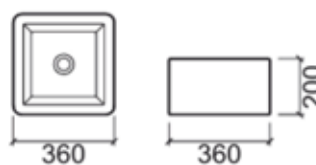

NOTE 100 / 2F

165.534

LAVATÓRIO CERÂMICO

298 950,00

340 803,00

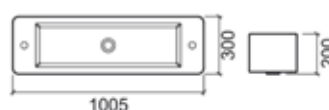



PROMOÇÃO

TOPPER 34

165.693

LAVATÓRIO CERÂMICO

81 250,00

92 625,00



PROMOÇÃO

F7 CANTO

CF-L068

LAVATÓRIO CERÂMICO

113 750,00

129 675,00

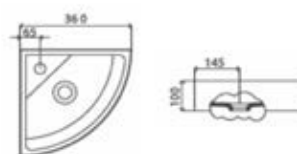

PROMOÇÃO

MORFYS AZUL

165.460

LAVATÓRIO CERÂMICO

298 950,00

340 803,00

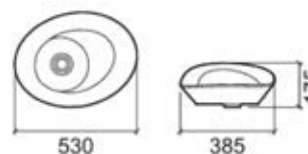

PROMOÇÃO

MORFYS VERMELHO

165.470

LAVATÓRIO CERÂMICO

298 950,00

340 803,00

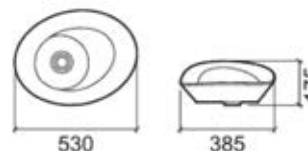

PROMOÇÃO

MORFYS VERDE

165.472

LAVATÓRIO CERÂMICO

298 950,00

340 803,00

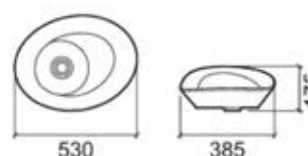



PROMOÇÃO

ALGARVE 56X46

CF-L010

LAVATÓRIO CERÂMICO

78 250,00

89 205,00

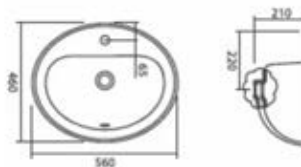

PROMOÇÃO

DAMA WHITE

RB-L040

LAVATÓRIO CERÂMICO

146 250,00

166 725,00

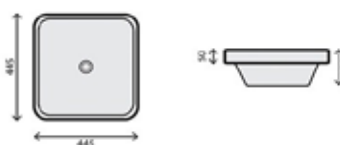

BAIXO WHITE

RB-L020

LAVATÓRIO CERÂMICO

130 250,00

148 485,00

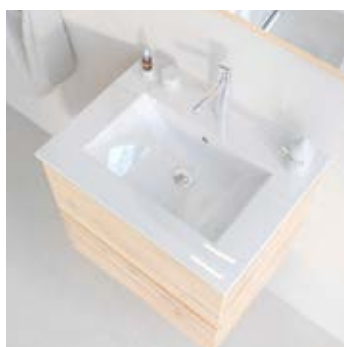
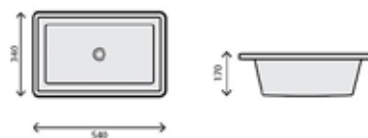

FLATE WHITE / 60-80-100-120

AML-L101

LAVATÓRIO CERÂMICO 61x46

97 500,00

111 150,00

AML-L102

LAVATÓRIO CERÂMICO 81x46

108 750,00

123 975,00

AML-L103

LAVATÓRIO CERÂMICO 101x46

162 500,00

185 250,00

AML-L104

LAVATÓRIO CERÂMICO 121x46

230 750,00

263 055,00



FLATE WHITE DUPLO 120

AML-L105

LAVATÓRIO CERÂMICO DUPLO 121x46

242 250,00

276 165,00



FLATE BLACK / 80-100

AML-L102/P	LAVATÓRIO CERÂMICO PRETO MATE 81x46	162 500,00	185 250,00
AML-L103/P	LAVATÓRIO CERÂMICO PRETO MATE 101x46	227 500,00	259 350,00



ELITE WHITE / 80-100-120

AML-L070	ELITE L LAVATÓRIO CERÂMICO ESQUERDO 81x46	203 125,00	231 562,50
AML-L072	ELITE L LAVATÓRIO CERÂMICO ESQUERDO 101x46	341 250,00	389 025,00
AML-L074	ELITE L LAVATÓRIO CERÂMICO ESQUERDO 121x46	479 375,00	546 487,50
AML-L071	ELITE R LAVATÓRIO CERÂMICO DIREITO 81x46	203 125,00	231 562,50
AML-L073	ELITE R LAVATÓRIO CERÂMICO DIREITO 101x46	341 250,00	389 025,00
AML-L075	ELITE R LAVATÓRIO CERÂMICO DIREITO 121x46	479 375,00	546 487,50



CHANEL WHITE / 60-80-100-120-120 DUPLO

AML-L050	CHANEL LAVATÓRIO CERÂMICO 61x46	154 375,00	175 987,50
AML-L051	CHANEL LAVATÓRIO CERÂMICO 81x46	186 875,00	213 037,50
AML-L052	CHANEL LAVATÓRIO CERÂMICO 101x46	276 250,00	314 925,00
AML-L053	CHANEL LAVATÓRIO CERÂMICO 121x46	446 875,00	509 437,50
AML-L054	CHANEL LAVATÓRIO CERÂMICO DUPLO 121x46	479 375,00	546 487,50





SUPRA WHITE / 80-100

AML-L195	SUPRA LAVATÓRIO CERÂMICO 81x46	159 250,00	181 545,00
AML-L196	SUPRA LAVATÓRIO CERÂMICO 100x46	243 750,00	277 875,00

COMPATÍVEL COM MÓVÉIS JOTA

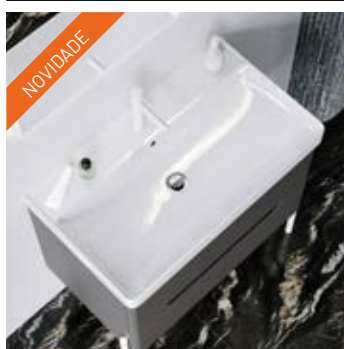

FUSION WHITE / 80-100

AML-L065	FUSION LAVATÓRIO CERÂMICO 81x47	195 250,00	222 585,00
AML-L066	FUSION LAVATÓRIO CERÂMICO 100x47	292 500,00	333 450,00

COMPATÍVEL COM MÓVÉIS JOTA



RUN WHITE FUNDO REDUZIDO / 60-80

AML-L190	RUN LAVATÓRIO CERÂMICO 61x36	113 750,00	129 675,00
AML-L191	RUN LAVATÓRIO CERÂMICO 81x36	146 250,00	166 725,00

COMPATÍVEL COM MÓVÉIS MINI



BEM VIDRO AZUL

AML-L021	BEM LAVATÓRIO VIDRO AZUL 81x46	194 750,00	222 015,00
AML-L022	BEM LAVATÓRIO VIDRO AZUL 101x46	243 750,00	277 875,00



BEM VIDRO BRANCO

AML-L023	BEM LAVATÓRIO VIDRO BRANCO 61x46	160 875,00	183 397,50
AML-L025	BEM LAVATÓRIO VIDRO BRANCO 101x46	243 750,00	277 875,00



PROMOÇÃO

BEM VIDRO LARANJA

AML-L026	BEM LAVATÓRIO VIDRO LARANJA 61x46	160 875,00	183 397,50
AML-L027	BEM LAVATÓRIO VIDRO LARANJA 81x46	194 750,00	222 015,00
AML-L028	BEM LAVATÓRIO VIDRO LARANJA 101x46	243 750,00	277 875,00



PROMOÇÃO

BEM VIDRO LILAS

AML-L029	BEM LAVATÓRIO VIDRO LILAS 61x46	160 875,00	183 397,50
AML-L031	BEM LAVATÓRIO VIDRO LILAS 101x46	243 750,00	277 875,00



PROMOÇÃO

BEM VIDRO PISTACHO

AML-L032	BEM LAVATÓRIO VIDRO PISTACHO 61x46	160 875,00	183 397,50
AML-L033	BEM LAVATÓRIO VIDRO PISTACHO 81x46	194 750,00	222 015,00
AML-L034	BEM LAVATÓRIO VIDRO PISTACHO 101x46	243 750,00	277 875,00



PROMOÇÃO

BEM VIDRO PRETO

AML-L035	BEM LAVATÓRIO VIDRO PRETO 61x46	160 875,00	183 397,50
AML-L036	BEM LAVATÓRIO VIDRO PRETO 81x46	194 750,00	222 015,00



PROMOÇÃO

BEM VIDRO VERMELHO

AML-L039	BEM LAVATÓRIO VIDRO VERMELHO 81x46	194 750,00	222 015,00
AML-L040	BEM LAVATÓRIO VIDRO VERMELHO 101x46	243 750,00	277 875,00



PROMOÇÃO

BEM VIDRO PRATA

165.117	BEM LAVATÓRIO VIDRO PRATA 101x46	243 750,00	277 875,00
----------------	----------------------------------	------------	-------------------

**SIFÕES LAVATÓRIO**

SE-210	SIFÃO QUADRADO LATÃO / CROMADO	45 500,00	51 870,00
SE-220	SIFÃO REDONDO LATÃO / BRANCO MATE	54 250,00	61 845,00
SE-221	SIFÃO REDONDO LATÃO / CROMADO	29 250,00	33 345,00
SE-222	SIFÃO REDONDO LATÃO / DOURADO	55 250,00	62 985,00
SE-223	SIFÃO REDONDO LATÃO / PRETO MATE	54 750,00	62 415,00

**PROMOÇÃO****VALVULAS CLIC CLAC CERÂMICAS**

SE-522	VALVULA REDONDA / PRETO MATE	40 750,00	46 455,00
SE-523	VALVULA REDONDA / PRETO BRILHO	40 750,00	46 455,00

**VALVULAS CLIC CLAC LATÃO**

SE-532	VALVULA QUADRADA / CROMADO	20 750,00	23 655,00
SE-530	VALVULA REDONDA / BRANCO MATE	23 950,00	27 303,00
SE-531	VALVULA REDONDA / CROMADO	12 950,00	14 763,00
SE-533	VALVULA REDONDA / DOURADO	23 950,00	27 303,00
SE-534	VALVULA REDONDA / PRETO MATE	23 950,00	27 303,00

**SIFÕES EXTENSÍVEIS C/ VALVULA**

SE-203	SIFÃO ESTENSIVEL / VALVULA SIMPLES 1-1/4	4 750,00	5 415,00
SE-204	SIFÃO ESTENSIVEL / VALVULA CLIC CLAC 1-1/4	13 325,00	15 190,50

**SIFÕES EXTENSÍVEIS C/ VALVULA**

SE-200	SIFÃO ESTENSIVEL 1-1/4 BRANCO	1 950,00	2 223,00
SE-201	SIFÃO ESTENSIVEL 1-1/4 CROMADO	3 975,00	4 531,50

**PARAFUSOS LAVATÓRIO**

SE-150	PARAFUSOS LAVATÓRIO / 2 und.	1 650,00	1 881,00
---------------	------------------------------	----------	-----------------



dama

SANITÁRIOS



BOHEMIC PRETO MATE

RB-BH01-P BOHEMIC PACK SANITA / SANITA + TANQUE + TAMPO SOFT CLOSE CLIP OFF 732 250,00 **834 765,00**

RB-BH07-P BOHEMIC BIDÉ COMPACTO 456 250,00 **520 125,00**

RB-L022/P BOHEMIC LAVATÓRIO POU SAR 455x325mm 227 500,00 **259 350,00**

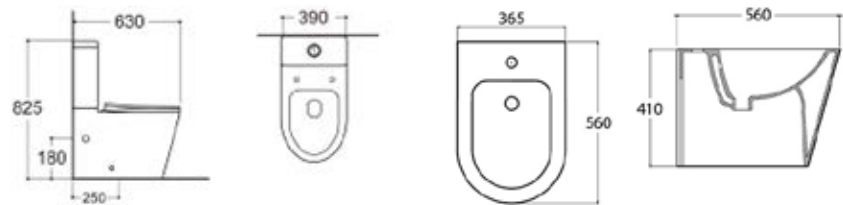

ELEGANT PRETO MATE

RB-EL02-1 ELEGANT SANITA SUSPENSA + TAMPO SOFT CLOSE CLIP OFF 488 750,00 **557 175,00**

RB-EL08-1 ELEGANT BIDÉ SUSPENSO 424 750,00 **484 215,00**





FLY CAPPUCINO MATE

RB-FY01-C	FLY PACK SANITA / SANITA + TANQUE + TAMPO SOFT CLOSE CLIP OFF	732 250,00	834 765,00
RB-FY07-C	FLY BIDÉ COMPACTO	456 250,00	520 125,00
RB-L022/CP	BOHEMIC LAVATÓRIO POUSAR 455x325mm	243 750,00	277 875,00

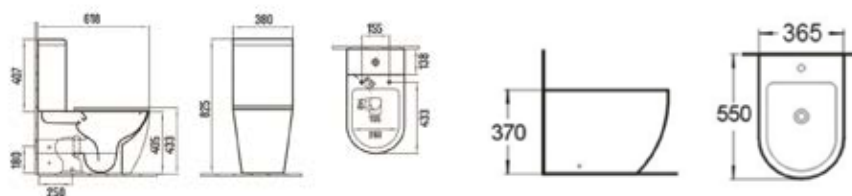

FLY SUSPENSO CAPPUCINO MATE

RB-FY02-C	FLY SANITA SUSPENSA + TAMPO SOFT CLOSE CLIP OFF	488 750,00	557 175,00
RB-FY08-C	FLY BIDÉ SUSPENSO	424 750,00	484 215,00

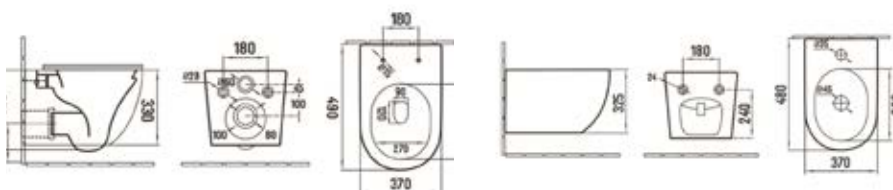



GLAMIC CINZA MATE

RB-GL01-C GLAMIC PACK SANITA / SANITA + TANQUE + TAMPO SOFT CLOSE CLIP OFF 732 250,00 **834 765,00**

RB-GL07-C GLAMIC BIDÉ COMPACTO 456 250,00 **520 125,00**

RB-L022/C BOHEMIC LAVATÓRIO POUSAR 455x325mm 196 250,00 **223 725,00**

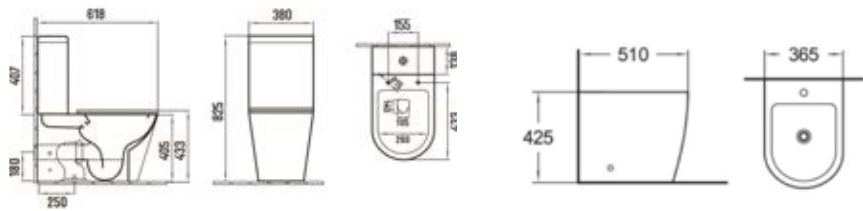

GLAMIC SUSPENSO CINZA

RB-GL02-C GLAMIC SANITA SUSPENSA + TAMPO SOFT CLOSE CLIP OFF 488 750,00 **557 175,00**

RB-GL08-C GLAMIC BIDÉ SUSPENSO 424 750,00 **484 215,00**

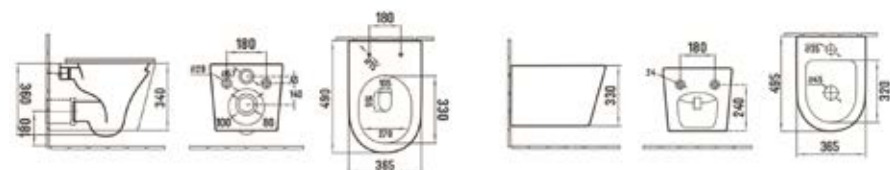



ELEGANT CINZA ESCURO MATE

RB-EL01-C ELEGANT PACK SANITA / SANITA + TANQUE + TAMPO SOFT CLOSE CLIP OFF 732 250,00 **834 765,00**

RB-EL07-C ELEGANT BIDÉ COMPACTO 456 250,00 **520 125,00**

RB-L022/CE BOHEMIC LAVATÓRIO POUSAR 455x325mm 196 250,00 **223 725,00**

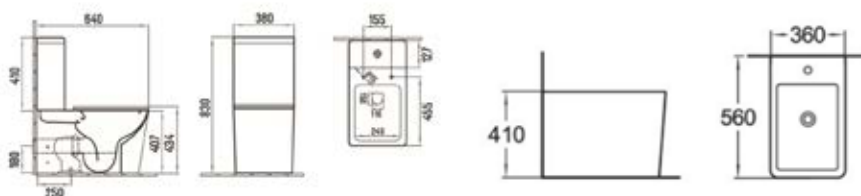

BOHEMIC BRANCO MATE

RB-BH01-B BOHEMIC PACK SANITA / SANITA + TANQUE + TAMPO SOFT CLOSE CLIP OFF 658 750,00 **750 975,00**

RB-BH07-M BOHEMIC BIDÉ COMPACTO 412 750,00 **470 535,00**

RB-L022/B BOHEMIC LAVATÓRIO POUSAR 455x325mm 196 250,00 **223 725,00**

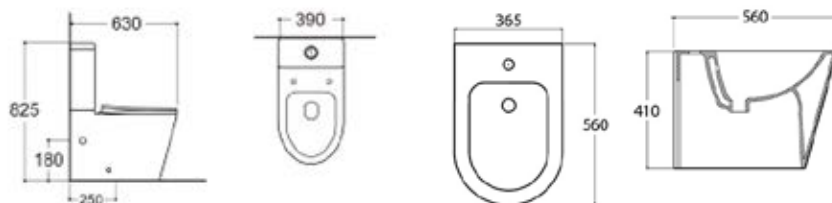



R2 BRANCO

CF-R201 R2 PACK SANITA / SANITA + TANQUE + TAMPO SOFT CLOSE CLIP OFF 412 750,00 **470 535,00**

CF-R207 R2 BIDÉ COMPACTO 248 750,00 **283 575,00**

CF-L016 A2S LAVATÓRIO POU SAR 455x395mm 104 750,00 **119 415,00**

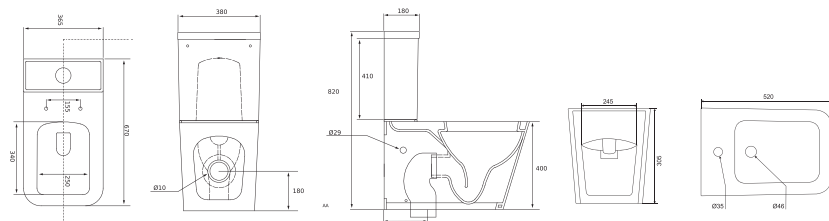

R2 SUSPENSO BRANCO

CF-R202 R2 SANITA SUSPENSA + TAMPO SOFT CLOSE CLOSE CLIP OFF 322 750,00 **367 935,00**

CF-R208 R2 BIDÉ SUSPENSO 278 750,00 **317 775,00**

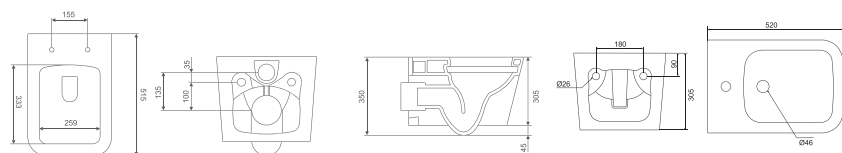



A2 BRANCO

CF-A201 A2 PACK SANITA / SANITA + TANQUE + TAMPO SOFT CLOSE CLIP OFF 358 750,00 **408 975,00**

CF-A207 A2 BIDÉ COMPACTO 218 750,00 **249 375,00**

CF-L017 A2R LAVATÓRIO POUJAR 415mm 84 750,00 **96 615,00**

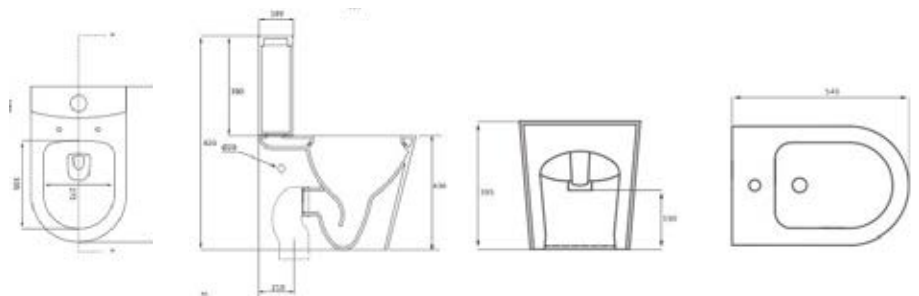

A2 SUSPENSO BRANCO

CF-A202 A2 SANITA SUSPENSA + TAMPO SOFT CLOSE CLIP OFF 262 750,00 **299 535,00**

CF-A208 A2 BIDÉ SUSPENSO 228 750,00 **260 775,00**

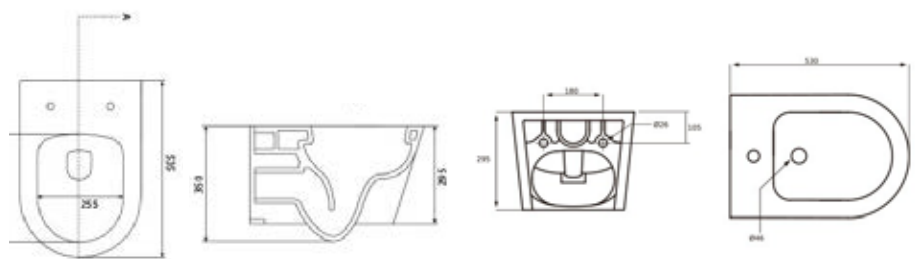



STYLE S BRANCO

CF-SS01 STYLE S PACK SANITA / SANITA + TANQUE + TAMPO SOFT CLOSE CLIP OFF 298 750,00 **340 575,00**

CF-SS08 STYLE S BIDÊ COMPACTO 148 750,00 **169 575,00**

CF-L015 A2 LAVATÓRIO POU SAR 450x330mm 86 750,00 **98 895,00**

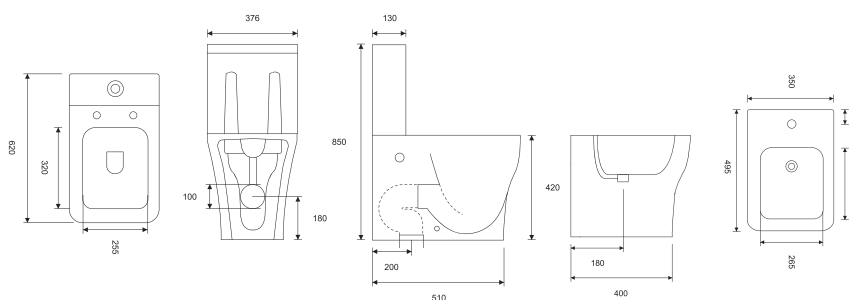

STYLE S SUSPENSO BRANCO

CF-SS02 STYLE S SUSPENSO / SANITA SUSPENSA + TAMPO SOFT CLOSE CLIP OFF 198 750,00 **226 575,00**

CF-SS07 STYLE S SUSPENSO / BIDÊ SUSPENSO 192 750,00 **219 735,00**

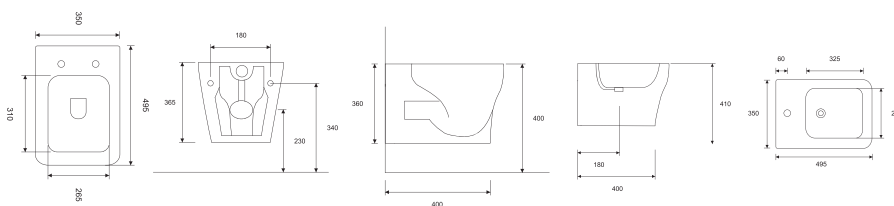



STYLE R BRANCO

CF-SR01	STYLE R PACK SANITA / SANITA + TANQUE + TAMPO SOFT CLOSE CLIP OFF	298 750,00	340 575,00
CF-SR08	STYLE R BIDÊ COMPACTO	156 750,00	178 695,00
CF-L017	A2R LAVATÓRIO POUSAR 415mm	84 750,00	96 615,00

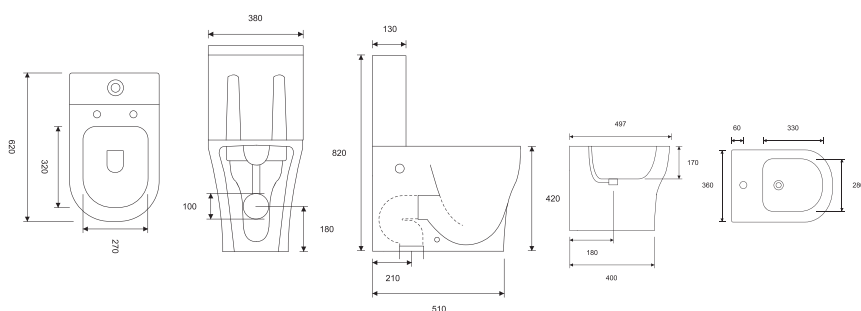

STYLE R SUSPENSO BRANCO

CF-SR02	STYLE R SUSPENSO / SANITA SUSPENSA + TAMPO SOFT CLOSE CLIP OFF	198 750,00	226 575,00
CF-SR07	STYLE R SUSPENSO / BIDÊ SUSPENSO	192 750,00	219 735,00

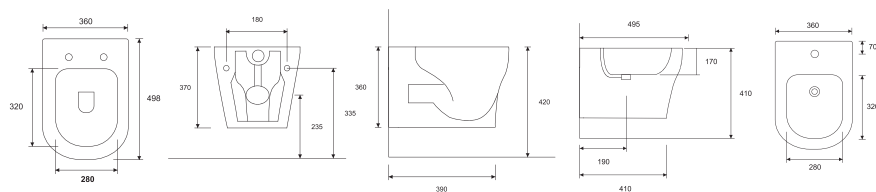



BOHEMIC BRANCO

RB-BH01

BOHEMIC PACK SANITA / SANITA + TANQUE
+ TAMPO SOFT CLOSE CLIP OFF

342 750,00

390 735,00

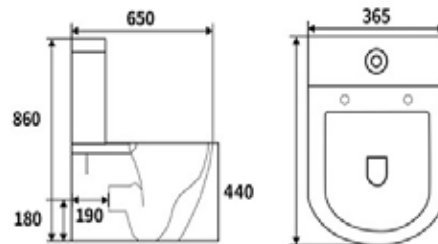

FLY BRANCO

RB-FY01

FLY PACK SANITA / SANITA + TANQUE +
TAMPO SOFT CLOSE CLIP OFF

328 750,00

374 775,00

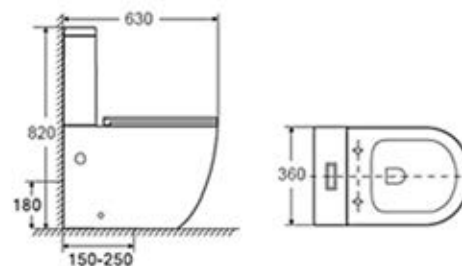



ROCK BRANCO

RB-RK01 ROCK PACK SANITA / SANITA + TANQUE + TAMPO SOFT CLOSE CLIP OFF 328 750,00 **374 775,00**

RB-RK05 ROCK BIDÉ COMPACTO 236 750,00 **269 895,00**

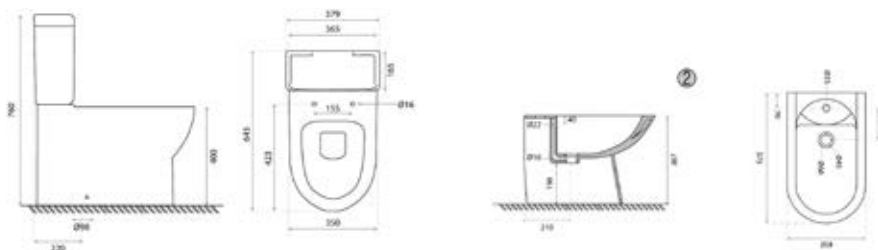

ULTRA BRANCO

RB-UT01 ULTRA PACK SANITA / SANITA + TANQUE + TAMPO SOFT CLOSE CLIP OFF 276 750,00 **315 495,00**

RB-UT05 ULTRA BIDÉ COMPACTO 220 750,00 **251 655,00**

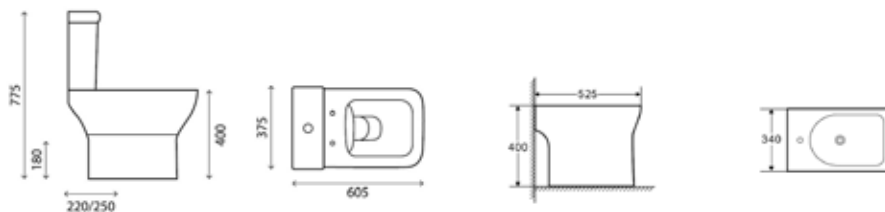



AQUARIO PLUS BRANCO

DAV-A010 AQUARIO PLUS PACK SANITA / SANITA + TANQUE + TAMPO SOFT CLOSE CLIP OFF 148 750,00 **169 575,00**

DAV-A014 AQUARIO PLUS BIDÉ COMPACTO 78 750,00 **89 775,00**

DAV-A015 AQUARIO PLUS LAVATÓRIO + COLUNA 55 CM 64 750,00 **73 815,00**

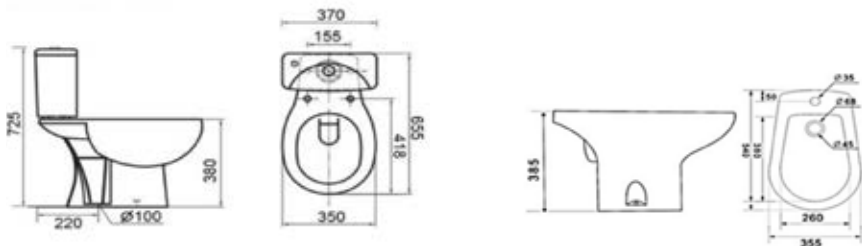

ORBITA BRANCO

BM-SN14 ORBITA PACK SANITA / SANITA + TANQUE + TAMPO SOFT CLOSE CLIP OFF 149 750,00 **170 715,00**

BM-SN15 ORBITA BIDÉ COMPACTO 124 750,00 **142 215,00**

BM-SN16 ORBITA LAVATÓRIO + COLUNA 55 CM 108 750,00 **123 975,00**

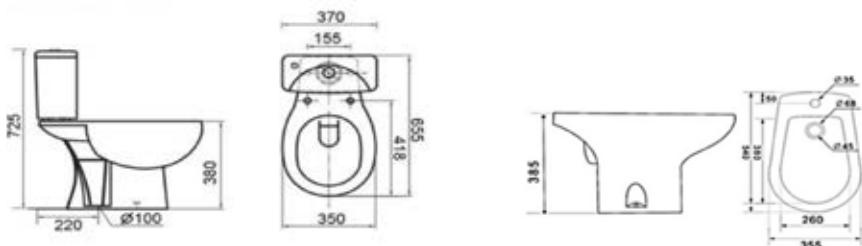

**NEXO INFANTIL**

ST-NX50	NEXO INFANTIL / SANITA+TAMPO AMARELO	256 750,00	292 695,00
ST-NX51	NEXO INFANTIL / SANITA+TAMPO AZUL	256 750,00	292 695,00
ST-NX52	NEXO INFANTIL / SANITA+TAMPO BRANCO	256 750,00	292 695,00
ST-NX53	NEXO INFANTIL / SANITA+TAMPO ROSA	256 750,00	292 695,00

**URINOL WCA**

SD-UR50	WCA - URINOL ENTRADA AGUA P/ TRÁS	228 950,00	261 003,00
----------------	-----------------------------------	------------	-------------------

**URINOL CUBIC**

SD-UR10	CUBIC - URINOL ENTRADA AGUA P/ CIMA	228 950,00	261 003,00
----------------	-------------------------------------	------------	-------------------

**URINOL JADE**

SD-UR20	JADE C/ TAMPA - URINOL ENTRADA AGUA P/ TRÁS	188 950,00	215 403,00
----------------	---	------------	-------------------

NOVIDADE

**URINOL ORBITA**

BM-SN17	ORBITA - URINOL ENTRADA AGUA P/ CIMA	77 500,00	88 350,00
----------------	--------------------------------------	-----------	------------------



AUTOCLISMO INTERIOR DAMA P/ SANITA SUSPENSA

SE-022

- Com estrutura para paredes de alvenaria, paredes ligeiras ou calha técnica
- Dupla descarga 3/6l; regulável 3/4,5l
- Isolamento anticondensação e acústico em EPS com alvéolos
- Torneira de boia silenciosa
- Profundidade 80 mm
- Suporta até 400 Kg
- Reservatório em polipropileno (PP) altamente resistente Temp. água máx. 25°C
- Marcação C E : EN 14055
- Eficiência energética: classe A
- Curva de esgoto ajustável em profundidade
- Altura regulável de 0-200 mm

284 750,00

324 615,00



AUTOCLISMO INTERIOR EASY P/ SANITA SUSPENSA

SE-020

- Com estrutura para paredes de alvenaria
- Dupla descarga 3/6l; regulável 3/4,5l
- Isolamento anticondensação e acústico em EPS com alvéolos
- Torneira de boia silenciosa
- Profundidade 80 mm
- Reservatório em polipropileno (PP) altamente resistente Temp. água máx. 25°C
- Marcação CE: EN14055
- Eficiência energética: classe A
- Curva de esgoto ajustável em profundidade

219 750,00

250 515,00



AUTOCLISMO INTERIOR SIMPLES

SE-024

- Com estrutura para paredes de alvenaria
- Dupla descarga 3/6l; regulável 3/4,5l
- Isolamento anticondensação e acústico em EPS com alvéolos
- Torneira de boia silenciosa
- Profundidade 80 mm
- Reservatório em polipropileno (PP) altamente resistente Temp. água máx. 25°C
- Marcação CE: EN14055
- Eficiência energética: classe A
- Curva de esgoto ajustável em profundidade

195 750,00

223 155,00



EXTRUTURA ENCASTRAR DAMA P/ BIDÉ SUSPENSO

SE-075

- Estrutura metálica para bidé
- Fixação à parede e ao chão
- Fácil instalação e manutenção
- Altura ajustável
- Suporta até 400 kg

117 750,00

134 235,00



AUTOCLISMO EXTERIOR IOCA / BASIC

SE-025

- Descarga interrompível (até 6 litros)
- Fácil regulação do volume de descarga máxima entre 6l e 9l
- Sistema de encaixe rápido do tubo de descarga
- Entrada de água lateral (esquerda/direita) e posterior
- Fácil instalação e manutenção
- Inclui todos os acessórios necessários para instalação
- Válvula de descarga com vedante em silicone
- Com tubo de descarga ø50 x ø40 x 325 mm

47 250,00

53 865,00

**PLACAS P/ AUTOCLISMO DAMA ABS**

SE-160	PLACA REDONDA DUPLA DESCARGA ABS BRANCO	37 750,00	43 035,00
SE-161	PLACA REDONDA DUPLA DESCARGA ABS CROMADO	37 750,00	43 035,00
SE-164	PLACA QUADRADA DUPLA DESCARGA ABS CROMADO	37 750,00	43 035,00

**PLACAS P/ AUTOCLISMO DAMA INOX**

SE-166	PLACA QUADRADA DUPLA DESCARGA INOX CROMADO	98 750,00	112 575,00
SE-167	PLACA QUADRADA DUPLA DESCARGA INOX PRETO	98 750,00	112 575,00
SE-168	PLACA QUADRADA DUPLA DESCARGA INOX DOURADO ESCOVADO	98 750,00	112 575,00

**PLACAS P/ AUTOCLISMO EASY ABS**

SE-163	PLACA REDONDA ROUND ABS PRETO	68 750,00	78 375,00
SE-163/B	PLACA REDONDA ROUND ABS BRONZE	168 950,00	192 603,00
SE-163/O	PLACA REDONDA ROUND ABS OURO	168 950,00	192 603,00
SE-165	PLACA QUADRADA KEEN ABS CROMADO	54 750,00	62 415,00

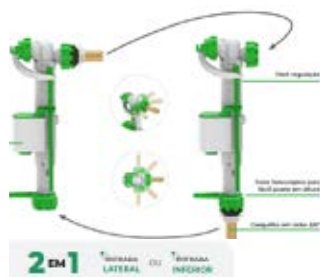
**BOIA COMBI**

SE-101	<ul style="list-style-type: none"> • Fácil ajuste em altura • Entrada lateral orientável a 180° • Enchimento rápido e silencioso • Excelente desempenho com qualquer pressão de rede • Sistema de entrada de água ultra-silencioso • Casquilho em latão • Fácil adaptação para torneira de boia de entrada de água lateral ou inferior 	30 950,00	35 283,00
---------------	---	-----------	------------------

**BOIA SIMPLEX**

SE-101-1	<ul style="list-style-type: none"> • Torneira boia de entrada de água inferior para autoclismos cerâmicos • Enchimento rápido e silencioso • Casquilho em latão • Fácil ajuste em altura 	19 950,00	22 743,00
-----------------	--	-----------	------------------

**VALVULA DE DESCARGA DUO**

SE-102	<ul style="list-style-type: none"> • Válvula de dupla descarga para autoclismos cerâmicos • Botão cromado • Fácil e rápida instalação e ajuste em altura • Descarga regulável • Posicionamento do botão ajustável para todo o tipo de cisternas • Inclui parafusos de fixação em aço inox para cisterna 	29 750,00	33 915,00
---------------	---	-----------	------------------

**SIFÃO URINOL GARRAFA**

SE-225	SIFÃO GARRAFA LATÃO / ZAMAC CROMADO	27 750,00	31 635,00
---------------	-------------------------------------	-----------	------------------



KIT CHUVEIROS HIGIENICOS

SD-253		KIT CHUVEIRO HIGIENICO 4 PÇAS	68 750,00	78 375,00
SD-253/P		KIT CHUVEIRO HIGIENICO 4 PÇAS	108 950,00	124 203,00
SD-253/O		KIT CHUVEIRO HIGIENICO 4 PÇAS	108 950,00	124 203,00



CHUVEIROS HIGIENICOS

SD-250		CHUVEIRO HIGIENICO ABS REDONDO	6 750,00	7 695,00
SD-250/P		CHUVEIRO HIGIENICO LATÃO REDONDO	25 750,00	29 355,00
SD-251		CHUVEIRO HIGIENICO LATÃO QUADRADO	25 750,00	29 355,00



SUPORTES C/ TOMADA

SD-513		SUPORTE CHUVEIRO REDONDO C/ TOMADA ÁGUA	24 750,00	28 215,00
SD-513/P		SUPORTE CHUVEIRO REDONDO C/ TOMADA ÁGUA	26 750,00	30 495,00
SD-511		SUPORTE CHUVEIRO QUADRADO C/ TOMADA ÁGUA	26 750,00	30 495,00



TORNEIRAS P/ CHUVEIROS HIGIENICOS

SD-604		TORNEIRA ESQUADRIA C/ SUPORTE CHUVEIRO	29 750,00	33 915,00
SD-603		TORNEIRA ESQUADRIA SAIDA DUPLA	26 750,00	30 495,00



BICHAS DE CHUVEIRO

SD-110		BICHA CHUVEIRO ARGOLAS 90-120 cm	5 750,00	6 555,00
SD-111		BICHA CHUVEIRO ARGOLAS 150-180 cm	6 750,00	7 695,00
SD-112/P		BICHA CHUVEIRO DUO 170 cm	18 750,00	21 375,00



TORNEIRAS ESQUADRIA

SD-605		TORNEIRA ESQUADRIA QUADRADA 1/2-3/8	12 750,00	14 535,00
SD-606		TORNEIRA ESQUADRIA QUADRADA 1/2-1/2	12 750,00	14 535,00



SD-608		TORNEIRA ESQUADRIA REDONDA 1/2-1/2	10 750,00	12 255,00
SD-607		TORNEIRA ESQUADRIA REDONDA 1/2-3/8	10 750,00	12 255,00
SD-607/P		TORNEIRA ESQUADRIA REDONDA 1/2-3/8	14 750,00	16 815,00
SD-607/O		TORNEIRA ESQUADRIA REDONDA 1/2-3/8	14 750,00	16 815,00



SD-600		TORNEIRA ESQUADRIA 1/2-3/8	5 950,00	6 783,00
SD-601		TORNEIRA ESQUADRIA 1/2-1/2	5 950,00	6 783,00
SD-602		TORNEIRA ESQUADRIA 1/2-3/4	5 950,00	6 783,00

BICHAS MALHA DE AÇO

SD-100	BICHA MALHA DE AÇO 3/8-3/8 F-F	3 750,00	4 275,00
SD-101	BICHA MALHA DE AÇO 1/2-3/8 F-F	3 750,00	4 275,00
SD-102	BICHA MALHA DE AÇO 1/2-1/2 F-F	3 750,00	4 275,00
SD-103	BICHA MALHA DE AÇO 1/2-3/8 M-F	3 750,00	4 275,00
SD-104	BICHA MALHA DE AÇO 1/2-1/2 M-F	3 750,00	4 275,00

**SIFÃO SANITA UNIVERSAL FLEXÍVEL**

SE-252	SIFÃO SANITA UNIVERSAL FLEXIVEL	16 950,00	19 323,00
SE-253	SIFÃO SANITA UNIVERSAL FLEXIVEL CURVO	16 950,00	19 323,00



SE-250	SIFÃO SANITA AO CHÃO / PVC	28 250,00	32 205,00
---------------	----------------------------	-----------	------------------



SE-251	SIFÃO SANITA A PAREDE / PVC	29 750,00	33 915,00
---------------	-----------------------------	-----------	------------------

**EXCENTRICO SANITA**

SE-080	EXCENTRICO SANITA PVC	3 500,00	3 990,00
---------------	-----------------------	----------	-----------------

**EMBOQUE SANITA**

SE-096	EMBOQUE SANITA INTERIOR / PVC	2 750,00	3 135,00
---------------	-------------------------------	----------	-----------------

**JUNTA VEDAÇÃO**

SE-095	JUNTA TANQUE SANITA	11 950,00	13 623,00
---------------	---------------------	-----------	------------------

**PARAFUSOS**

SE-151	PARAFUSOS SANITA HORIZONTAL 2 UND / INOX	2 950,00	3 363,00
---------------	--	----------	-----------------

SE-152	PARAFUSOS SANITA VERTICAL 2 UND / INOX	2 950,00	3 363,00
---------------	--	----------	-----------------



SE-153	PARAFUSOS SANITA - BIDÉ SUSPENSO / INOX	35 250,00	40 185,00
---------------	---	-----------	------------------



SE-154	PARAFUSOS TANQUE SANITA / INOX	13 750,00	15 675,00
---------------	--------------------------------	-----------	------------------



A woman with a colorful headband is seated in a wheelchair, looking out over a vast savanna landscape at sunset. The scene is bathed in warm, golden light, with acacia trees scattered across the plain and mountains in the distance. The woman's expression is contemplative as she gazes into the horizon.

dama

MOBILIDADE REDUZIDA



HANDICAP SANITA COMPACTA

SD-MR06	HANDICAP PACK SANITA + TANQUE + TAMPO	633 750,00	722 475,00
----------------	---------------------------------------	------------	-------------------

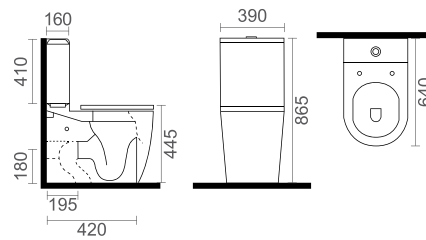

PROMOÇÃO

NEW WC CARE SUSPENSAS

SD-MR02	NEW WC CARE SANITA SUSPENSAS	498 750,00	568 575,00
----------------	------------------------------	------------	-------------------

SD-MR04	NEW WC CARE ARO SANITA S/TAMPO	98 950,00	112 803,00
----------------	--------------------------------	-----------	-------------------

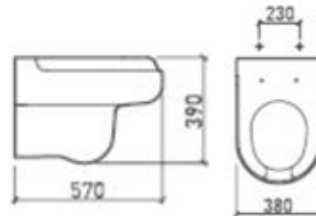

PROMOÇÃO

HANDICAP SANITA SUSPENSAS

SD-MR07	HANDICAP SANITA SUSPENSAS C/ TAMPO	368 750,00	420 375,00
----------------	------------------------------------	------------	-------------------

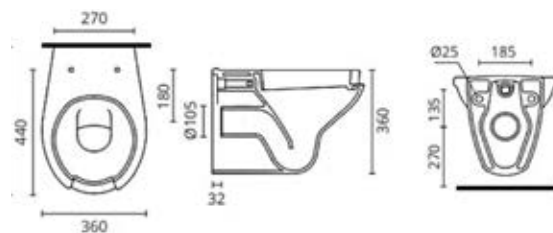

HANDICAP LAVATÓRIO PMR

SD-MR08	HANDICAP LAVATÓRIO PMR	292 750,00	333 735,00
----------------	------------------------	------------	-------------------

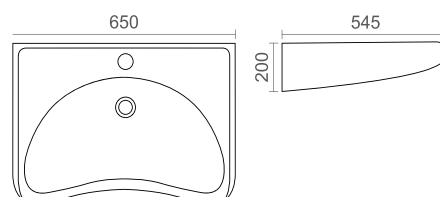

HANDICAP SUPORTE BASCULANTE



SD-MR62

HANDICAP SUPORTE BASCULANTE

568 750,00

648 375,00

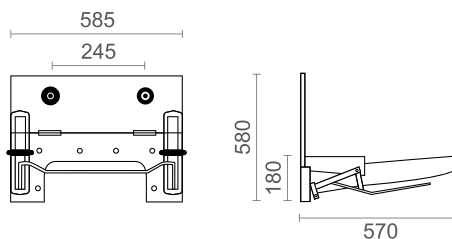

HANDICAP ESPELHO BASCULANTE 60X80

SD-MR51

HANDICAP ESPELHO BASCULANTE 60X80

387 750,00

442 035,00

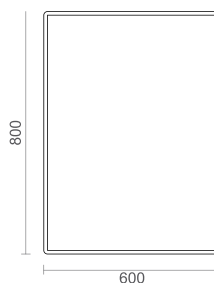

APOIO SIMPLES 30 / 60 CM

SD-MR13

APOIO SIMPLES INOX 30 cm

71 750,00

81 795,00

SD-MR14

APOIO SIMPLES INOX 60 cm

94 750,00

108 015,00

SD-MR14-1

APOIO SIMPLES LATÃO 60 cm

82 750,00

94 335,00



APOIO SIMPLES 90º

SD-MR16

APOIO SIMPLES INOX 90º

104 750,00

119 415,00

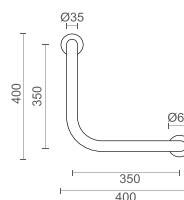

APOIO REBATIVEL 80 CM

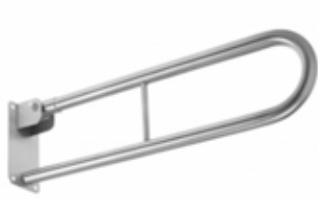

SD-MR11

APOIO REBATÍVEL 80CM

212 750,00

242 535,00

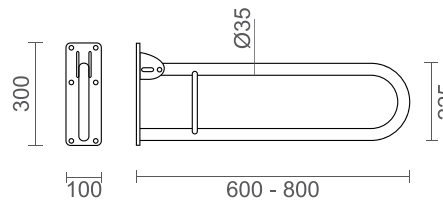

APOIO REBATIVEL C/ PORTA ROLOS 80 CM



SD-MR12

APOIO REBATÍVEL COM PORTA-ROLOS 80CM

212 750,00

242 535,00

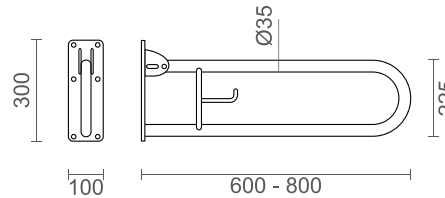

APOIO FIXO C/ 3 APOIOS 60 CM



SD-MR09

APOIO FIXO COM 3 APOIOS DIREITO

182 750,00

208 335,00

SD-MR09-1

APOIO FIXO COM 3 APOIOS ESQUERDO

182 750,00

208 335,00

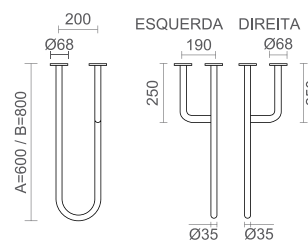

BANCO BASCULANTE INOX



SD-MR20

BANCO BASCULANTE EM INOX

382 750,00

436 335,00

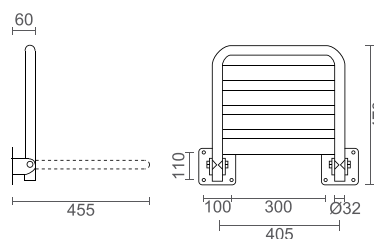

BANCO BASCULANTE ABS



SD-MR21

BANCO BASCULANTE ABS

114 750,00

130 815,00

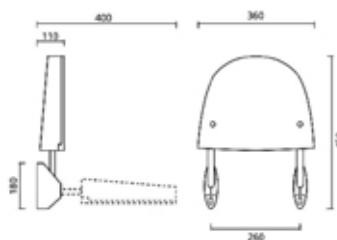

SAFE HOSPITALAR



BM-M080

SAFE MONOCOMANDO LAVATÓRIO HOPITALAR

85 750,00

97 755,00



BM-M081

SAFE MONOCOMANDO BASE C/ CHUVEIRO HOPITALAR

124 750,00

142 215,00

FRALDÁRIO



SD-MR55

FRALDÁRIO HORIZONTAL

780 750,00

890 055,00

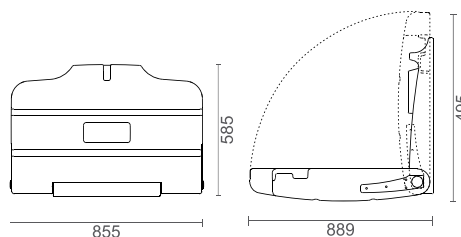

SD-MR56

FRALDÁRIO VERTICAL

780 750,00

890 055,00

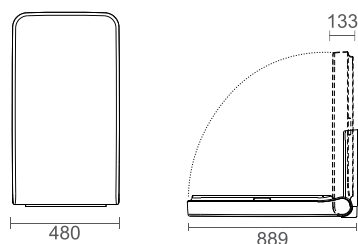





d!anna

BANHEIRAS E BASES



CHARME DE CANTO

ASD-BN210	CHARME CANTO / BANHEIRA SIMPLES 140x140	550 750,00	627 855,00
------------------	--	------------	-------------------

ASD-BN230	CHARME CANTO / BANHEIRA SIMPLES 150x150	662 750,00	755 535,00
------------------	--	------------	-------------------



CHARME

ASD-BN250	CHARME / BANHEIRA SIMPLES 160x70	204 750,00	233 415,00
------------------	----------------------------------	------------	-------------------

ASD-BN260	CHARME / BANHEIRA SIMPLES 170x70	212 750,00	242 535,00
------------------	----------------------------------	------------	-------------------

ASD-BN270	CHARME / BANHEIRA SIMPLES 180x80	240 750,00	274 455,00
------------------	----------------------------------	------------	-------------------

**PLANISSIMA DUO**

ASD-BN400	PLANISSIMA DUO / BANHEIRA SIMPLES 180x90	548 750,00	625 575,00
ASD-BN410	PLANISSIMA DUO / BANHEIRA SIMPLES 190x90	639 750,00	729 315,00
ASD-BN420	PLANISSIMA DUO / BANHEIRA SIMPLES 200x100	725 750,00	827 355,00

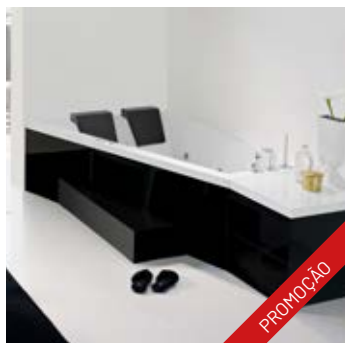
**PLANISSIMA CANTO**

ASD-BN350	PLANISSIMA CANTO / BANHEIRA SIMPLES 170x100x65 DIREITA	632 750,00	721 335,00
ASD-BN360	PLANISSIMA CANTO / BANHEIRA SIMPLES 170x100x65 ESQUERDA	632 750,00	721 335,00
ASD-BN370	PLANISSIMA DUO / BANHEIRA SIMPLES 170x120x65 DIREITA	652 750,00	744 135,00
ASD-BN380	PLANISSIMA DUO / BANHEIRA SIMPLES 170x120x65 ESQUERDA	652 750,00	744 135,00

**PLANISSIMA**

ASD-BN300	PLANISSIMA / BANHEIRA SIMPLES 150x70	248 750,00	283 575,00
ASD-BN310	PLANISSIMA / BANHEIRA SIMPLES 160x70	250 750,00	285 855,00
025.102	PLANISSIMA / BANHEIRA SIMPLES 160x75	262 750,00	299 535,00
ASD-BN320	PLANISSIMA / BANHEIRA SIMPLES 170x70	264 750,00	301 815,00



CLASSICA

ASD-BN100	CLASSICA / BANHEIRA SIMPLES 120x70	220 750,00	251 655,00
025.047	CLASSICA / BANHEIRA SIMPLES 135x70	220 750,00	251 655,00
ASD-BN101	CLASSICA / BANHEIRA SIMPLES 140x70	222 750,00	253 935,00
ASD-BN120	CLASSICA / BANHEIRA SIMPLES 160x70	232 750,00	265 335,00
ASD-BN130	CLASSICA / BANHEIRA SIMPLES 160x75	242 750,00	276 735,00
ASD-BN150	CLASSICA / BANHEIRA SIMPLES 170x75	249 750,00	284 715,00



VIANA

025.401	VIANA / BANHEIRA SIMPLES 180x80	98 950,00	112 803,00
----------------	---------------------------------	-----------	-------------------

SISTEMAS HIDROMASSAGEM

Jatos de água laterais

Lateral water jets



Jatos de ar inferiores



Bottom air jets



**ECOLINE**

- 6 injetores de água laterais orientáveis em ABS;
- Comando pneumático de 2 funções: on/off, massagem de água e regulação manual de caudal (mistura de ar);
- Crivo de sucção ABS;
- Motor 650w IP54 230-240-V 3A;
- Válvula de descarga automática;
- Ligação equipotencial;
- 2 anos de garantia contra defeitos de fabrico.
- Disponível em cromado.



CHARME CANTO 140-150

ASD-H12-A	PNEUMÁTICO SIMPLES ABS / 6 JATOS + 5 MICROS JATOS		1 312 750,00	1 496 535,00
ASD-H14-A	PNEUMÁTICO DUPLO ABS / 6 JATOS + 10 INJECTORES DE AR		1 788 750,00	2 039 175,00
ASD-H16-A	ELECTRÓNICO DUPLO ABS / 6 JATOS + 5 MICRO JATOS DE ÁGUA + 10 INJECTORES DE AR		2 348 750,00	2 677 575,00

**PNEUMÁTICO SIMPLES**

- 6 injetores de água laterais orientáveis em ABS;
- Comando pneumático de 2 funções: on/ off, massagem de água e regulação manual de caudal (mistura de ar);
- Crivo de sucção ABS;
- Motor 650w IP54 230-240-V 3A;
- Válvula de descarga automática;
- Quadro controlo pneumático com sensor nível de água;
- Ligação equipotencial;
- Interruptor diferencial monofásico proteção 25A/30mA - 240V - 50Hz;
- 2 anos de garantia contra defeitos de fabrico.
- Disponível em cromado.



PLANISSIMA DUO 200

ASD-H12-C	PNEUMÁTICO SIMPLES ABS / 6 JATOS + 6 MICROS JATOS		1 644 750,00	1 875 015,00
ASD-H14-C	PNEUMÁTICO DUPLO ABS / 6 JATOS + 10 INJECTORES DE AR		2 382 750,00	2 716 335,00
ASD-H16-C	ELECTRÓNICO DUPLO ABS / 6 JATOS + 6 MICRO JATOS DE ÁGUA + 10 INJECTORES DE AR		2 708 750,00	3 087 975,00

**PNEUMÁTICO DUPLO**

- 6 injetores de água laterais orientáveis em ABS;
- 10 injetores de ar em ABS;
- Comando pneumático 2 funções: on/off massagem de água e regulação manual de caudal (mistura de ar);
- Comando pneumático on/off massagem de ar;
- Crivo de sucção ABS;
- Motor 650w IP54 230-240-V 3A/ 800W IP54 230-240-V 3A (com micros);
- Compressor 830W IPX5 230-240-V 4,2A com aquecimento;
- Válvula de descarga automática com dreno;
- Quadro controlo pneumático com sensor nível de água;
- Ligação equipotencial;
- Interruptor diferencial monofásico proteção 25A/30mA - 240V - 50Hz;
- 2 anos de garantia contra defeitos de fabrico. • Disponível em cromado.





PLANISSIMA DUO 180-190

ASD-H12-B	PNEUMÁTICO SIMPLES ABS / 6 JATOS + 6 MICROS JATOS		1 332 750,00	1 519 335,00
ASD-H14-B	PNEUMÁTICO DUPLO ABS / 6 JATOS + 10 INJECTORES DE AR		2 032 750,00	2 317 335,00
ASD-H16-B	ELECTRÓNICO DUPLO ABS / 6 JATOS + 6 MICRO JATOS DE ÁGUA + 10 INJECTORES DE AR		2 372 750,00	2 704 935,00

**ELETRÓNICO DUPLO**

- 6 injetores de água laterais orientáveis em ABS;
- 10 injetores de ar em ABS;
- Comando eletrónico de 4 funções: on/off massagem de água e ar, seleção +/- intensidade massa- gem de água e ar, intermitência automática da massagem de água, variação automática de intensidade da massagem de ar;
- Regulador manual de caudal (mistura de ar); Crivo de sucção ABS;
- Motor 650W IP54 230-240-V 3A ou 800W IP54 230-240-V 3A (com micros);
- Compressor 830W IPX 230-240-V 4,2A com aquecimento;
- Válvula de descarga automática com dreno;
- Quadro controlo eletrónico KOLLER SYSTEM;
- Sensor nível de água eletrónico; Ligação equipotencial;
- Interruptor diferencial monofásico proteção 24A/30mA - 240V - 50 Hz;
- 2 anos de garantia contra defeitos de fabrico. Disponível em cromado.

CHARME / CLASSICA / PLANISSIMA 150-160-170-180

ASD-H10	ECOLINE SIMPLES ABS / 6 JATOS		838 750,00	956 175,00
ASD-H12	PNEUMÁTICO SIMPLES ABS / 6 JATOS + 5 MICROS JATOS		1 182 750,00	1 348 335,00
ASD-H14	PNEUMÁTICO DUPLO ABS / 6 JATOS + 10 INJECTORES DE AR		1 662 750,00	1 895 535,00
ASD-H16	ELECTRÓNICO DUPLO ABS / 6 JATOS + 5 MICRO JATOS DE ÁGUA + 10 INJECTORES DE AR		2 226 750,00	2 538 495,00



CLASSICA

ASD-PN11	CHARME CANTO: PAINEL FRONTAL 140x50	298 750,00	340 575,00
ASD-PN13	CHARME CANTO: PAINEL FRONTAL 150x50	332 750,00	379 335,00



PAINEL FRONTAL ACRILICO

ASD-PN20	PAINEL FRONTAL: ACRILICO 120x50	104 750,00	119 415,00
ASD-PN21	PAINEL FRONTAL: ACRILICO 140x50	111 750,00	127 395,00
ASD-PN22	PAINEL FRONTAL: ACRILICO 150x50	117 750,00	134 235,00
ASD-PN23	PAINEL FRONTAL: ACRILICO 160x50	124 750,00	142 215,00
ASD-PN24	PAINEL FRONTAL: ACRILICO 170x50	126 750,00	144 495,00
ASD-PN25	PAINEL FRONTAL: ACRILICO 180x50	142 750,00	162 735,00
ASD-PN26	PAINEL FRONTAL: ACRILICO 190x50	172 750,00	196 935,00
ASD-PN27	PAINEL FRONTAL: ACRILICO 200x50	184 750,00	210 615,00



PAINEL LATERAL ACRILICO DIREITO

ASD-PN31	PAINEL LATERAL: ACRILICO 70x50 Direito	73 750,00	84 075,00
ASD-PN32	PAINEL LATERAL: ACRILICO 75x50 Direito	76 750,00	87 495,00
ASD-PN33	PAINEL LATERAL: ACRILICO 80x50 Direito	96 750,00	110 295,00
ASD-PN34	PAINEL LATERAL: ACRILICO 90x50 Direito	99 750,00	113 715,00
ASD-PN35	PAINEL LATERAL: ACRILICO 100x50 Direito	105 750,00	120 555,00



PAINEL LATERAL ACRILICO ESQUERDO

ASD-PN41	PAINEL LATERAL: ACRILICO 70x50 Esquerdo	73 750,00	84 075,00
ASD-PN42	PAINEL LATERAL: ACRILICO 75x50 Esquerdo	76 750,00	87 495,00
ASD-PN43	PAINEL LATERAL: ACRILICO 80x50 Esquerdo	96 750,00	110 295,00
ASD-PN44	PAINEL LATERAL: ACRILICO 90x50 Esquerdo	99 750,00	113 715,00
ASD-PN45	PAINEL LATERAL: ACRILICO 100x50 Esquerdo	105 750,00	120 555,00



PAINEL FONTAL FENOLICO WENGUE

ASD-P53	PAINEL FRONTAL: FENOLICO WENGUE 160x50	342 750,00	390 735,00
ASD-P54	PAINEL FRONTAL: FENOLICO WENGUE 170x50	361 750,00	412 395,00
ASD-P55	PAINEL FRONTAL: FENOLICO WENGUE 180x50	364 750,00	415 815,00
ASD-P56	PAINEL FRONTAL: FENOLICO WENGUE 190x50	368 750,00	420 375,00
ASD-P57	PAINEL FRONTAL: FENOLICO WENGUE 200x50	375 750,00	428 355,00



PAINEL LATERAL ACRILICO ESQUERDO

ASD-PN61	PAINEL LATERAL: FENOLICO WENGUE 70x50	184 750,00	210 615,00
ASD-PN62	PAINEL LATERAL: FENOLICO WENGUE 75x50	188 950,00	215 403,00
ASD-PN63	PAINEL LATERAL: FENOLICO WENGUE 80x50	193 750,00	220 875,00
ASD-PN64	PAINEL LATERAL: FENOLICO WENGUE 90x50	202 750,00	231 135,00
ASD-PN65	PAINEL LATERAL: FENOLICO WENGUE 100x50	206 750,00	235 695,00



SOUL WHITE 170X75

RB-BN81

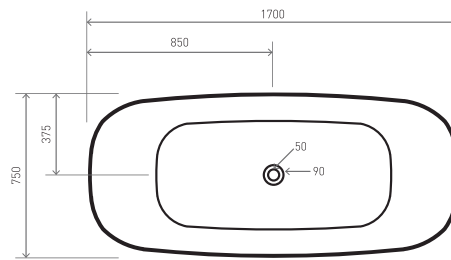

2 475 750,00

2 822 355,00



SOUL BLACK & WHITE 170X75

RB-BN80

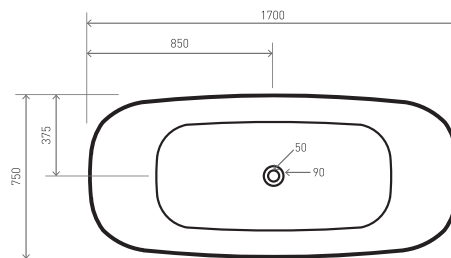

2 575 750,00

2 936 355,00



PACIFIC LED 170X75

RB-BN60

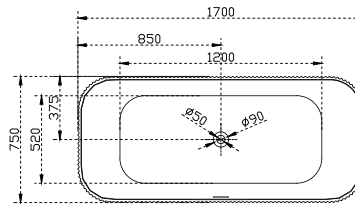

3 175 750,00

3 620 355,00



CHIC BRANCO / CINZA

DAV-BN20

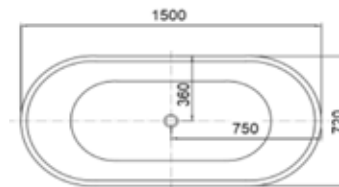

1 975 750,00

2 252 355,00



SUBLIME WHITE 170X80

RB-BN70

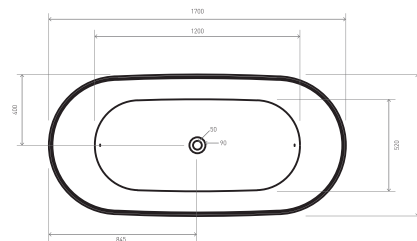

2 475 750,00

2 822 355,00



ETERNAL BRANCO BRILHO / MATE 170X78

DAV-BN60

BRILHO

1 675 750,00

1 910 355,00

DAV-BN61

MATE

1 975 750,00

2 252 355,00

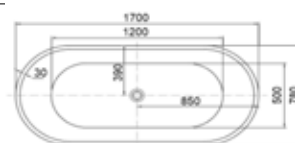



ESTELA BLACK & WHITE 176X80

DAV-BN41

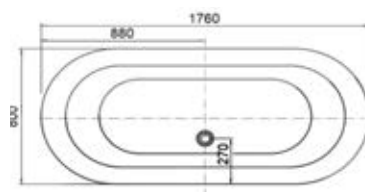

1 475 750,00

1 682 355,00



ESTELA WHITE 176X80

DAV-BN40

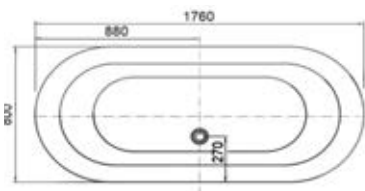

1 475 750,00

1 682 355,00



CHARMING GOLD 175X71

RB-BN30



2 762 750,00

3 149 535,00

RB-BN31



2 762 750,00

3 149 535,00

RB-BN32



2 762 750,00

3 149 535,00

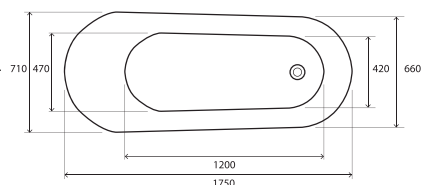

ÉPOCA 155X70

DAV-BN50



1 625 750,00

1 853 355,00

DAV-BN51



1 625 750,00

1 853 355,00

DAV-BN52



1 625 750,00

1 853 355,00

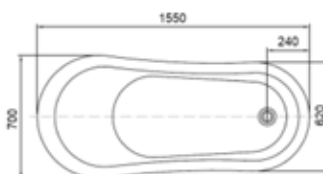



As bases de duche são revestidas o GEL COAT caracterizado por:

- Zero absorção de água.
- Dureza de 45 no escala de Barcol.
- Alto resistêncio a riscos.
- Anti-bacteriológico.
- Anti-derrapante.
- Resistente o altas temperaturas.
- Resistente a agentes químicos.
- Personalizável de acordo com as necessidades do cliente.
- Espessura de approxi. 3 cm.

MINERAL BASE CHUVEIRO PEDRA

RB-BS100	MINERAL BRANCO: BASE CHUVEIRO PEDRA NATURAL C/ VÁLVULA	80x80	226 750,00	258 495,00
RB-BS101	MINERAL BRANCO: BASE CHUVEIRO PEDRA NATURAL C/ VÁLVULA	90x90	286 750,00	326 895,00
RB-BS102	MINERAL BRANCO: BASE CHUVEIRO PEDRA NATURAL C/ VÁLVULA	100x80	282 750,00	322 335,00
RB-BS103	MINERAL BRANCO: BASE CHUVEIRO PEDRA NATURAL C/ VÁLVULA	110x80	310 750,00	354 255,00
RB-BS104	MINERAL BRANCO: BASE CHUVEIRO PEDRA NATURAL C/ VÁLVULA	120x80	339 750,00	387 315,00
RB-BS105	MINERAL BRANCO: BASE CHUVEIRO PEDRA NATURAL C/ VÁLVULA	130x80	367 250,00	418 665,00
RB-BS106	MINERAL BRANCO: BASE CHUVEIRO PEDRA NATURAL C/ VÁLVULA	140x80	396 750,00	452 295,00
RB-BS107	MINERAL BRANCO: BASE CHUVEIRO PEDRA NATURAL C/ VÁLVULA	150x80	424 750,00	484 215,00
RB-BS108	MINERAL BRANCO: BASE CHUVEIRO PEDRA NATURAL C/ VÁLVULA	160x80	453 750,00	517 275,00
RB-BS109	MINERAL BRANCO: BASE CHUVEIRO PEDRA NATURAL C/ VÁLVULA	170x80	481 750,00	549 195,00
RB-BS110	MINERAL BRANCO: BASE CHUVEIRO PEDRA NATURAL C/ VÁLVULA	180x80	508 750,00	579 975,00
RB-BS111	MINERAL BRANCO: BASE CHUVEIRO PEDRA NATURAL C/ VÁLVULA	190x80	538 750,00	614 175,00
RB-BS112	MINERAL BRANCO: BASE CHUVEIRO PEDRA NATURAL C/ VÁLVULA	200x80	566 750,00	646 095,00



RB-BS100/P	MINERAL PRETO: BASE CHUVEIRO PEDRA NATURAL C/ VÁLVULA	80x80	226 750,00	258 495,00
RB-BS101/P	MINERAL PRETO: BASE CHUVEIRO PEDRA NATURAL C/ VÁLVULA	90x90	286 750,00	326 895,00
RB-BS102/P	MINERAL PRETO: BASE CHUVEIRO PEDRA NATURAL C/ VÁLVULA	100x80	282 750,00	322 335,00
RB-BS103/P	MINERAL PRETO: BASE CHUVEIRO PEDRA NATURAL C/ VÁLVULA	110x80	310 750,00	354 255,00
RB-BS104/P	MINERAL PRETO: BASE CHUVEIRO PEDRA NATURAL C/ VÁLVULA	120x80	339 750,00	387 315,00
RB-BS105/P	MINERAL PRETO: BASE CHUVEIRO PEDRA NATURAL C/ VÁLVULA	130x80	367 250,00	418 665,00
RB-BS106/P	MINERAL PRETO: BASE CHUVEIRO PEDRA NATURAL C/ VÁLVULA	140x80	396 750,00	452 295,00
RB-BS107/P	MINERAL PRETO: BASE CHUVEIRO PEDRA NATURAL C/ VÁLVULA	150x80	424 750,00	484 215,00
RB-BS108/P	MINERAL PRETO: BASE CHUVEIRO PEDRA NATURAL C/ VÁLVULA	160x80	453 750,00	517 275,00
RB-BS109/P	MINERAL PRETO: BASE CHUVEIRO PEDRA NATURAL C/ VÁLVULA	170x80	481 750,00	549 195,00
RB-BS110/P	MINERAL PRETO: BASE CHUVEIRO PEDRA NATURAL C/ VÁLVULA	180x80	508 750,00	579 975,00
RB-BS111/P	MINERAL PRETO: BASE CHUVEIRO PEDRA NATURAL C/ VÁLVULA	190x80	538 750,00	614 175,00
RB-BS112/P	MINERAL PRETO: BASE CHUVEIRO PEDRA NATURAL C/ VÁLVULA	200x80	566 750,00	646 095,00



STONE LUX BRANCA / PRETA



As bases STONELUX representam um novo conceito que permite personalizar o seu duche, oferecendo 2 cores e uma variedade de medidas, podendo adaptar o comprimento às suas necessidades.

As bases STONELUX permitem dois tipos de instalação, pousar ou instalar ao nível do pavimento. A tampa do escoador à cor da base possibilita um acabamento simples e moderno

As bases STONELUX são fabricadas em SMC (Sheet moulding compound). SMC é uma mistura constituída essencialmente por resina (UP), fibra de vidro e minerais, submetidos a um processo de moldagem por compressão.

DAV-BS10	STONE LUX BRANCO: BASE CHUVEIRO C/ VÁLVULA	80x80	203 750,00	232 275,00
DAV-BS10-1	STONE LUX BRANCO: BASE CHUVEIRO C/ VÁLVULA	90x90	243 750,00	277 875,00
DAV-BS11	STONE LUX BRANCO: BASE CHUVEIRO C/ VÁLVULA	100x80	243 750,00	277 875,00
DAV-BS12	STONE LUX BRANCO: BASE CHUVEIRO C/ VÁLVULA	120x80	276 750,00	315 495,00
DAV-BS13	STONE LUX BRANCO: BASE CHUVEIRO C/ VÁLVULA	140x80	325 750,00	371 355,00
DAV-BS13-1	STONE LUX BRANCO: BASE CHUVEIRO C/ VÁLVULA	150x80	357 750,00	407 835,00
DAV-BS14	STONE LUX BRANCO: BASE CHUVEIRO C/ VÁLVULA	160x80	373 750,00	426 075,00
DAV-BS14-1	STONE LUX BRANCO: BASE CHUVEIRO C/ VÁLVULA	170x80	390 750,00	445 455,00
DAV-BS15	STONE LUX BRANCO: BASE CHUVEIRO C/ VÁLVULA	180x80	406 750,00	463 695,00
DAV-BS16	STONE LUX BRANCO: BASE CHUVEIRO C/ VÁLVULA	200x80	471 750,00	537 795,00



DAV-BS20	STONE LUX PRETO: BASE CHUVEIRO C/ VÁLVULA	80x80	203 750,00	232 275,00
DAV-BS20-1	STONE LUX PRETO: BASE CHUVEIRO C/ VÁLVULA	90x90	243 750,00	277 875,00
DAV-BS21	STONE LUX PRETO: BASE CHUVEIRO C/ VÁLVULA	100x80	243 750,00	277 875,00
DAV-BS22	STONE LUX PRETO: BASE CHUVEIRO C/ VÁLVULA	120x80	276 750,00	315 495,00
DAV-BS23	STONE LUX PRETO: BASE CHUVEIRO C/ VÁLVULA	140x80	325 750,00	371 355,00
DAV-BS23-1	STONE LUX PRETO: BASE CHUVEIRO C/ VÁLVULA	150x80	357 750,00	407 835,00
DAV-BS24	STONE LUX PRETO: BASE CHUVEIRO C/ VÁLVULA	160x80	373 750,00	426 075,00
DAV-BS24-1	STONE LUX PRETO: BASE CHUVEIRO C/ VÁLVULA	170x80	390 750,00	445 455,00
DAV-BS25	STONE LUX PRETO: BASE CHUVEIRO C/ VÁLVULA	180x80	406 750,00	463 695,00
DAV-BS26	STONE LUX PRETO: BASE CHUVEIRO C/ VÁLVULA	200x80	471 750,00	537 795,00



PLANISSIMA CANTO

ASD-BS200	BASE CHUVEIRO ACRÍLICA DE CANTO C/ VÁLVULA	75x75	178 750,00	203 775,00
ASD-BS201	BASE CHUVEIRO ACRÍLICA DE CANTO C/ VÁLVULA	80x80	182 750,00	208 335,00
ASD-BS202	BASE CHUVEIRO ACRÍLICA DE CANTO C/ VÁLVULA	90x90	209 750,00	239 115,00
ASD-BS203	BASE CHUVEIRO ACRÍLICA DE CANTO C/ VÁLVULA	100x100	250 750,00	285 855,00



PLANISSIMA QUADRADA

ASD-BS210	BASE CHUVEIRO ACRÍLICA QUADRADA C/ VÁLVULA	70x70	159 750,00	182 115,00
ASD-BS211	BASE CHUVEIRO ACRÍLICA QUADRADA C/ VÁLVULA	75x75	168 750,00	192 375,00
ASD-BS212	BASE CHUVEIRO ACRÍLICA QUADRADA C/ VÁLVULA	80x80	182 750,00	208 335,00
ASD-BS213	BASE CHUVEIRO ACRÍLICA QUADRADA C/ VÁLVULA	90x90	209 750,00	239 115,00
ASD-BS214	BASE CHUVEIRO ACRÍLICA QUADRADA C/ VÁLVULA	100x100	250 750,00	285 855,00



PLANISSIMA RECTANGULAR

ASD-BS220	BASE CHUVEIRO ACRÍLICA RECT. C/ VÁLVULA	90x75	248 750,00	283 575,00
ASD-BS221	BASE CHUVEIRO ACRÍLICA RECT. C/ VÁLVULA	90x80	257 750,00	293 835,00
ASD-BS222	BASE CHUVEIRO ACRÍLICA RECT. C/ VÁLVULA	100x75	267 750,00	305 235,00
ASD-BS223	BASE CHUVEIRO ACRÍLICA RECT. C/ VÁLVULA	100x80	285 750,00	325 755,00
020.361	BASE CHUVEIRO ACRÍLICA RECT. C/ VÁLVULA	100x90	310 750,00	354 255,00
020.362	BASE CHUVEIRO ACRÍLICA RECT. C/ VÁLVULA	110x70	275 750,00	314 355,00
ASD-BS224	BASE CHUVEIRO ACRÍLICA RECT. C/ VÁLVULA	110x75	283 750,00	323 475,00
ASD-BS225	BASE CHUVEIRO ACRÍLICA RECT. C/ VÁLVULA	110x80	299 750,00	341 715,00
ASD-BS227	BASE CHUVEIRO ACRÍLICA RECT. C/ VÁLVULA	120x80	311 750,00	355 395,00
ASD-BS229	BASE CHUVEIRO ACRÍLICA RECT. C/ VÁLVULA	130x80	332 750,00	379 335,00
020.373	BASE CHUVEIRO ACRÍLICA RECT. C/ VÁLVULA	130x90	345 750,00	394 155,00
ASD-BS231	BASE CHUVEIRO ACRÍLICA RECT. C/ VÁLVULA	140x80	351 750,00	400 995,00
ASD-BS232	BASE CHUVEIRO ACRÍLICA RECT. C/ VÁLVULA	150x75	366 750,00	418 095,00
ASD-BS233	BASE CHUVEIRO ACRÍLICA RECT. C/ VÁLVULA	150x80	389 750,00	444 315,00
ASD.-BS234	BASE CHUVEIRO ACRÍLICA RECT. C/ VÁLVULA	160x75	409 750,00	467 115,00
ASD-BS235	BASE CHUVEIRO ACRÍLICA RECT. C/ VÁLVULA	160x80	444 750,00	507 015,00
ASD-BS236	BASE CHUVEIRO ACRÍLICA RECT. C/ VÁLVULA	170x75	466 750,00	532 095,00
ASD-BS237	BASE CHUVEIRO ACRÍLICA RECT. C/ VÁLVULA	170x80	503 750,00	574 275,00
020.389	BASE CHUVEIRO ACRÍLICA RECT. C/ VÁLVULA	170x90	513 750,00	585 675,00
ASD-BS238	BASE CHUVEIRO ACRÍLICA RECT. C/ VÁLVULA	180x80	529 750,00	603 915,00
ASD-BS239	BASE CHUVEIRO ACRÍLICA RECT. C/ VÁLVULA	180x90	555 750,00	633 555,00
ASD-BS240	BASE CHUVEIRO ACRÍLICA RECT. C/ VÁLVULA	190x80	595 750,00	679 155,00
ASD-BS241	BASE CHUVEIRO ACRÍLICA RECT. C/ VÁLVULA	190x90	621 750,00	708 795,00
ASD-BS242	BASE CHUVEIRO ACRÍLICA RECT. C/ VÁLVULA	200x80	703 750,00	802 275,00

**CLÁSSICA CANTO**

ASD-BS100	BASE CHUVEIRO CANTO	80x80	138 950,00	158 403,00
020.030	BASE CHUVEIRO CANTO	85x85	163 950,00	186 903,00
ASD-BS101	BASE CHUVEIRO CANTO	90x90	170 950,00	194 883,00

**CLÁSSICA QUADRADA**

ASD-BS110	BASE CHUVEIRO ACRÍLICA QUADRADA	70x70	121 750,00	138 795,00
ASD-BS111	BASE CHUVEIRO ACRÍLICA QUADRADA	75x75	149 750,00	170 715,00
ASD-BS112	BASE CHUVEIRO ACRÍLICA QUADRADA	80x80	142 750,00	162 735,00
ASD-BS113	BASE CHUVEIRO ACRÍLICA QUADRADA	90x90	172 750,00	196 935,00

**CLÁSSICA RECTANGULAR**

ASD-BS120	BASE CHUVEIRO ACRÍLICA RECTANGULAR	90x75	172 750,00	196 935,00
020.016	BASE CHUVEIRO ACRÍLICA RECTANGULAR	100x70	191 750,00	218 595,00
020.017	BASE CHUVEIRO ACRÍLICA RECTANGULAR	100x75	196 750,00	224 295,00
ASD-BS121	BASE CHUVEIRO ACRÍLICA RECTANGULAR	100x80	198 750,00	226 575,00
020.020	BASE CHUVEIRO ACRÍLICA RECTANGULAR	120x75	222 750,00	253 935,00
ASD-BS122	BASE CHUVEIRO ACRÍLICA RECTANGULAR	120x80	225 750,00	257 355,00
ASD-BS125	BASE CHUVEIRO ACRÍLICA RECTANGULAR	150x80	293 750,00	334 875,00

**EXTRAPLANA CANTO**

020.042	BASE CHUVEIRO ACRÍLICA CANTO	100x100	158 750,00	180 975,00
----------------	------------------------------	---------	------------	-------------------

**EXTRAPLANA RECTANGULAR**

020.045	BASE CHUVEIRO ACRÍLICA RECTANGULAR	100x75	158 750,00	180 975,00
020.046	BASE CHUVEIRO ACRÍLICA RECTANGULAR	100x90	168 750,00	192 375,00
020.047	BASE CHUVEIRO ACRÍLICA RECTANGULAR	110x70	158 750,00	180 975,00
020.049	BASE CHUVEIRO ACRÍLICA RECTANGULAR	110x80	168 750,00	192 375,00

**OPEN EXTRAPLANA**

020.180	BASE CHUVEIRO ACRÍLICA RECTANGULAR	100x70	154 750,00	176 415,00
020.190	BASE CHUVEIRO ACRÍLICA RECTANGULAR	100x75	158 750,00	180 975,00
020.200	BASE CHUVEIRO ACRÍLICA RECTANGULAR	100x80	160 750,00	183 255,00
020.210	BASE CHUVEIRO ACRÍLICA RECTANGULAR	120x70	168 750,00	192 375,00
020.240	BASE CHUVEIRO ACRÍLICA RECTANGULAR	140x80	176 750,00	201 495,00



STRADO RECTANGULAR

020.500	BASE CHUVEIRO ACRÍLICA RECTANGULAR	100x80	160 750,00	183 255,00
020.520	BASE CHUVEIRO ACRÍLICA RECTANGULAR	170x80	188 750,00	215 175,00



STEPIN QUADRADA

020.542	BASE CHUVEIRO ACRÍLICA QUADRADA	80x80	128 750,00	146 775,00
----------------	---------------------------------	-------	------------	-------------------



FACE QUADRADA

020.094	BASE CHUVEIRO ACRÍLICA QUADRADA	100x80	160 750,00	183 255,00
020.095	BASE CHUVEIRO ACRÍLICA QUADRADA	170x80	188 750,00	215 175,00

BASES DE CHUVEIRO CERAMICAS



AGUA QUADRADA

020.010	BASE CHUVEIRO CERAMICA QUADRADA	90x90	128 750,00	146 775,00
----------------	---------------------------------	-------	------------	-------------------



MORAIRA QUADRADA

020.141	BASE CHUVEIRO CERAMICA QUADRADA	70x70	98 750,00	112 575,00
020.150	BASE CHUVEIRO CERAMICA QUADRADA	90x90	128 750,00	146 775,00



WCA RECTANGULAR

020.574	BASE CHUVEIRO CERAMICA RECTANGULAR	90x80	128 750,00	146 775,00
----------------	------------------------------------	-------	------------	-------------------



TIME RECTANGULAR

020.550	BASE CHUVEIRO CERAMICA RECTANGULAR	100x80	128 750,00	146 775,00
020.555	BASE CHUVEIRO CERAMICA RECTANGULAR	120x80	148 750,00	169 575,00

WATERLINE RECTANGULAR



020.576	BASE CHUVEIRO CERAMICA RECTANGULAR	120x70	128 750,00	146 775,00
----------------	------------------------------------	--------	------------	-------------------



EXTRA LARGE RECTANGULAR

020.060	BASE CHUVEIRO CERAMICA RECTANGULAR	120x70	128 750,00	146 775,00
----------------	------------------------------------	--------	------------	-------------------

BASES DE CHUVEIRO PEDRA

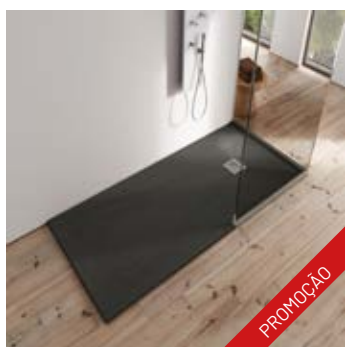

PLANESTONE RECTANGULAR ANTRACITE

ASD-BS314	BASE CHUVEIRO PEDRA RECTANGULAR	130x80	367 250,00	418 665,00
------------------	---------------------------------	--------	------------	-------------------

ASD-BS316	BASE CHUVEIRO PEDRA RECTANGULAR	150x80	424 750,00	484 215,00
------------------	---------------------------------	--------	------------	-------------------

ASD-BS317	BASE CHUVEIRO PEDRA RECTANGULAR	160x80	444 750,00	507 015,00
------------------	---------------------------------	--------	------------	-------------------

ASD-BS318	BASE CHUVEIRO PEDRA RECTANGULAR	180x80	508 750,00	579 975,00
------------------	---------------------------------	--------	------------	-------------------

CABINES DE HIDROMASSAGEM



INOVA QUADRADA

065.040	CABINE DE DUCHE QUADRADA	80x80	1 825 750,00	2 081 355,00
----------------	--------------------------	-------	--------------	---------------------

065.041	CABINE DE DUCHE QUADRADA	90x90	1 925 750,00	2 195 355,00
----------------	--------------------------	-------	--------------	---------------------

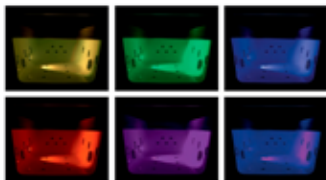

CROMOTERAPIA 7 CORES

ASD-AC30	<p>CROMOTERAPIA</p> <p>A cromoterapia é um tratamento terapêutico alternativo ou complementar que usa a natureza da cor e da sua vibração para estabelecer o equilíbrio biológico e a harmonia das faculdades mentais e dos estados emocionais restaurando o equilíbrio físico-energético em áreas do corpo humano atingidas por alguma disfunção.</p> <p>Acromoterapia usa as cores do espectro solar.</p>	548 750,00	625 575,00
-----------------	---	------------	-------------------



PES P/ BANHEIRA

ASD-AC70	PES APOIO BANHEIRA 120/170	22 750,00	25 935,00
ASD-AC71	PES APOIO BANHEIRA 180/200	29 750,00	33 915,00
ASD-AC72	PES APOIO BANHEIRA CHARME CANTO	32 750,00	37 335,00

PES P/ PAINÉIS

ASD-AC75	PES PAINEL FRONTAL 3 und	18 750,00	21 375,00
ASD-AC76	PES PAINEL FRONTAL 2 und.	12 750,00	14 535,00



PEGAS BANHEIRA

ASD-AC80	PEGAS CROMADAS 2 und	98 950,00	112 803,00
-----------------	----------------------	-----------	-------------------

Grelha dupla função:
Lisa ou para acabamento
cerâmico



Cartucho anti odor

CALHA DUCHE SIFONADA RECTA

SE-051	RECTA 74x11 / AISI 304 + PP	128 750,00	146 775,00
SE-052	RECTA 84x11 / AISI 304 + PP	136 750,00	155 895,00



CALHA DUCHE SIFONADA CANTO

SE-050-1	CANTO 23x23 / AISI 304 + ABS	98 750,00	112 575,00
-----------------	------------------------------	-----------	-------------------

**ESTRADOS P/ BASE PLANISSIMA**

130.035	MADEIRA P/ BASE QUADRADA PLANISSIMA	75x75	98 950,00	112 803,00
130.038	MADEIRA P/ BASE QUADRADA PLANISSIMA	100x100	128 950,00	147 003,00
130.040	MADEIRA P/ BASE CANTO PLANISSIMA	80	98 950,00	112 803,00
130.041	MADEIRA P/ BASE CANTO PLANISSIMA	90	108 950,00	124 203,00
130.044	MADEIRA P/ BASE RECTANGULAR PLANISSIMA	90x80	98 950,00	112 803,00
130.045	MADEIRA P/ BASE RECTANGULAR PLANISSIMA	100x70	104 950,00	119 643,00
130.047	MADEIRA P/ BASE RECTANGULAR PLANISSIMA	100x80	108 950,00	124 203,00
130.048	MADEIRA P/ BASE RECTANGULAR PLANISSIMA	100x90	112 950,00	128 763,00
130.050	MADEIRA P/ BASE RECTANGULAR PLANISSIMA	110x75	108 950,00	124 203,00
130.051	MADEIRA P/ BASE RECTANGULAR PLANISSIMA	110x80	114 950,00	131 043,00
130.052	MADEIRA P/ BASE RECTANGULAR PLANISSIMA	110x90	118 950,00	135 603,00
130.054	MADEIRA P/ BASE RECTANGULAR PLANISSIMA	120x75	124 950,00	142 443,00
130.055	MADEIRA P/ BASE RECTANGULAR PLANISSIMA	120x80	128 950,00	147 003,00
130.066	MADEIRA P/ BASE RECTANGULAR PLANISSIMA	150x75	148 950,00	169 803,00
130.078	MADEIRA P/ BASE RECTANGULAR PLANISSIMA	180x75	198 950,00	226 803,00
130.083	MADEIRA P/ BASE RECTANGULAR PLANISSIMA	200x80	228 950,00	261 003,00

**TORNEIRAS / ENCASTRE DE BANHEIRA**

ASD-AC50	EXTRAPLANO MONOCOMANDO DE ENCASTRAR 3 FUROS C/ CHUVEIRO DE MÃO ANTIGOTAS	862 950,00	983 763,00
-----------------	--	------------	-------------------



ASD-AC51	QUADRADO MONOCOMANDO DE ENCASTRAR 3 FUROS C/ CHUVEIRO DE MÃO ANTIGOTAS	585 950,00	667 983,00
-----------------	--	------------	-------------------



ASD-AC52	CILINDRICO MONOCOMANDO DE ENCASTRAR 3 FUROS C/ CHUVEIRO DE MÃO ANTIGOTAS	526 950,00	600 723,00
-----------------	--	------------	-------------------

**ENCOSTOS**

ASD-AC40	CHARME CANTO ENCOSTO BANHEIRA	95 250,00	108 585,00
ASD-AC41	CLASSICA ENCOSTO BANHEIRA	95 250,00	108 585,00
ASD-AC42	PLANISSIMA ENCOSTO BANHEIRA	95 250,00	108 585,00
ASD-AC43	PLANISSIMA DUO ENCOSTO BANHEIRA	95 250,00	108 585,00



SIFÃO DE PAVIMENTO

SE-055

SQUARE HORIZONTAL:
SIFÃO DE PAVIMENTO COM CORPO EM PVC
GRELHA INOX AISI 304 - ANTI-ODORES

19 750,00

22 515,00



SE-056

SQUARE VERTICAL:
SIFÃO DE PAVIMENTO COM CORPO EM PVC
GRELHA INOX AISI 304 - ANTI-ODORES

19 750,00

22 515,00



VALVULA CLIC CLAC BANHEIRA

SE-510

VALVULA:
PARA BANHEIRA COM CLIC CLAC
CORPO EM PVC

35 750,00

40 755,00



VALVULAS PARA BASE DE CHUVEIRO

SE-500

VALVULA SIFONADA 90 mm:
PLANISSIMA PARA BASE DE CHUVEIRO
CORPO EM ABS

18 750,00

21 375,00



SE-501

VALVULA SIFONADA 90 mm:
PARA BASE DE CHUVEIRO
CORPO EM ABS

14 750,00

16 815,00



SE-501-1

VALVULA SIFONADA 60 mm:
PARA BASE DE CHUVEIRO
CORPO EM ABS

8 750,00

9 975,00



TAMPAS PARA BASE STONE LUX

SE-400

PARA BASE DE CHUVEIRO STONE LUX
BRANCA

34 750,00

39 615,00

SE-401

PARA BASE DE CHUVEIRO STONE LUX
PRETA

34 750,00

39 615,00

SE-402

PARA BASE DE CHUVEIRO STONE LUX INOX

34 750,00

39 615,00



SIFÃO ARTICULADO 1-1/2

SE-202

PARA BASE DE CHUVEIRO E BANHEIRA
CORPO EM PVC 1-1/2

2 175,00

2 479,50





d!anna

RESGUARDOS



TERESA BRANCO

IT-BS762	RESGUARDO BASE LATERAL FIXO	80x200	260 750,00	297 255,00
IT-BS701	RESGUARDO BASE FRONTAL COM 1 PORTA DE CORRER	100x200	390 750,00	445 455,00
IT-BS702	RESGUARDO BASE FRONTAL COM 1 PORTA DE CORRER	110x200	422 750,00	481 935,00
IT-BS703	RESGUARDO BASE FRONTAL COM 1 PORTA DE CORRER	120x200	438 750,00	500 175,00
IT-BS704	RESGUARDO BASE FRONTAL COM 1 PORTA DE CORRER	130x200	471 750,00	537 795,00
IT-BS705	RESGUARDO BASE FRONTAL COM 1 PORTA DE CORRER	140x200	503 750,00	574 275,00
IT-BS706	RESGUARDO BASE FRONTAL COM 1 PORTA DE CORRER	150x200	520 750,00	593 655,00
IT-BS707	RESGUARDO BASE FRONTAL COM 1 PORTA DE CORRER	160x200	536 750,00	611 895,00
IT-BS708	RESGUARDO BASE FRONTAL COM 1 PORTA DE CORRER	170x200	552 750,00	630 135,00
IT-BS709	RESGUARDO BASE FRONTAL COM 1 PORTA DE CORRER	180x200	585 750,00	667 755,00
IT-BS710	RESGUARDO BASE FRONTAL COM 1 PORTA DE CORRER	190x200	617 750,00	704 235,00
IT-BS711	RESGUARDO BASE FRONTAL COM 1 PORTA DE CORRER	200x200	650 750,00	741 855,00



TERESA CROMADO

IT-BS772	RESGUARDO BASE LATERAL FIXO	80x200	292 750,00	333 735,00
IT-BS728	RESGUARDO BASE FRONTAL COM 1 PORTA DE CORRER	170x200	585 750,00	667 755,00
IT-BS729	RESGUARDO BASE FRONTAL COM 1 PORTA DE CORRER	180x200	601 750,00	685 995,00
IT-BS730	RESGUARDO BASE FRONTAL COM 1 PORTA DE CORRER	190x200	633 750,00	722 475,00
IT-BS731	RESGUARDO BASE FRONTAL COM 1 PORTA DE CORRER	200x200	682 750,00	778 335,00



TERESA PRETO

IT-BS780	RESGUARDO BASE LATERAL FIXO	80x200	292 750,00	333 735,00
IT-BS741	RESGUARDO BASE FRONTAL COM 1 PORTA DE CORRER	100x200	455 750,00	519 555,00
IT-BS743	RESGUARDO BASE FRONTAL COM 1 PORTA DE CORRER	120x200	487 750,00	556 035,00
IT-BS745	RESGUARDO BASE FRONTAL COM 1 PORTA DE CORRER	140x200	536 750,00	611 895,00
IT-BS747	RESGUARDO BASE FRONTAL COM 1 PORTA DE CORRER	160x200	585 750,00	667 755,00
IT-BS749	RESGUARDO BASE FRONTAL COM 1 PORTA DE CORRER	180x200	601 750,00	685 995,00

**LECI B CROMADO**

IT-BS120	RESGUARDO BASE LATERA FIXO	80x200	260 750,00	297 255,00
IT-BS110	RESGUARDO BASE FRONTAL COM 1 PORTA DE CORRER	100x200	406 750,00	463 695,00
IT-BS111	RESGUARDO BASE FRONTAL COM 1 PORTA DE CORRER	110x200	422 750,00	481 935,00
IT-BS112	RESGUARDO BASE FRONTAL COM 1 PORTA DE CORRER	120x200	438 750,00	500 175,00
IT-BS113	RESGUARDO BASE FRONTAL COM 1 PORTA DE CORRER	130x200	455 750,00	519 555,00
IT-BS114	RESGUARDO BASE FRONTAL COM 1 PORTA DE CORRER	140x200	471 750,00	537 795,00
IT-BS115	RESGUARDO BASE FRONTAL COM 1 PORTA DE CORRER	150x200	487 750,00	556 035,00
IT-BS116	RESGUARDO BASE FRONTAL COM 1 PORTA DE CORRER	160x200	503 750,00	574 275,00



RITA PRETO

IT-BS695	RESGUARDO QUADRADO COM 2 PORTAS DE CORRER	80xx80x200	633 750,00	722 475,00
-----------------	---	------------	------------	-------------------

IT-BS696	RESGUARDO QUADRADO COM 2 PORTAS DE CORRER	90x90x200	682 750,00	778 335,00
-----------------	---	-----------	------------	-------------------



RITA BRANCO

IT-BS680	RESGUARDO QUADRADO COM 2 PORTAS DE CORRER	70x70	298 750,00	340 575,00
-----------------	---	-------	------------	-------------------

IT-BS681	RESGUARDO QUADRADO COM 2 PORTAS DE CORRER	75x75	348 750,00	397 575,00
-----------------	---	-------	------------	-------------------



RITA CROMADO

IT-BS690	RESGUARDO QUADRADO COM 2 PORTAS DE CORRER	70x70	328 750,00	374 775,00
-----------------	---	-------	------------	-------------------

IT-BS691	RESGUARDO QUADRADO COM 2 PORTAS DE CORRER	75x75	368 750,00	420 375,00
-----------------	---	-------	------------	-------------------



LECI A CROMADO

IT-BS100	RESGUARDO CROMADO QUADRADO COM 2 PORTAS DE CORRER	80x80	598 750,00	682 575,00
-----------------	---	-------	------------	-------------------

IT-BS101	RESGUARDO CROMADO QUADRADO COM 2 PORTAS DE CORRER	90x90	617 750,00	704 235,00
-----------------	---	-------	------------	-------------------



POP STAR CROMADO

RB-RG160	RESGUARDO QUADRADO CROMADO COM 2 PORTAS DE CORRER	80x80	325 750,00	371 355,00
-----------------	---	-------	------------	-------------------

RB-RG161	RESGUARDO QUADRADO CROMADO COM 2 PORTAS DE CORRER	90x90	357 750,00	407 835,00
-----------------	---	-------	------------	-------------------



SARA CROMADO

380.421V	RESGUARDO QUADRADO CROMADO COM 2 PORTAS DE CORRER	70x70	248 750,00	283 575,00
-----------------	---	-------	------------	-------------------



MALANGE SERIGRAFADO CROMADO

380.781	RESGUARDO QUADRADO CROMADO SERIGRAFADO COM 2 PORTAS DE CORRER	70x70	248 750,00	283 575,00
----------------	---	-------	------------	-------------------

380.782	RESGUARDO QUADRADO CROMADO SERIGRAFADO COM 2 PORTAS DE CORRER	75x75	298 750,00	340 575,00
----------------	---	-------	------------	-------------------



LECI A-N20

IT-BS104	RESGUARDO QUADRADO CROMADO COM 2 PORTAS DE CORRER	75x75	504 750,00	575 415,00
IT-BS104-1	RESGUARDO RECTANGULAR CROMADO COM 2 PORTAS DE CORRER	75x80	506 750,00	577 695,00
IT-BS104-2	RESGUARDO RECTANGULAR CROMADO COM 2 PORTAS DE CORRER	75x90	512 750,00	584 535,00
IT-BS104-3	RESGUARDO RECTANGULAR CROMADO COM 2 PORTAS DE CORRER	75x100	528 750,00	602 775,00
IT-BS104-4	RESGUARDO RECTANGULAR CROMADO COM 2 PORTAS DE CORRER	75x120	536 750,00	611 895,00
IT-BS105	RESGUARDO QUADRADO CROMADO COM 2 PORTAS DE CORRER	80x80	508 750,00	579 975,00
IT-BS105-1	RESGUARDO RECTANGULAR CROMADO COM 2 PORTAS DE CORRER	80x90	514 750,00	586 815,00
IT-BS105-2	RESGUARDO RECTANGULAR CROMADO COM 2 PORTAS DE CORRER	80x100	530 750,00	605 055,00
IT-BS105-3	RESGUARDO RECTANGULAR CROMADO COM 2 PORTAS DE CORRER	80x120	538 750,00	614 175,00
IT-BS106	RESGUARDO QUADRADO CROMADO COM 2 PORTAS DE CORRER	90x90	520 750,00	593 655,00
IT-BS106-1	RESGUARDO RECTANGULAR CROMADO COM 2 PORTAS DE CORRER	90x100	536 750,00	611 895,00
IT-BS106-2	RESGUARDO RECTANGULAR CROMADO COM 2 PORTAS DE CORRER	90x120	544 750,00	621 015,00
IT-BS107	RESGUARDO QUADRADO CROMADO COM 2 PORTAS DE CORRER	100x100	552 750,00	630 135,00
IT-BS107-1	RESGUARDO RECTANGULAR CROMADO COM 2 PORTAS DE CORRER	100x120	560 750,00	639 255,00
IT-BS108	RESGUARDO QUADRADO CROMADO COM 2 PORTAS DE CORRER	120x120	568 750,00	648 375,00

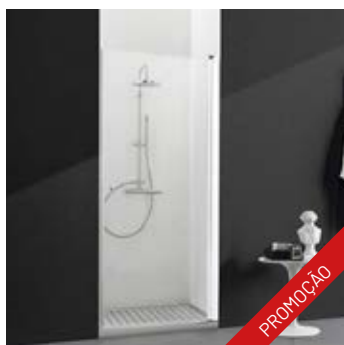

MANUELA BRANCO

IT-BS170-1	RESGUARDO BRANCO BASE FRONTAL COM 1 PORTA ABRIR	70x185	243 750,00	277 875,00
IT-BS170	RESGUARDO BRANCO BASE FRONTAL COM 1 PORTA ABRIR	70x200	276 750,00	315 495,00
IT-BS172-1	RESGUARDO BRANCO BASE FRONTAL COM 1 PORTA ABRIR	80x185	276 750,00	315 495,00
IT-BS172	RESGUARDO BRANCO BASE FRONTAL COM 1 PORTA ABRIR	80x200	308 750,00	351 975,00
IT-BS173	RESGUARDO BRANCO BASE FRONTAL COM 1 PORTA ABRIR	90x200	325 750,00	371 355,00
IT-BS174-1	RESGUARDO BRANCO BASE FRONTAL COM 1 PORTA ABRIR	100x185	357 750,00	407 835,00
IT-BS174	RESGUARDO BRANCO BASE FRONTAL COM 1 PORTA ABRIR	100x200	390 750,00	445 455,00



MANUELA CROMADO

IT-BS180	RESGUARDO CROMADO BASE FRONTAL COM 1 PORTA ABRIR	70x200	292 750,00	333 735,00
IT-BS182-1	RESGUARDO CROMADO BASE FRONTAL COM 1 PORTA ABRIR	80x185	325 750,00	371 355,00
IT-BS182	RESGUARDO CROMADO BASE FRONTAL COM 1 PORTA ABRIR	80x200	357 750,00	407 835,00
IT-BS183-1	RESGUARDO CROMADO BASE FRONTAL COM 1 PORTA ABRIR	90x185	341 750,00	389 595,00
IT-BS183	RESGUARDO CROMADO BASE FRONTAL COM 1 PORTA ABRIR	90x200	373 750,00	426 075,00
IT-BS184-1	RESGUARDO CROMADO BASE FRONTAL COM 1 PORTA ABRIR	100x185	373 750,00	426 075,00
IT-BS184	RESGUARDO CROMADO BASE FRONTAL COM 1 PORTA ABRIR	100x200	406 750,00	463 695,00



MADALENA

IT-BS151	RESGUARDO BRANCO BASE FRONTAL COM 2 PORTAS ABRIR	90x185	398 750,00	454 575,00
IT-BS161	RESGUARDO CROMADO BASE FRONTAL COM 2 PORTAS ABRIR	90x185	398 750,00	454 575,00
IT-BS162	RESGUARDO CROMADO BASE FRONTAL COM 2 PORTAS ABRIR	100x185	398 750,00	454 575,00

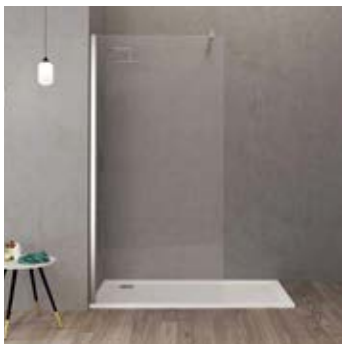

LECI C CROMADO

IT-BS127	PAINEL FIXO	20x200	98 750,00	112 575,00
IT-BS128	PAINEL FIXO	30x200	195 750,00	223 155,00
IT-BS129	PAINEL FIXO	70x200	258 750,00	294 975,00
IT-BS130	PAINEL FIXO	80x200	278 750,00	317 775,00
IT-BS131	PAINEL FIXO	90x200	300 750,00	342 855,00
IT-BS132	PAINEL FIXO	100x200	318 750,00	363 375,00
IT-BS132-1	PAINEL FIXO	110x200	334 750,00	381 615,00
IT-BS133	PAINEL FIXO	120x200	352 750,00	402 135,00
IT-BS134	PAINEL FIXO	140x200	398 750,00	454 575,00



LECI C BRANCO

IT-BS127/B	PAINEL FIXO	20x200	98 750,00	112 575,00
IT-BS130/B	PAINEL FIXO	80x200	278 750,00	317 775,00
IT-BS132/B	PAINEL FIXO	100x200	318 750,00	363 375,00
IT-BS133/B	PAINEL FIXO	120x200	352 750,00	402 135,00
IT-BS134/B	PAINEL FIXO	140x200	398 750,00	454 575,00



LECI C PRETO

IT-BS127/P	PAINEL FIXO	20x200	98 750,00	112 575,00
IT-BS128/P	PAINEL FIXO	30x200	195 750,00	223 155,00
IT-BS130/P	PAINEL FIXO	80x200	278 750,00	317 775,00
IT-BS132/P	PAINEL FIXO	100x200	318 750,00	363 375,00
IT-BS133/P	PAINEL FIXO	120x200	352 750,00	402 135,00
IT-BS134/P	PAINEL FIXO	140x200	398 750,00	454 575,00

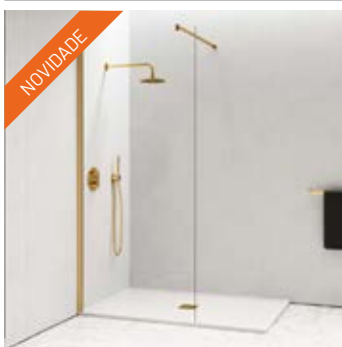

LECI C DOURADO

IT-BS128/O	PAINEL FIXO VIDRO	30x200	244 750,00	279 015,00
IT-BS130/O	PAINEL FIXO VIDRO	80x200	358 750,00	408 975,00
IT-BS132/O	PAINEL FIXO VIDRO	100x200	416 750,00	475 095,00
IT-BS133/O	PAINEL FIXO VIDRO	120x200	464 750,00	529 815,00



COMPATÍVEL COM BASE PLANÍSSIMA / CLÁSSICA

RAFAELO BRANCO

IT-BS650	RESGUARDO BRANCO CANTO COM 2 PORTAS DE CORRER	75x185	298 750,00	340 575,00
IT-BS653	RESGUARDO BRANCO CANTO COM 2 PORTAS DE CORRER	100x185	428 750,00	488 775,00



COMPATÍVEL COM BASE PLANÍSSIMA / CLÁSSICA

RAFAELO CROMADO

IT-BS660	RESGUARDO CROMADO CANTO COM 2 PORTAS DE CORRER	75x185	298 750,00	340 575,00
IT-BS663	RESGUARDO CROMADO CANTO COM 2 PORTAS DE CORRER	100x185	428 750,00	488 775,00



COMPATÍVEL COM BASE FACE

FACE CROMADO

380.303	RESGUARDO CROMADO CANTO COM 2 PORTAS DE CORRER	80x195	348 750,00	397 575,00
380.304	RESGUARDO CROMADO CANTO COM 2 PORTAS DE CORRER	90x195	388 750,00	443 175,00
380.305	RESGUARDO CROMADO CANTO COM 2 PORTAS DE CORRER	100x195	428 750,00	488 775,00



COMPATÍVEL COM BASE ELSY / MORAIRA

ELSY CROMADO

380.292	RESGUARDO CROMADO CANTO COM 2 PORTAS DE CORRER	75x185	298 750,00	340 575,00
----------------	--	--------	------------	-------------------



COMPATÍVEL COM BASE ELSY / MORAIRA

MORAIRA CROMADO

380.324	RESGUARDO CROMADO CANTO COM 2 PORTAS DE CORRER	75x195	298 750,00	340 575,00
----------------	--	--------	------------	-------------------

380.326	RESGUARDO CROMADO CANTO COM 2 PORTAS DE CORRER	90x195	388 750,00	443 175,00
----------------	--	--------	------------	-------------------



COMPATÍVEL COM BASE ELSY / MORAIRA

CACUACO BRANCO

380.277	RESGUARDO BRANCO CANTO COM 2 PORTAS DE CORRER	75x190	298 750,00	340 575,00
----------------	---	--------	------------	-------------------

380.279	RESGUARDO BRANCO CANTO COM 2 PORTAS DE CORRER	90x190	388 750,00	443 175,00
----------------	---	--------	------------	-------------------



COMPATÍVEL COM BASE ELSY / MORAIRA

CAMAMA SERIGRAFADO CROMADO

380.271	RESGUARDO CROMADO SERIGRAFADO CANTO COM 2 PORTAS DE CORRER	75x190	298 750,00	340 575,00
380.272	RESGUARDO CROMADO SERIGRAFADO CANTO COM 2 PORTAS DE CORRER	80x190	348 750,00	397 575,00
380.273	RESGUARDO CROMADO SERIGRAFADO CANTO COM 2 PORTAS DE CORRER	90x190	388 750,00	443 175,00



COMPATÍVEL COM BASE FACE

GAMEK SERIGRAFADO CROMADO

380.315	RESGUARDO CROMADO SERIGRAFADO CANTO COM 2 PORTAS DE CORRER	80x190	348 750,00	397 575,00
380.316	RESGUARDO CROMADO SERIGRAFADO CANTO COM 2 PORTAS DE CORRER	90x190	388 750,00	443 175,00
380.317	RESGUARDO CROMADO SERIGRAFADO CANTO COM 2 PORTAS DE CORRER	100x190	428 750,00	488 775,00



COMPATÍVEL COM BASE PLANÍSSIMA / CLÁSSICA

HUAMBO SERIGRAFADO CROMADO

380.761	RESGUARDO CROMADO SERIGRAFADO CANTO COM 2 PORTAS DE CORRER	75x185	298 750,00	340 575,00
----------------	--	--------	------------	-------------------

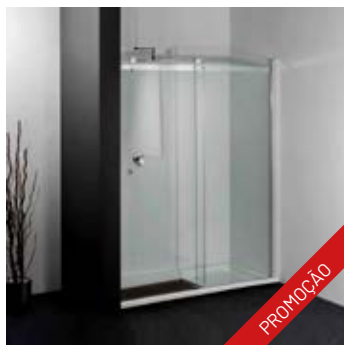

COMPATÍVEL COM BASE ELSY / MORAIRA

STRADO CROMADO

380.400	RESGUARDO CROMADO FRONTAL BASE COM 1 PORTAS DE CORRER	100x200 DIREITO	498 750,00	568 575,00
380.401	RESGUARDO CROMADO FRONTAL BASE COM 1 PORTAS DE CORRER	100x200 ESQUERDO	498 750,00	568 575,00
380.402	RESGUARDO CROMADO FRONTAL BASE COM 1 PORTAS DE CORRER	120x200 DIREITO	548 750,00	625 575,00
380.403	RESGUARDO CROMADO FRONTAL BASE COM 1 PORTAS DE CORRER	120x200 ESQUERDO	548 750,00	625 575,00
380.405	RESGUARDO CROMADO FRONTAL BASE COM 1 PORTAS DE CORRER	140x200 ESQUERDO	588 750,00	671 175,00
380.407	RESGUARDO CROMADO FRONTAL BASE COM 1 PORTAS DE CORRER	160x200 ESQUERDO	628 750,00	716 775,00

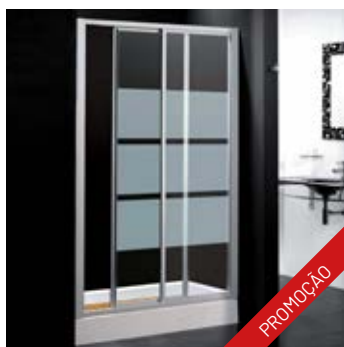

COMPATÍVEL COM BASE FACE

CORIMBA SERIGRAFADO CROMADO

380.181	RESGUARDO CROMADO SERIGRAFADO FRONTAL BASE COM 1 PORTAS DE CORRER	190x185	428 750,00	488 775,00
380.182	RESGUARDO CROMADO SERIGRAFADO FRONTAL BASE COM 1 PORTAS DE CORRER	200x185	448 750,00	511 575,00

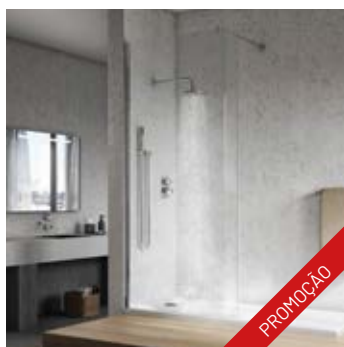

COMPATÍVEL COM BASE PLANÍSSIMA / CLÁSSICA

PR CURVO BRANCO

IT-BS500	PAINEL FIXO CROMADO CURVO	80+20x200	888 750,00	1 013 175,00
-----------------	---------------------------	-----------	------------	---------------------



IT 230

IT-BN050 DIREITO	PAINEL FRONTAL BANHEIRA C/ PORTA DE CORRER	60+60x150	812 750,00	926 535,00
-----------------------------------	--	-----------	------------	-------------------

IT-BN051 ESQUERDO	PAINEL FRONTAL BANHEIRA C/ PORTA DE CORRER	60+60x150	812 750,00	926 535,00
------------------------------------	--	-----------	------------	-------------------



ARQ 220

IT-BN010 DIREITO	PAINEL FRONTAL BANHEIRA C/ PORTA DE ABRIR	70+50x150	780 750,00	890 055,00
-----------------------------------	---	-----------	------------	-------------------

IT-BN011 ESQUERDO	PAINEL FRONTAL BANHEIRA C/ PORTA DE ABRIR	70+50x150	780 750,00	890 055,00
------------------------------------	---	-----------	------------	-------------------



MARA DUPLO BRANCO

IT-BN110	PAINEL BANHEIRA DUPLO	80+45x150	633 750,00	722 475,00
-----------------	-----------------------	-----------	------------	-------------------

MARA DUPLO CROMADO

IT-BN111	PAINEL BANHEIRA DUPLO	80+45x150	682 750,00	778 335,00
-----------------	-----------------------	-----------	------------	-------------------



MÓNICA BRANCO

IT-BN130	PAINEL BANHEIRA	85x140	227 750,00	259 635,00
-----------------	-----------------	--------	------------	-------------------

MÓNICA CROMADO

IT-BN131	PAINEL BANHEIRA	85x140	260 750,00	297 255,00
-----------------	-----------------	--------	------------	-------------------



VIKING DUPLO CROMADO

RB-RG221	PAINEL DE BANHEIRA DUPLO	100x140	276 750,00	315 495,00
-----------------	--------------------------	---------	------------	-------------------



VIKING CROMADO

RB-RG220	PAINEL DE BANHEIRA SIMPLES	80x140	211 750,00	241 395,00
-----------------	----------------------------	--------	------------	-------------------



PR 620 CROMADO

IT-BN210	PAINEL DE BANHEIRA FIXO SIMPLES	120x140	198 750,00	226 575,00
-----------------	---------------------------------	---------	------------	-------------------

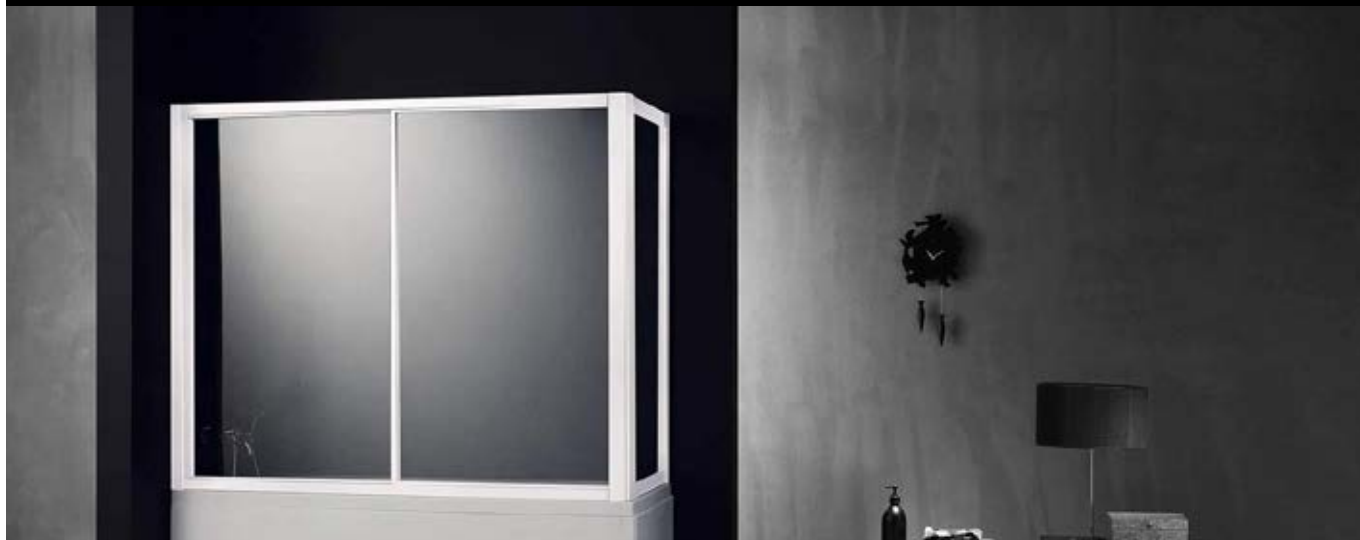
**TERESA BRANCO**

IT-BN321	RESGUARDO BRANCO BANHEIRA LATERAL FIXO	75x140	168 750,00	192 375,00
IT-BN322	RESGUARDO BRANCO BANHEIRA LATERAL FIXO	80x140	178 750,00	203 775,00
IT-BN323	RESGUARDO BRANCO BANHEIRA LATERAL FIXO	90x140	188 750,00	215 175,00
IT-BN324	RESGUARDO BRANCO BANHEIRA LATERAL FIXO	100x140	198 750,00	226 575,00
IT-BN301	RESGUARDO BRANCO BANHEIRA FRONTAL COM 1 PORTA DE CORRER	135x140	198 750,00	226 575,00
IT-BN302	RESGUARDO BRANCO BANHEIRA FRONTAL COM 1 PORTA DE CORRER	140x140	208 750,00	237 975,00
IT-BN304	RESGUARDO BRANCO BANHEIRA FRONTAL COM 1 PORTA DE CORRER	160x140	228 750,00	260 775,00
IT-BN307	RESGUARDO BRANCO BANHEIRA FRONTAL COM 1 PORTA DE CORRER	190x140	258 750,00	294 975,00
IT-BN308	RESGUARDO BRANCO BANHEIRA FRONTAL COM 1 PORTA DE CORRER	200x140	268 750,00	306 375,00

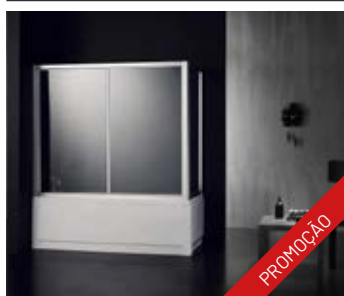
**TERESA CROMADO**

IT-BN331	RESGUARDO CROMADO BANHEIRA LATERAL FIXO	75x140	168 750,00	192 375,00
IT-BN332	RESGUARDO CROMADO BANHEIRA LATERAL FIXO	80x140	178 750,00	203 775,00
IT-BN333	RESGUARDO CROMADO BANHEIRA LATERAL FIXO	90x140	188 750,00	215 175,00
IT-BN334	RESGUARDO CROMADO BANHEIRA LATERAL FIXO	100x140	198 750,00	226 575,00
IT-BN310	RESGUARDO CROMADO BANHEIRA FRONTAL COM 1 PORTA DE CORRER	120x140	188 750,00	215 175,00
IT-BN311	RESGUARDO CROMADO BANHEIRA FRONTAL COM 1 PORTA DE CORRER	135x140	198 750,00	226 575,00
IT-BN312	RESGUARDO CROMADO BANHEIRA FRONTAL COM 1 PORTA DE CORRER	140x140	208 750,00	237 975,00
IT-BN313	RESGUARDO CROMADO BANHEIRA FRONTAL COM 1 PORTA DE CORRER	150x140	218 750,00	249 375,00
IT-BN314	RESGUARDO CROMADO BANHEIRA FRONTAL COM 1 PORTA DE CORRER	160x140	228 750,00	260 775,00
IT-BN315	RESGUARDO CROMADO BANHEIRA FRONTAL COM 1 PORTA DE CORRER	170x140	238 750,00	272 175,00
IT-BN316	RESGUARDO CROMADO BANHEIRA FRONTAL COM 1 PORTA DE CORRER	180x140	248 750,00	283 575,00
IT-BN317	RESGUARDO CROMADO BANHEIRA FRONTAL COM 1 PORTA DE CORRER	190x140	258 750,00	294 975,00
IT-BN318	RESGUARDO CROMADO BANHEIRA FRONTAL COM 1 PORTA DE CORRER	200x140	268 750,00	306 375,00



MAIANGA SERIGRAFADO CROMADO

IT-BN105	RESGUARDO CROMADO BANHEIRA LATERAL FIXO	70x140	168 750,00	192 375,00
IT-BN106	RESGUARDO CROMADO BANHEIRA LATERAL FIXO	80x140	178 750,00	203 775,00
IT-BN107	RESGUARDO CROMADO BANHEIRA LATERAL FIXO	90x140	188 750,00	215 175,00

IT-BN100	RESGUARDO CROMADO BANHEIRA FRONTAL COM 1 PORTA DE CORRER	160x140	228 750,00	260 775,00
IT-BN101	RESGUARDO CROMADO BANHEIRA FRONTAL COM 1 PORTA DE CORRER	170x140	238 750,00	272 175,00
IT-BN102	RESGUARDO CROMADO BANHEIRA FRONTAL COM 1 PORTA DE CORRER	180x140	248 750,00	283 575,00
IT-BN103	RESGUARDO CROMADO BANHEIRA FRONTAL COM 1 PORTA DE CORRER	190x140	258 750,00	294 975,00
IT-BN104	RESGUARDO CROMADO BANHEIRA FRONTAL COM 1 PORTA DE CORRER	200x140	268 750,00	306 375,00



MILENIO ACRÍLICO CROMADO

IT-BN120	RESGUARDO CROMADO ACRILICO BANHEIRA FRONTAL COM 2 PORTAS CORRER	150x140	218 750,00	249 375,00
IT-BN121	RESGUARDO CROMADO ACRILICO BANHEIRA FRONTAL COM 2 PORTAS CORRER	160x140	228 750,00	260 775,00
IT-BN122	RESGUARDO CROMADO ACRILICO BANHEIRA FRONTAL COM 2 PORTAS CORRER	170x140	238 750,00	272 175,00
IT-BN123	RESGUARDO CROMADO ACRILICO BANHEIRA FRONTAL COM 2 PORTAS CORRER	180x140	248 750,00	283 575,00

**UIGE**

375.210	RESGUARDO BRANCO ACRILICO BANHEIRA LATERAL FIXO	80x140	178 750,00	203 775,00
375.200	RESGUARDO BRANCO ACRILICO BANHEIRA FRONTAL COM 1 PORTA CORRER	120x140	188 750,00	215 175,00
375.201	RESGUARDO BRANCO ACRILICO BANHEIRA FRONTAL COM 1 PORTA CORRER	135x140	198 750,00	226 575,00
375.202	RESGUARDO BRANCO ACRILICO BANHEIRA FRONTAL COM 1 PORTA CORRER	140x140	208 750,00	237 975,00
375.203	RESGUARDO BRANCO ACRILICO BANHEIRA FRONTAL COM 1 PORTA CORRER	150x140	218 750,00	249 375,00
375.206	RESGUARDO BRANCO ACRILICO BANHEIRA FRONTAL COM 1 PORTA CORRER	180x140	248 750,00	283 575,00
375.207	RESGUARDO BRANCO ACRILICO BANHEIRA FRONTAL COM 1 PORTA CORRER	190x140	258 750,00	294 975,00
375.208	RESGUARDO BRANCO ACRILICO BANHEIRA FRONTAL COM 1 PORTA CORRER	200x140	268 750,00	306 375,00

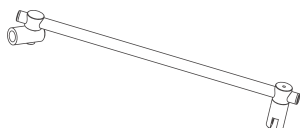
COMPLEMENTOS PARA RESGUARDOS**FIXADOR 45º**

IT-AC100	PR 500 FIXADOR 45º	BRANCO	97 750,00	111 435,00
IT-AC101	PR 500 FIXADOR 45º	CROMADO	97 750,00	111 435,00
IT-AC102	PR 500 FIXADOR 45º	PRETO	97 750,00	111 435,00
IT-AC103	PR 500 FIXADOR 45º	DOURADO	146 750,00	167 295,00

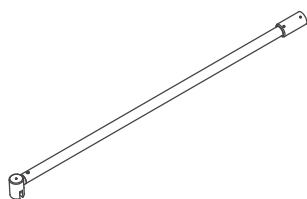
**FIXADOR 90º**

IT-AC110	PR 500 FIXADOR 90º	BRANCO	97 750,00	111 435,00
IT-AC111	PR 500 FIXADOR 90º	CROMADO	97 750,00	111 435,00
IT-AC112	PR 500 FIXADOR 90º	PRETO	97 750,00	111 435,00
IT-AC113	PR 500 FIXADOR 90º	DOURADO	146 750,00	167 295,00

**PERFIS DE COMPENSAÇÃO**

IT-AC216	PERFIL DE COMPENSAÇÃO BRANCO	4x4x200	65 750,00	74 955,00
IT-AC214	PERFIL DE COMPENSAÇÃO CROMADO	4x4x200	65 750,00	74 955,00
IT-AC215	PERFIL DE COMPENSAÇÃO PRETO	4x4x200	65 750,00	74 955,00
IT-AC218	PERFIL DE COMPENSAÇÃO LECI	2x2x200	58 750,00	66 975,00



d!anna



TORNEIRAS



PIPELINE COLLECTION



BM-M161/B

PIPELINE MONOCOMANDO LAVATÓRIO ALTO BRONZE

672 250,00

766 365,00

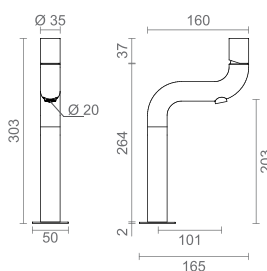

BM-M160/B

PIPELINE MONOCOMANDO LAVATÓRIO / BIDÊ BRONZE

528 250,00

602 205,00

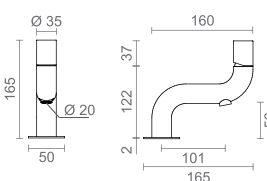

BM-M166/B

PIPELINE COLUNA DE DUCHE BRONZE

2 720 250,00

3 101 085,00

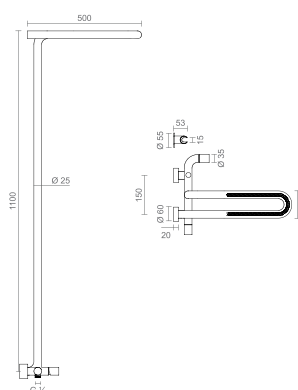



STRAW COLLECTION



BM-M191

STRAW MONOCOMANDO LAVATÓRIO ALTO CROMADO

528 250,00

602 205,00

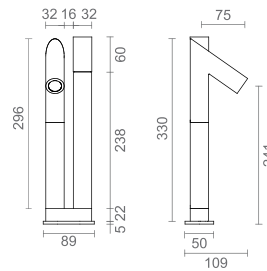

BM-M190

STRAW MONOCOMANDO LAVATÓRIO / BIDÉ CROMADO

398 750,00

454 575,00

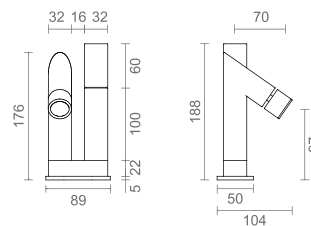



SMOOTH COLLECTION

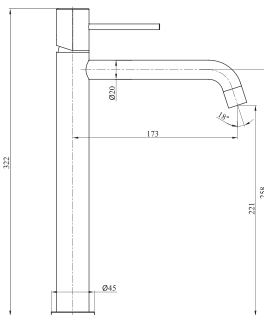

	RB-T191	SMOOTH MONOCOMANDO LAVATÓRIO ALTO CROMADO	144 250,00	164 445,00
	RB-T191/B	SMOOTH MONOCOMANDO LAVATÓRIO ALTO BRANCO	148 250,00	169 005,00
	RB-T191/P	SMOOTH MONOCOMANDO LAVATÓRIO ALTO PRETO	148 250,00	169 005,00
	RB-T191/D	SMOOTH MONOCOMANDO LAVATÓRIO ALTO DOURADO ESCOVADO	182 250,00	207 765,00
	RB-T191/R	SMOOTH MONOCOMANDO LAVATÓRIO ALTO ROSA GOLD	182 250,00	207 765,00
	RB-T191/G	SMOOTH MONOCOMANDO LAVATÓRIO ALTO GUN METAL	182 250,00	207 765,00

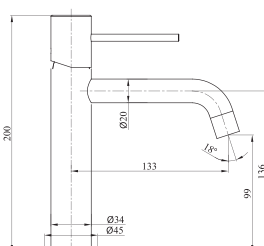

	RB-T190	SMOOTH MONOCOMANDO LAVATÓRIO CROMADO	104 250,00	118 845,00
	RB-T190/B	SMOOTH MONOCOMANDO LAVATÓRIO BRANCO	118 250,00	134 805,00
	RB-T190/P	SMOOTH MONOCOMANDO LAVATÓRIO PRETO	118 250,00	134 805,00
	RB-T190/D	SMOOTH MONOCOMANDO LAVATÓRIO DOURADO ESCOVADO	142 250,00	162 165,00
	RB-T190/R	SMOOTH MONOCOMANDO LAVATÓRIO ROSA GOLD	142 250,00	162 165,00
	RB-T190/G	SMOOTH MONOCOMANDO LAVATÓRIO GUN METAL	142 250,00	162 165,00

NOVIDADE

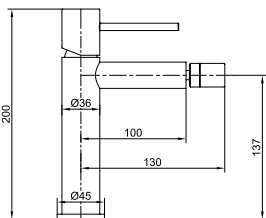

	RB-T193	SMOOTH MONOCOMANDO BIDÉ CROMADO	128 250,00	146 205,00
	RB-T193/B	SMOOTH MONOCOMANDO BIDÉ BRANCO	128 250,00	146 205,00
	RB-T193/P	SMOOTH MONOCOMANDO BIDÉ PRETO	128 250,00	146 205,00
	RB-T193/D	SMOOTH MONOCOMANDO BIDÉ DOURADO ESCOVADO	162 250,00	184 965,00
	RB-T193/R	SMOOTH MONOCOMANDO BIDÉ ROSA GOLD	162 250,00	184 965,00
	RB-T193/G	SMOOTH MONOCOMANDO BIDÉ GUN METAL	162 250,00	184 965,00

NOVIDADE

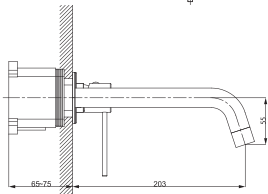
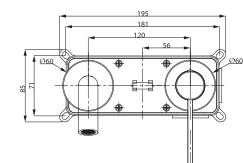

	RB-T192	MONOCOMANDO LAVATÓRIO ENCASTRE CROMADO	166 250,00	189 525,00
	RB-T192/B	MONOCOMANDO LAVATÓRIO ENCASTRE BRANCO	198 250,00	226 005,00
	RB-T192/P	MONOCOMANDO LAVATÓRIO ENCASTRE PRETO	198 250,00	226 005,00
	RB-T192/D	MONOCOMANDO LAVATÓRIO ENCASTRE DOURADO ESCOVADO	232 250,00	264 765,00
	RB-T192/R	MONOCOMANDO LAVATÓRIO ENCASTRE ROSA GOLD	232 250,00	264 765,00
	RB-T192/G	MONOCOMANDO LAVATÓRIO ENCASTRE GUN METAL	232 250,00	264 765,00

NOVIDADE

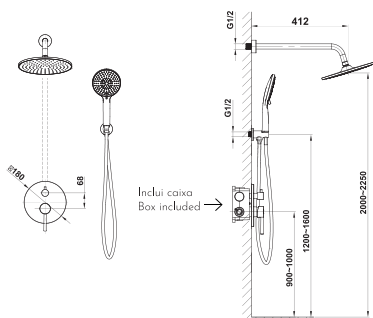

	RB-T197	CONJUNTO ENCASTRE 2 VIAS CROMADO	358 250,00	408 405,00
	RB-T197/B	CONJUNTO ENCASTRE 2 VIAS BRANCO	358 250,00	408 405,00
	RB-T197/P	CONJUNTO ENCASTRE 2 VIAS PRETO	358 250,00	408 405,00
	RB-T197/D	CONJUNTO ENCASTRE 2 VIAS DOURADO ESCOV.	412 250,00	469 965,00
	RB-T197/R	CONJUNTO ENCASTRE 2 VIAS ROSA GOLD	412 250,00	469 965,00
	RB-T197/G	CONJUNTO ENCASTRE 2 VIAS GUN METAL	412 250,00	469 965,00

NOVIDADE

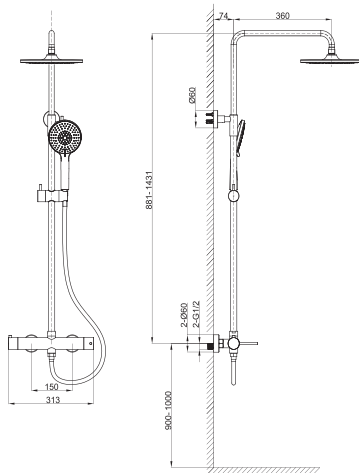

	RB-T196 SMOOTH COLUNA DUCHE C/ CHUVEIRO CROMADO	368 250,00	419 805,00
	RB-T196/B SMOOTH COLUNA DUCHE C/ CHUVEIRO BRANCO	412 250,00	469 965,00
	RB-T196/P SMOOTH COLUNA DUCHE C/ CHUVEIRO PRETO	412 250,00	469 965,00
	RB-T196/D SMOOTH COLUNA DUCHE C/ CHUVEIRO DOURADO ESCOV.	568 250,00	647 805,00
	RB-T196/R SMOOTH COLUNA DUCHE C/ CHUVEIRO ROSA GOLD	568 250,00	647 805,00
	RB-T196/G SMOOTH COLUNA DUCHE C/ CHUVEIRO GUN METAL	568 250,00	647 805,00

NOVIDADE

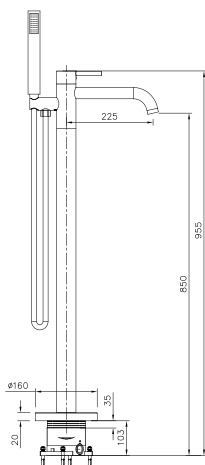

	RB-T198 MONOCOMANDO BANHEIRA AO CHÃO CROMADO	812 250,00	925 965,00
	RB-T198/B MONOCOMANDO BANHEIRA AO CHÃO BRANCO	812 250,00	925 965,00
	RB-T198/P MONOCOMANDO BANHEIRA AO CHÃO PRETO	812 250,00	925 965,00
	RB-T198/D MONOCOMANDO BANHEIRA AO CHÃO DOURADO ESCOV.	898 250,00	1024 005,00
	RB-T198/R MONOCOMANDO BANHEIRA AO CHÃO ROSA GOLD	898 250,00	1024 005,00
	RB-T198/G MONOCOMANDO BANHEIRA AO CHÃO GRUN METAL	898 250,00	1024 005,00





PLANE COLLECTION



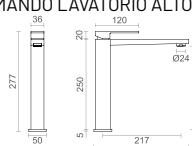

	BM-M171 MONOCOMANDO LAVATÓRIO ALTO CROMADO	256 250,00	292 125,00
	BM-M171/P MONOCOMANDO LAVATÓRIO ALTO PRETO	320 250,00	365 085,00



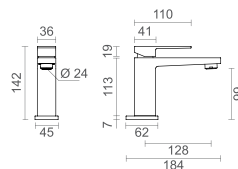

	BM-M170 MONOCOMANDO LAVATÓRIO CROMADO	147 250,00	167 865,00
	BM-M170/P MONOCOMANDO LAVATÓRIO PRETO	192 250,00	219 165,00

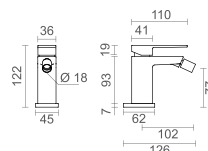

	BM-M173 MONOCOMANDO BIDÊ CROMADO	147 250,00	167 865,00
	BM-M173/P MONOCOMANDO BIDÊ PRETO	192 250,00	219 165,00



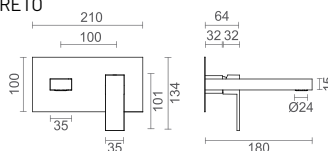

	BM-M172 MONOCOMANDO LAVATÓRIO ENCASTRE CROMADO	362 250,00	412 965,00
	BM-M172/P MONOCOMANDO LAVATÓRIO ENCASTRE PRETO	488 250,00	556 605,00

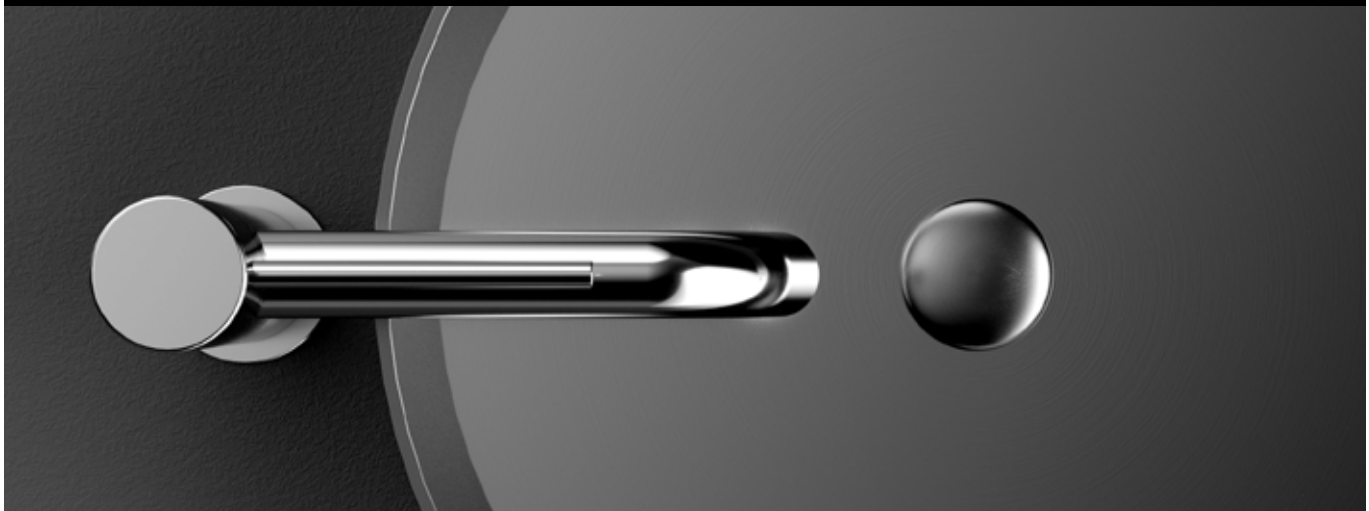







STYLE 25 / KNOBE COLLECTION

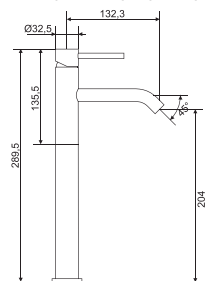

	CF-T191	MONOCOMANDO LAVATÓRIO ALTO CROMADO	207 750,00	236 835,00
	CF-T191/P	MONOCOMANDO LAVATÓRIO ALTO PRETO	270 750,00	308 655,00
	BM-M111/O	MONOCOMANDO LAVATÓRIO ALTO OURO	358 750,00	408 975,00



	CF-T190	MONOCOMANDO LAVATÓRIO CROMADO	127 750,00	145 635,00
	CF-T190/P	MONOCOMANDO LAVATÓRIO PRETO	173 750,00	198 075,00
	BM-M110/O	MONOCOMANDO LAVATÓRIO OURO	272 750,00	310 935,00

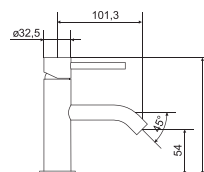

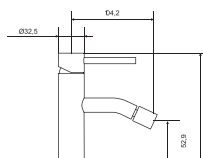

	CF-T193	MONOCOMANDO BIDÊ CROMADO	133 750,00	152 475,00
	CF-T193/P	MONOCOMANDO BIDÊ PRETO	189 750,00	216 315,00
	BM-M113/O	MONOCOMANDO BIDÊ OURO	272 750,00	310 935,00









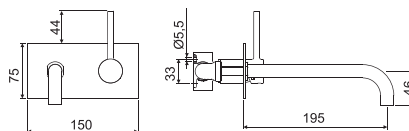

STYLE 25 / KNOBE COLLECTION

	CF-T192 MONOCOMANDO LAVATÓRIO ENCASTRE CROMADO	217 750,00	248 235,00
	CF-T192/P MONOCOMANDO LAVATÓRIO ENCASTRE PRETO	261 750,00	298 395,00
	BM-M112/O MONOCOMANDO LAVATÓRIO ENCASTRE OURO	568 750,00	648 375,00

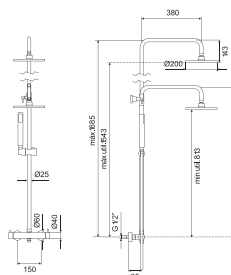



	CF-T199/C COLUNA DE DUCHE CROMADO	508 750,00	579 975,00
	CF-T199/P COLUNA DE DUCHE PRETO	654 750,00	746 415,00
	CF-T199/O COLUNA DE DUCHE OURO	1154 750,00	1316 415,00

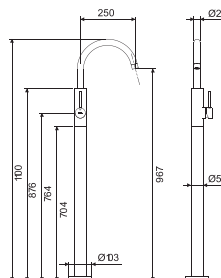

	CF-T209 MONOC. LAVATÓRIO AO CHÃO CROMADO	782 750,00	892 335,00
	CF-T209/P MONOC. LAVATÓRIO AO CHÃO PRETO	926 750,00	1056 495,00
	CF-T209/O MONOC. LAVATÓRIO AO CHÃO OURO	1166 750,00	1330 095,00



	CF-T208 MONOC. BANHEIRA AO CHÃO CROMADO	986 750,00	1124 895,00
	CF-T208/P MONOC. BANHEIRA AO CHÃO PRETO	1128 750,00	1286 775,00
	CFT208/O MONOC. BANHEIRA AO CHÃO OURO	1792 750,00	2043 735,00

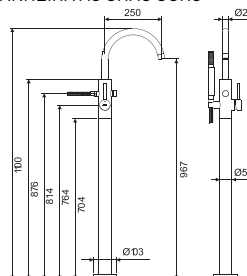

CF-T210	TH: SUPORTE PARA MONOCOMANDO AO CHÃO	198 750,00	226 575,00
----------------	--------------------------------------	------------	-------------------



QUADRADA COLECCION



● **DAV-T161**

MONOCOMANDO LAVATÓRIO ALTO

208 950,00

238 203,00

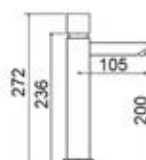

● **DAV-T160**

MONOCOMANDO LAVATÓRIO

83 950,00

95 703,00



● **DAV-T162**

MONOCOMANDO BIDÉ

84 950,00

96 843,00



● **DAV-163**

MONOCOMANDO BASE C/ CHUVEIRO

114 950,00

131 043,00

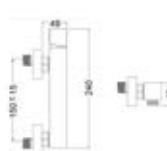

● **DAV-164**

MONOCOMANDO BANHEIRA C/ CHUVEIRO

138 950,00

158 403,00



NOVIDADE



EASY COLLECTION

● **CF-T031** MONOCOMANDO LAVATÓRIO ALTO 162 750,00 **185 535,00**

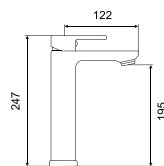

NOVIDADE



● **CF-T030** MONOCOMANDO LAVATÓRIO 99 950,00 **113 943,00**

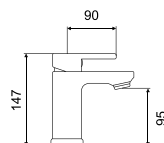

NOVIDADE



● **CF-T033** MONOCOMANDO BIDÉ 102 950,00 **117 363,00**

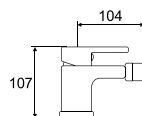

NOVIDADE



● **CF-T032** MONOCOMANDO LAVATÓRIO ENCASTRE 242 950,00 **276 963,00**

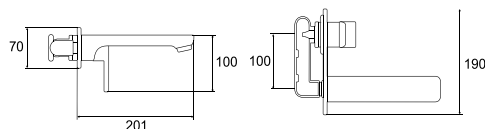

NOVIDADE



● **CF-T034** MONOCOMANDO BASE C/ CHUVEIRO 134 950,00 **153 843,00**

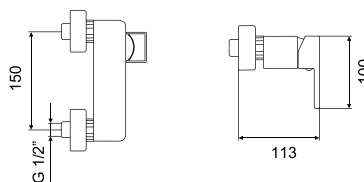

NOVIDADE



● **CF-T035** MONOCOMANDO BANHEIRA C/ CHUVEIRO 184 750,00 **210 615,00**

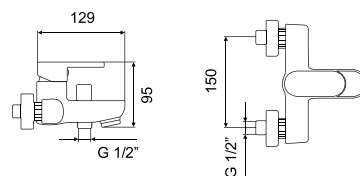



REDONDA COLLECTION



● **DAV-T171**

MONOCOMANDO LAVATÓRIO ALTO

160 750,00

183 255,00

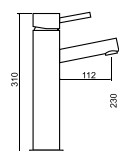

● **DAV-T170**

MONOCOMANDO LAVATÓRIO

80 750,00

92 055,00

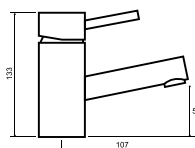

● **DAV-T172**

MONOCOMANDO BIDÉ

80 750,00

92 055,00

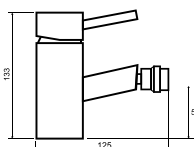

● **DAV-T173**

MONOCOMANDO BASE C/ CHUVEIRO

115 750,00

131 955,00

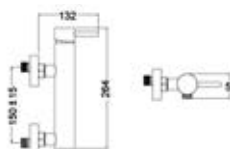

● **DAV-T174**

MONOCOMANDO BANHEIRA C/ CHUVEIRO

142 750,00

162 735,00

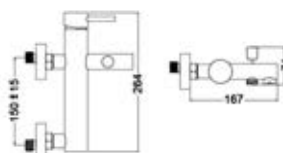



SPIRIT COLLECTION



● **BM-M196**

MONOCOMANDO LAVATÓRIO ALTO

172 950,00

197 163,00

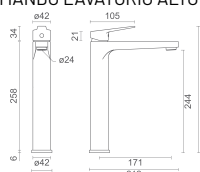

● **BM-M195**

MONOCOMANDO LAVATÓRIO

89 950,00

102 543,00

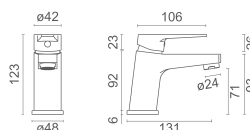

● **BM-M197**

MONOCOMANDO BIDÉ

89 950,00

102 543,00

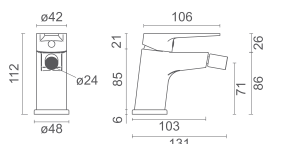

● **BM-M198**

MONOCOMANDO BASE C/ CHUVEIRO

112 950,00

128 763,00

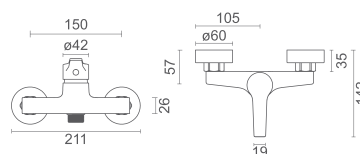

● **BM-M199**

MONOCOMANDO BANHEIRA C/ CHUVEIRO

128 950,00

147 003,00

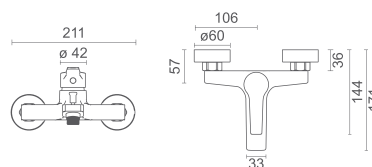



NOVIDADE

IMAGE COLLECTION



● **CF-T050**

MONOCOMANDO LAVATÓRIO

82 750,00

94 335,00

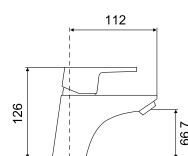

NOVIDADE



● **CF-T051**

MONOCOMANDO BIDÉ

92 750,00

105 735,00

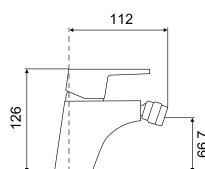

NOVIDADE



● **CF-T052**

MONOCOMANDO BASE C/ CHUVEIRO

117 750,00

134 235,00

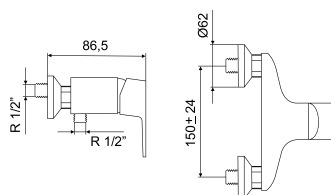

NOVIDADE



● **CF-T053**

MONOCOMANDO BANHEIRA C/ CHUVEIRO

154 750,00

176 415,00

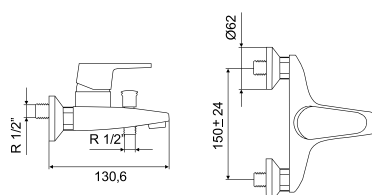

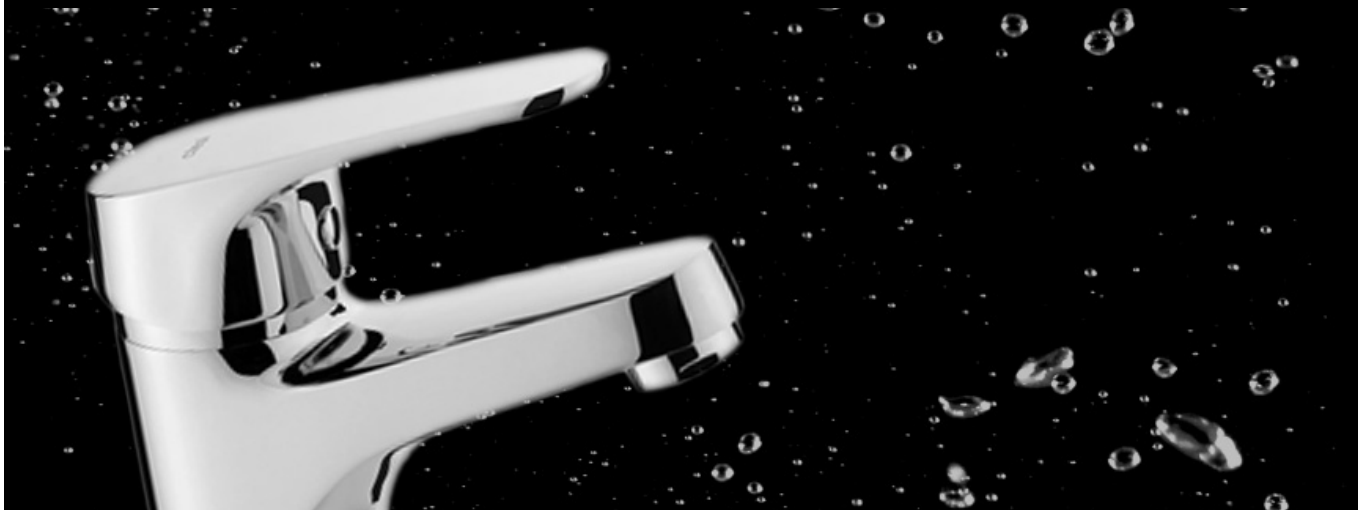

GOAL COLLECTION



● **BM-M070**

MONOCOMANDO LAVATÓRIO

57 750,00

65 835,00

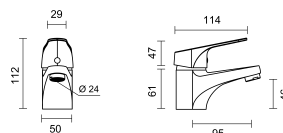

● **BM-M071**

MONOCOMANDO BIDÉ

57 750,00

65 835,00

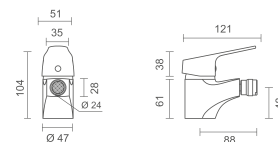

● **BM-M072**

MONOCOMANDO BASE C/ CHUVEIRO

80 750,00

92 055,00

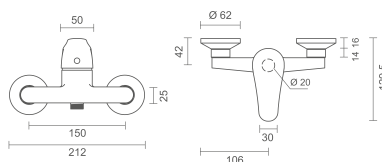

● **BM-M073**

MONOCOMANDO BANHEIRA C/ CHUVEIRO

96 750,00

110 295,00

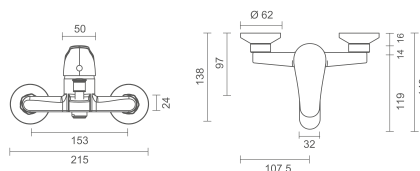



NOVIDADE

NOVA GOLF COLLECTION



CF-T065

MONOCOMANDO LAVATÓRIO

54 750,00

62 415,00

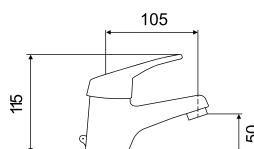

NOVIDADE



CF-T066

MONOCOMANDO BIDÉ

61 750,00

70 395,00

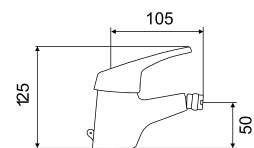

NOVIDADE



CF-T067

MONOCOMANDO BASE C/ CHUVEIRO

87 750,00

100 035,00

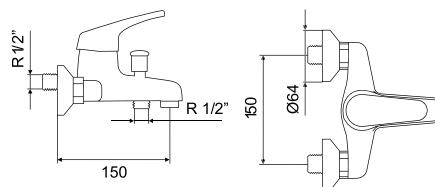

NOVIDADE



CF-T068

MONOCOMANDO BANHEIRA C/ CHUVEIRO

100 750,00

114 855,00

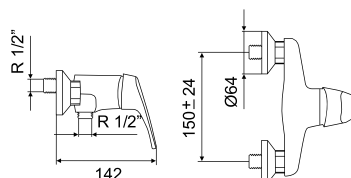



NOVIDADE

FUTURA COLLECTION



● **DAV-T070** MONOCOMANDO LAVATÓRIO 44 750,00 **51 015,00**

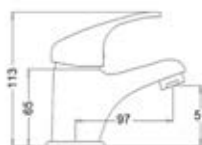

NOVIDADE



● **DAV-T071** MONOCOMANDO BIDÉ 44 750,00 **51 015,00**

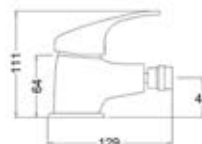

NOVIDADE



● **DAV-T072** MONOCOMANDO BASE C/ CHUVEIRO 59 750,00 **68 115,00**

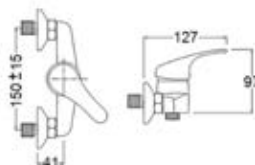

NOVIDADE



● **DAV-T073** MONOCOMANDO BANHEIRA C/ CHUVEIRO 72 750,00 **82 935,00**

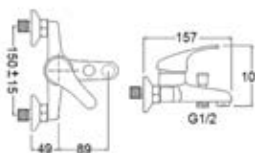



TORNEIRAS ELECTRONICAS

- BM-T110** TORNEIRA ELECTRONICA LAVATÓRIO
1 ÁGUA 252 750,00 **288 135,00**
- BM-T111** TORNEIRA ELECTRONICA LAVATÓRIO
2 ÁGUAS 322 750,00 **367 935,00**

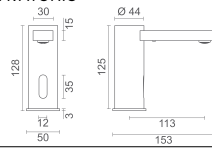

- BM-T113** KEEN TORNEIRA ELECTRONICA URINOL
 INTERIOR 612 750,00 **698 535,00**

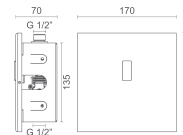

- BM-T112** KEEN TORNEIRA ELECTRONICA URINOL
 EXTERIOR 498 750,00 **568 575,00**

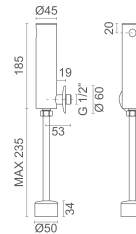

TORNEIRAS TEMPORIZADAS

- BM-T187** LINE TORNEIRA LAVATÓRIO A PAREDE
 TEMPORIZADA EP/1 268 750,00 **306 375,00**

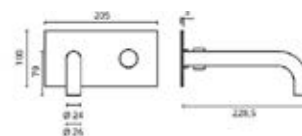

- BM-T188** LINE TORNEIRA LAVATÓRIO TEMPORIZADA
 EP/2 147 750,00 **168 435,00**

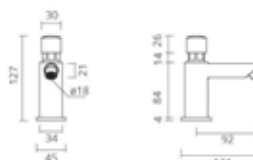

TORNEIRAS TEMPORIZADAS



● **BM-T189**

LINE TORNEIRA LAVATÓRIO TEMPORIZADA EP/3

75 750,00

86 355,00

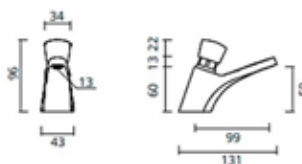

● **BM-T193**

LINE TORNEIRA URINOL EXTERIOR TEMPORIZADA C/ TUBO

118 750,00

135 375,00



● **BM-T194**

TORNEIRA URINOL / BASE INTERIOR TEMPORIZADA

122 750,00

139 935,00

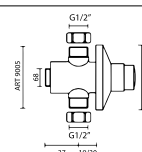

● **BM-T195**

TORNEIRA SANITA INTERIOR TEMPORIZADA

154 750,00

176 415,00

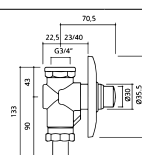

● **BM-T196**

LINE TORNEIRA SANITA EXTERIOR TEMPORIZADA C/ TUBO

242 750,00

276 735,00

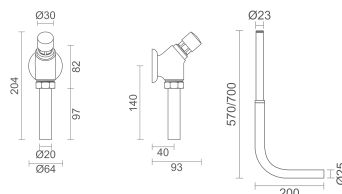

TORNEIRAS SIMPLY

SIMPLY COLLECTION



● **BM-T190**

TORNEIRA DE LAVATÓRIO 1 ÁGUA

92 950,00

105 963,00

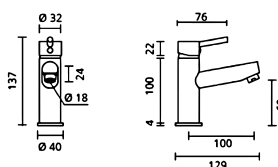

● **BM-T191**

TORNEIRA LAVA LOUÇAS 1 ÁGUA

83 950,00

95 703,00

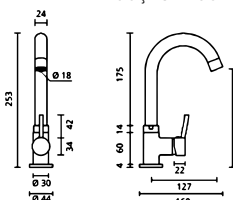



SMOOTH COLLECTION

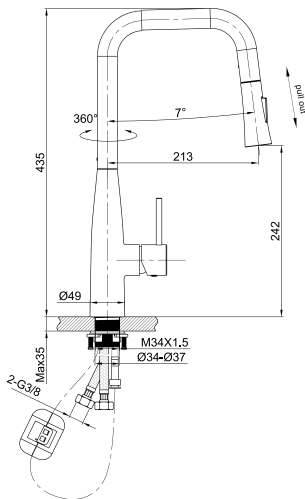

	RB-T199 SMOOTH MONOCOMANDO COZINHA EXTENSIVEL CROMADO	196 250,00	223 725,00
	RB-T199/B SMOOTH MONOCOMANDO COZINHA EXTENSIVEL BRANCO	212 250,00	241 965,00
	RB-T199/P SMOOTH MONOCOMANDO COZINHA EXTENSIVEL PRETO	212 250,00	241 965,00
	RB-T199/D SMOOTH MONOCOMANDO COZINHA EXTENSIVEL DOURADO ESCOVADO	262 250,00	298 965,00
	RB-T199/R SMOOTH MONOCOMANDO COZINHA EXTENSIVEL ROSA GOLD	262 250,00	298 965,00
	RB-T199/G SMOOTH MONOCOMANDO COZINHA EXTENSIVEL GRUN METAL	262 250,00	298 965,00



PLANE PRETA

	BM-CZ20 MONOCOMANDO COZINHA PRETA	220 950,00	251 883,00
--	--	------------	-------------------

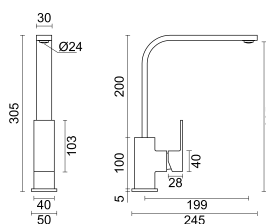

FLEXIVEL COLLECTION



● **BM-CZ11**

KEEN MONOCOMANDO COZINHA C/
FLEXIVEL

296 750,00

338 295,00

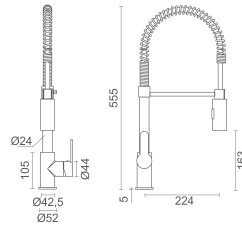

● **DAV-T110**

KEEN MONOCOMANDO COZINHA C/
FLEXIVEL - LED

256 750,00

292 695,00

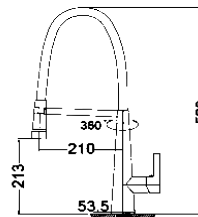

○ **BM-CZ15**

ORION MONOC. COZINHA FLEXIVEL BRANCO

144 750,00

165 015,00

● **BM-CZ15-1**

ORION MONOC. COZINHA FLEXIVEL PRETO

144 750,00

165 015,00

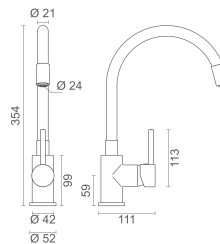

● **BM-CZ12**

KEEN MONOCOMANDO COZINHA C/
CHUVEIRO EXTENSIVEL

224 750,00

256 215,00

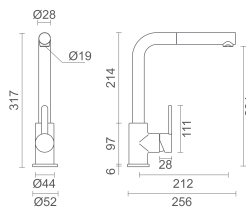

EXTENSIVEL COLLECTION

NOVIDADE



● **DAV-T150**

PRIME MONOCOMANDO COZINHA C/
CHUVEIRO EXTENSIVEL

158 750,00

180 975,00

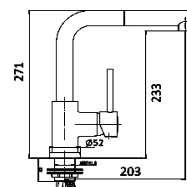

NOVIDADE



BICA ALTA COLLECTION

● **DAV-T031/0**

CILINDRICA MONOCOMANDO COZINHA
DOURADO ESCOBADO

138 750,00

158 175,00

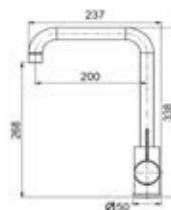

● **DAV-T165**

QUADRADA MONOCOMANDO COZINHA

153 750,00

175 275,00

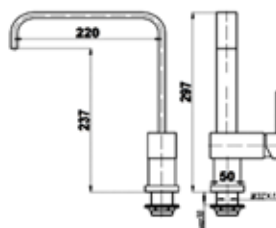

● **DAV-T175**

REDONDA MONOCOMANDO COZINHA

137 750,00

157 035,00



● **BM-CZ16**

ORION MONOCOMANDO COZINHA BICA ALTA

160 750,00

183 255,00

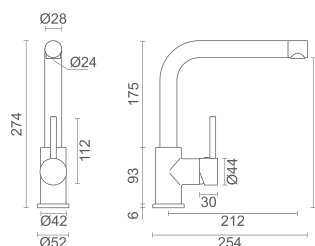

● **DAV-T031**

CILINDRICA MONOCOMANDO COZINHA MC8
002

73 750,00

84 075,00

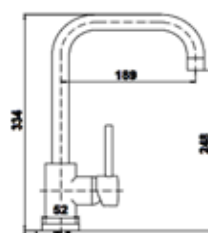

BICA ALTA COLLECTION



DAV-T030

CILINDRICA MONOCOMANDO COZINHA MC8 001

73 750,00

84 075,00

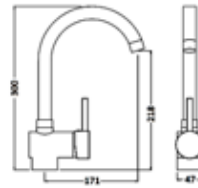

DAV-T055

EKO MONOCOMANDO COZINHA BICA ALTA

54 750,00

62 415,00

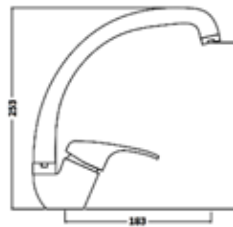

NOVIDADE



DAV-T056

EKO MONOCOMANDO COZINHA BICA BAIXA

41 750,00

47 595,00

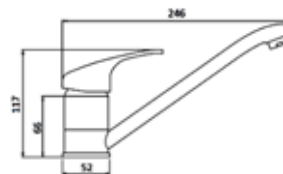

NOVIDADE



DAV-T057

EKO MONOCOMANDO COZINHA A PAREDE

64 750,00

73 815,00

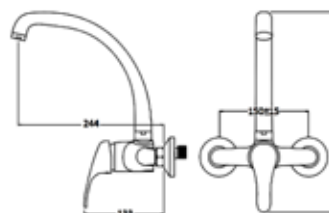



A close-up photograph of a wet orange, showing numerous water droplets on its textured surface. The orange is positioned on the left side of the frame, with the rest of the background being a solid, warm orange color.

dama

SISTEMAS DE DUCHE

ALICIA BLACK



● **RB-CL12-B**

ALICIA COLUNA HIDRO INOX PRETO
1500x230

1 216 750,00

1 387 095,00

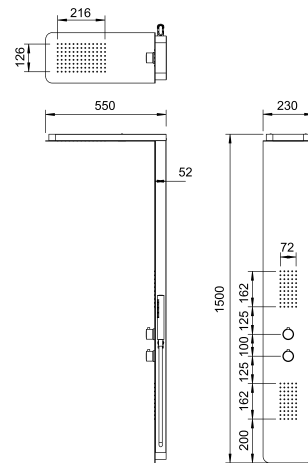

ALICIA WHITE



○ **RB-CL12**

ALICIA COLUNA HIDRO INOX BRANCO
1500x230

1 125 750,00

1 283 355,00

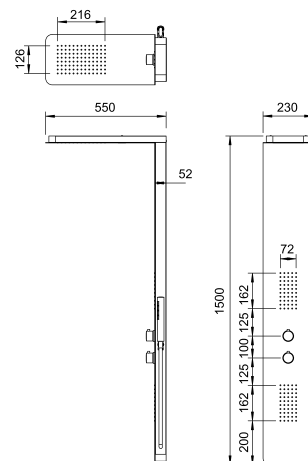

ADA



● **RB-CL10**

ADA COLUNA HIDRO INOX ESCOVADO
1450x200

1 040 750,00

1 186 455,00

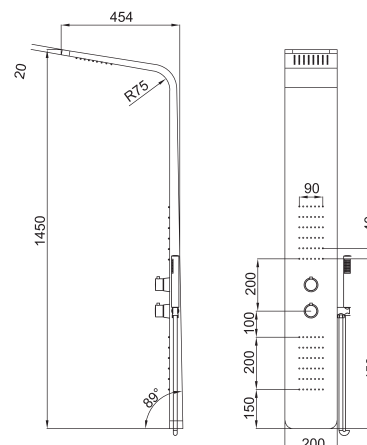

EVA



RB-CL21

EVA COLUNA HIDRO INOX ESCOVADO
1500x200

640 750,00

730 455,00

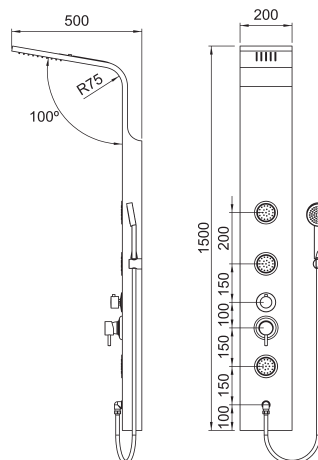

ANA



RB-CL11
ABS

ANA COLUNA HIDRO ANA 1530x200

784 750,00

894 615,00

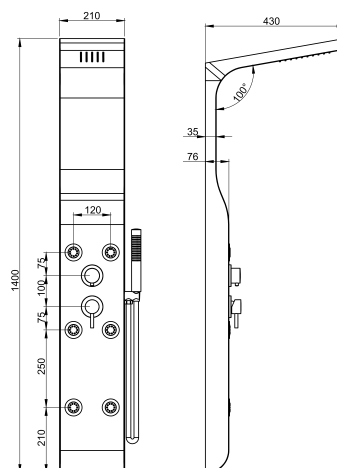

ESTELA



RB-CL20
ABS

ESTELA COLUNA HIDRO 1500x250

592 750,00

675 735,00

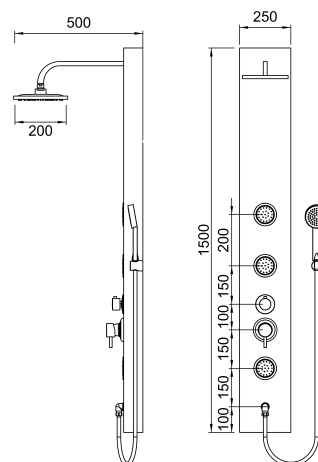



GUN METAL

RB-CL70	GUN METAL COLUNA DUCHE C/ CHUVEIRO	1 488 750,00	1 697 175,00
----------------	------------------------------------	--------------	---------------------

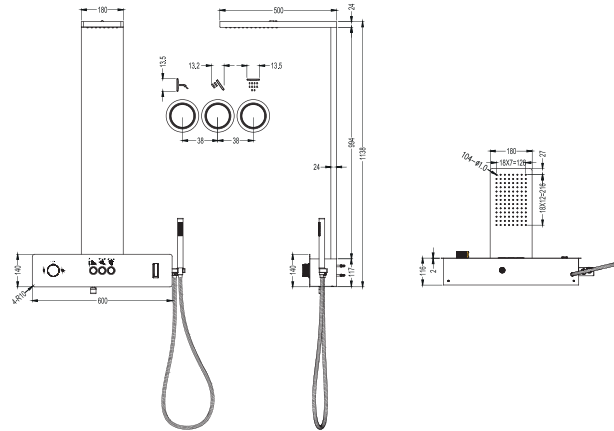

PROMOÇÃO

ENJOY

090.001	ENJOY COLUNA HIDRO	698 750,00	796 575,00
----------------	--------------------	------------	-------------------

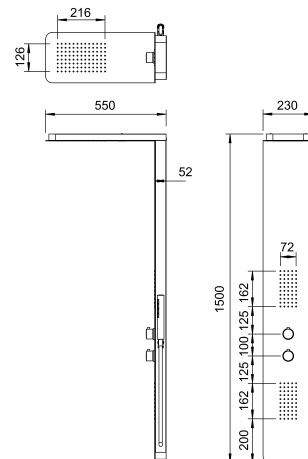

WCA BASE

225.230	WCA COLUNA BANHEIRA C/ CHUVEIRO	588 750,00	671 175,00
230.230	WCA COLUNA BASE C/ CHUVEIRO	588 750,00	671 175,00

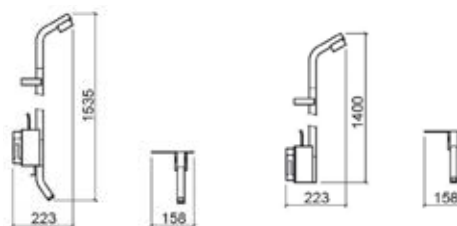

NOVIDADE

SMOOTH COLLECTION

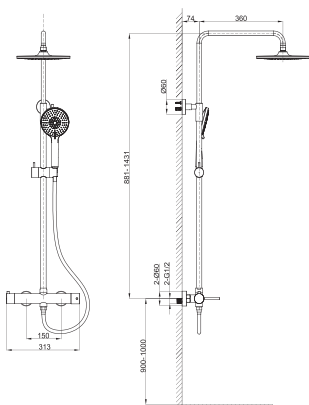

	RB-T196	SMOOTH COLUNA DUCHE C/ CHUVEIRO CROMADO	368 250,00	419 805,00
	RB-T196/B	SMOOTH COLUNA DUCHE C/ CHUVEIRO BRANCO	412 250,00	469 965,00
	RB-T196/P	SMOOTH COLUNA DUCHE C/ CHUVEIRO PRETO	412 250,00	469 965,00
	RB-T196/D	SMOOTH COLUNA DUCHE C/ CHUVEIRO DOURADO ESCOVADO	568 250,00	647 805,00
	RB-T196/R	SMOOTH COLUNA DUCHE C/ CHUVEIRO ROSA GOLD	568 250,00	647 805,00
	RB-T196/G	SMOOTH COLUNA DUCHE C/ CHUVEIRO GUN METAL	568 250,00	647 805,00



REDONDA MR6 / T3M11

	DAV-SD50	MR6 COLUNA DE DUCHE C/ CHUVEIRO	212 750,00	242 535,00
	DAV-SD52	T3M11 COLUNA DE DUCHE C/ CHUVEIRO TERMOSTATICA	258 750,00	294 975,00

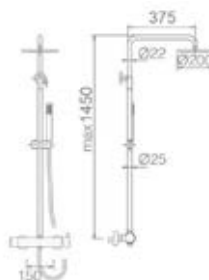

QUADRADA M06 / T3M17

	DAV-SD07	M06 COLUNA DE DUCHE C/ CHUVEIRO	288 750,00	329 175,00
	DAV-SD06	T3M17 COLUNA DE DUCHE C/ CHUVEIRO TERMOSTATICA	338 750,00	386 175,00

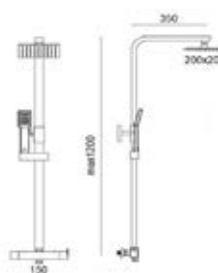



PROMOÇÃO

ROUND MONO SENSE

BM-SD31	ROUND COLUNA DE DUCHE C/ CHUVEIRO CROMADA	368 750,00	420 375,00
----------------	---	------------	-------------------

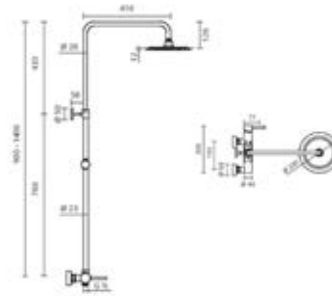

PROMOÇÃO

SQUARE MONO SENSE

BM-SD30	SQUARE COLUNA DE DUCHE C/ CHUVEIRO CROMADA	388 750,00	443 175,00
----------------	--	------------	-------------------

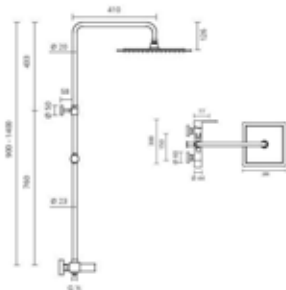

PROMOÇÃO

ROUND MONO SENSE / TERMO SENSE

BM-SD31-1	MONO SENSE COLUNA DE DUCHE C/ CHUVEIRO PRETO	368 750,00	420 375,00
BM-SD31-2	TERMO SENSE COLUNA DE DUCHE C/ CHUVEIRO TERMOSTATICO PRETA	398 750,00	454 575,00



REDONDA MR6 PRETA

DAV-SD51	MR6 COLUNA DE DUCHE C/ CHUVEIRO PRETA	298 950,00	340 803,00
-----------------	---------------------------------------	------------	-------------------

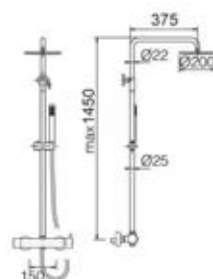



STYLE 25 COLLECTION

● CF-T199/C	COLUNA DE DUCHE CROMADO	508 750,00	579 975,00
● CF-T199/P	COLUNA DE DUCHE PRETO	654 750,00	746 415,00
● CF-T199/O	COLUNA DE DUCHE OURO	1154 750,00	1316 415,00

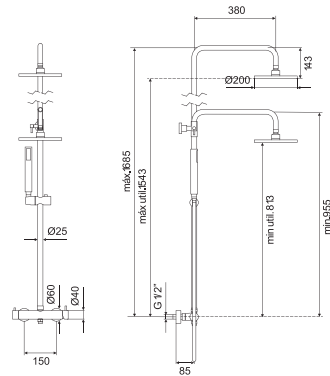

MARGARIDA INOX

● RB-CH20	CHUVEIRO EXTERIOR AO CHÃO CROMADO	1680 750,00	1916 055,00
------------------	-----------------------------------	-------------	--------------------

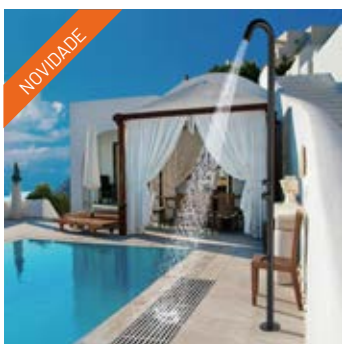

MARGARIDA INOX PRETO

● RB-CH20-P	CHUVEIRO EXTERIOR AO CHÃO PRETO	1898 750,00	2164 575,00
--------------------	---------------------------------	-------------	--------------------





COMPLETA SE019

SD-400

SE019 RAMPA CHUVEIRO COMPLETA

115 750,00

131 955,00

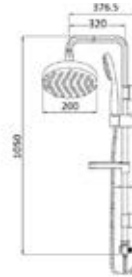

SQUARE / ROUND

SD-398

SQUARE RAMPA DE CHUVEIRO QUADRADA

238 750,00

272 175,00

SD-399

ROUND RAMPA DE CHUVEIRO REDONDA

238 750,00

272 175,00

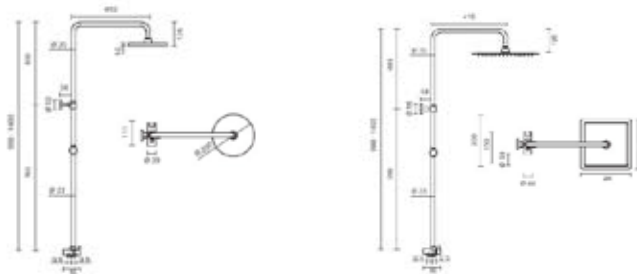

NAU C/ SABONETEIRA

SD-401

NAU RAMPA CHUVEIRO C/ SABONETEIRA

18 750,00

21 375,00



PRESTIGE

SD-402

PRESTIGE RAMPA CHUVEIRO

12 750,00

14 535,00

NOVIDADE

SMOOTH COLLECTION

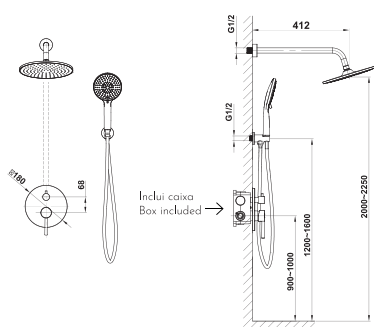

	RB-T197 SMOOTH CONJUNTO ENCASTRE 2 VIAS CROMADO	358 250,00	408 405,00
	RB-T197/B SMOOTH CONJUNTO ENCASTRE 2 VIAS BRANCO	358 250,00	408 405,00
	RB-T197/P SMOOTH CONJUNTO ENCASTRE 2 VIAS PRETO	358 250,00	408 405,00
	RB-T197/D SMOOTH CONJUNTO ENCASTRE 2 VIAS DOURADO ESCOV.	412 250,00	469 965,00
	RB-T197/R SMOOTH CONJUNTO ENCASTRE 2 VIAS ROSA GOLD	412 250,00	469 965,00
	RB-T197/G SMOOTH CONJUNTO ENCASTRE 2 VIAS GUN METAL	412 250,00	469 965,00

NOVIDADE

KNOBE



	BM-M117/O KNOBE CONJUNTO DE DUCHE ENCASTRE 2 VIAS OURO BRILHO	898 750,00	1 024 575,00
--	--	------------	---------------------

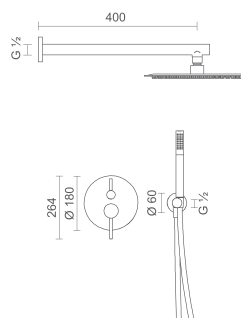

SLIM



	DAV-SD10 SLIM CONJUNTO DE DUCHE ENCASTRE 2 VIAS CROMADO	224 750,00	256 215,00
	DAV-SD10-1 SLIM CONJUNTO DE DUCHE ENCASTRE 2 VIAS PRETO	346 750,00	395 295,00

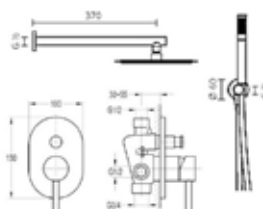



COMPLETEA SE019

● **SD-500** FASHION SISTEMA DE DUCHE 2/3VIAS 760 750,00 **867 255,00**



STYLE 25

● **CF-T196** STYLE 25 MONOC. ENCASTRAR 1 VIA 129 950,00 **148 143,00**

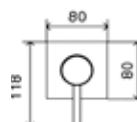

● **CF-T197** STYLE 25 MONOC. ENCASTRAR 2 VIAS 223 950,00 **255 303,00**

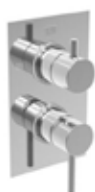
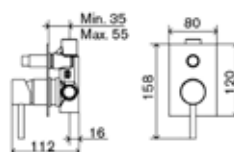

● **CF-T198** STYLE 25 MONOC. ENCASTRAR 3 VIAS 271 950,00 **310 023,00**

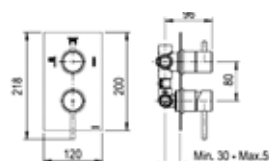

NOVIDADE



EASY

● **CF-T036** EASY MONOC. ENCASTRAR 1 VIA 129 750,00 **147 915,00**



NOVIDADE



● **CF-T037** EASY MONOC. ENCASTRAR 2 VIAS 182 750,00 **208 335,00**

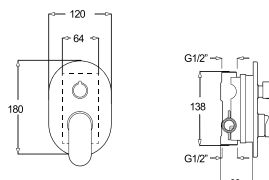

SLIM

● **DAV-SD05** MONOC. ENCASTRAR 2 VIAS CROMADO TE202 132 750,00 **151 335,00**

● **DAV-SD05/P** MONOC. ENCASTRAR 2 VIAS PRETO TE2002 188 750,00 **215 175,00**





PRESTIGE Nº1

SD-230

PRESTIGE Nº1 CHUVEIRO DE TETO
QUADRADO 3 FUNÇÕES 60x60

1 888 750,00

2 153 175,00

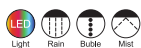
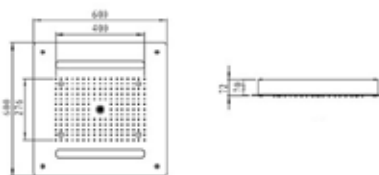

PRESTIGE Nº2

SD-231

PRESTIGE Nº2 CHUVEIRO DE TETO
REDONDO 3 FUNÇÕES 50

1 440 750,00

1 642 455,00

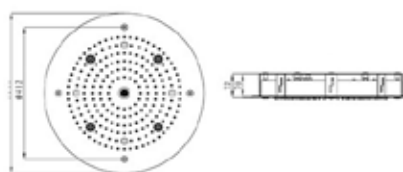

PRESTIGE Nº3

SD-232

PRESTIGE Nº3 CHUVEIRO DE TETO
QUADRADO 2 FUNÇÕES 50x50

548 750,00

625 575,00

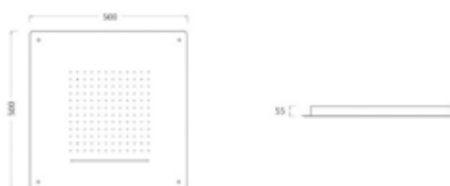

PRESTIGE Nº4

SD-233

PRESTIGE Nº4 CHUVEIRO DE TETO
QUADRADO 40x40

248 750,00

283 575,00

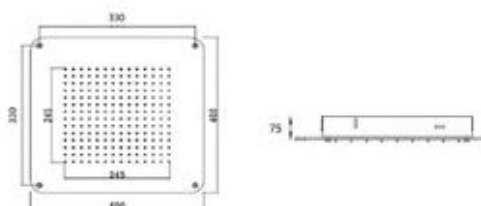

CHUVEIROS DE PAREDE



FASHION

SD-220

FASHION CHUVEIRO A PAREDE 2 FUNÇÕES
50x23

632 750,00

721 335,00

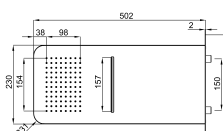

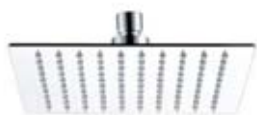

QUADRADO

SD-200	CHUVEIRO QUADRADO 200 MM ABS	29 750,00	33 915,00
SD-201	CHUVEIRO QUADRADO 230 MM INOX	52 950,00	60 363,00
SD-202	CHUVEIRO QUADRADO 300 MM INOX	70 750,00	80 655,00



REDONDO

SD-205	CHUVEIRO REDONDO 200 MM ABS	28 750,00	32 775,00
SD-206	CHUVEIRO REDONDO 230 MM INOX	49 750,00	56 715,00
SD-207	CHUVEIRO REDONDO 300 MM INOX	62 750,00	71 535,00

NOVIDADE



SD-206/P	REDONDO CHUVEIRO INOX PRETO ø230 mm	68 750,00	78 375,00
-----------------	-------------------------------------	-----------	------------------



BRAÇOS DE CHUVEIRO

SD-150 LATÃO	QUADRADO BRAÇO CHUVEIRO	44 750,00	51 015,00
-------------------------	-------------------------	-----------	------------------



SD-152	REDONDO BRAÇO CHUVEIRO	25 750,00	29 355,00
---------------	------------------------	-----------	------------------

SD-152/P	REDONDO BRAÇO CHUVEIRO	34 750,00	39 615,00
-----------------	------------------------	-----------	------------------



SD-151	QUADRADO BRAÇO CHUVEIRO A TETO	35 750,00	40 755,00
---------------	--------------------------------	-----------	------------------



SD-153	REDONDO BRAÇO CHUVEIRO A TETO	17 750,00	20 235,00
---------------	-------------------------------	-----------	------------------

SD-153/P	REDONDO BRAÇO CHUVEIRO A TETO	22 750,00	25 935,00
-----------------	-------------------------------	-----------	------------------





PROMOÇÃO

BETA

SD-210	BETA CHUVEIRO DE MÃO 3 FUNÇÕES	18 950,00	21 603,00
---------------	--------------------------------	-----------	------------------

NOVIDADE

**DAMA**

SD-210-1	DAMA CHUVEIRO DE MÃO 5 FUNÇÕES	11 750,00	13 395,00
-----------------	--------------------------------	-----------	------------------

**EKO**

SD-213	EKO CHUVEIRO DE MÃO 1 FUNÇÕES	19 750,00	22 515,00
SD-213-2	EKO CHUVEIRO DE MÃO 3 FUNÇÃO	22 750,00	25 935,00

**QUADRADO**

SD-214	QUADRADO CHUVEIRO DE MÃO 1 FUNÇÃO	7 750,00	8 835,00
---------------	-----------------------------------	----------	-----------------

**REDONDO**

<input type="radio"/> SD-215	REDONDO CHUVEIRO DE MÃO 1 FUNÇÃO	7 750,00	8 835,00
<input checked="" type="radio"/> SD-215/P	REDONDO CHUVEIRO DE MÃO 1 FUNÇÃO	9 750,00	11 115,00

**REDONDO**

<input type="radio"/> SD-510	QUADRADO SUPORTE CHUVEIRO - ABS	7 250,00	8 265,00
<input type="radio"/> SD-512	REDONDO SUPORTE CHUVEIRO - ABS	5 250,00	5 985,00
<input checked="" type="radio"/> SD-512/P	REDONDO SUPORTE CHUVEIRO - ABS PRETO	7 250,00	8 265,00



<input type="radio"/> SD-511	QUADRADO SUPORTE CHUVEIRO C/ TOMADA ÁGUA	24 750,00	28 215,00
<input type="radio"/> SD-513	REDONDO SUPORTE CHUVEIRO C/ TOMADA ÁGUA	26 750,00	30 495,00
<input checked="" type="radio"/> SD-513/P	REDONDO SUPORTE CHUVEIRO C/ TOMADA ÁGUA	26 750,00	30 495,00

**BICHAS**

<input type="radio"/> SD-110	BICHA CHUVEIRO ARGOLAS 120 cm	5 750,00	6 555,00
<input type="radio"/> SD-111	BICHA CHUVEIRO ARGOLAS 170 cm	6 750,00	7 695,00
<input type="radio"/> SD-112	DUO BICHA CHUVEIRO 170 cm	14 750,00	16 815,00
<input checked="" type="radio"/> SD-112/P	BICHA CHUVEIRO ARGOLAS 170 cm	18 750,00	21 375,00



dama

ACESSÓRIOS DE BANHO

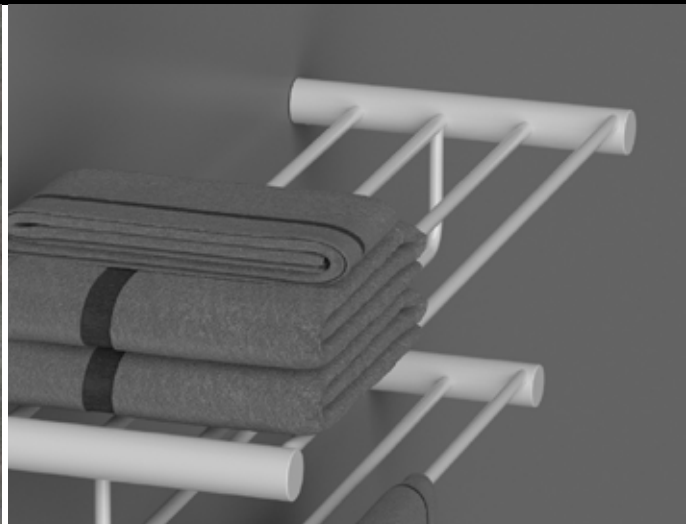
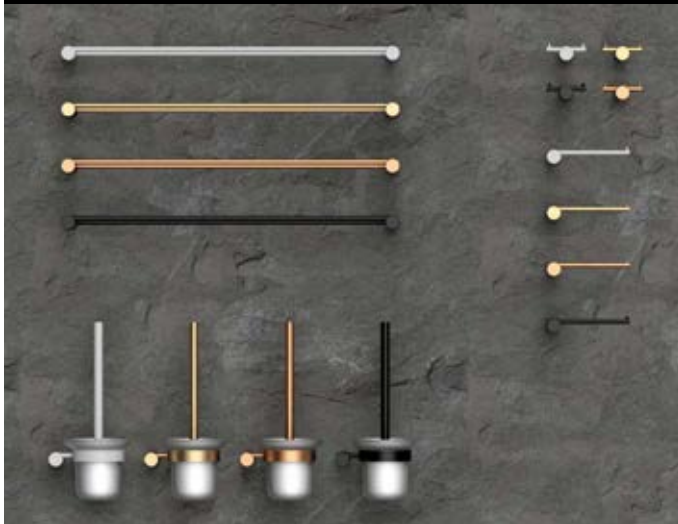

SMOOTH COLLECTION

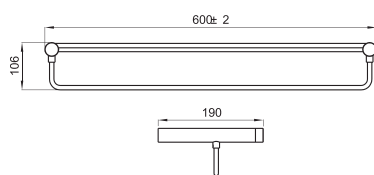

	RB-AC190	TOALHEIRO C/ PARTELEIRA CROMADO	128 750,00	146 775,00
	RB-AC190/B	TOALHEIRO C/ PARTELEIRA BRANCO	160 750,00	183 255,00
	RB-AC190/P	TOALHEIRO C/ PARTELEIRA PRETO	160 750,00	183 255,00
	RB-AC190/D	TOALHEIRO C/ PARTELEIRA DOURADO ESCOVADO	176 750,00	201 495,00
	RB-AC190/R	TOALHEIRO C/ PARTELEIRA ROSA GOLD	176 750,00	201 495,00
	RB-AC190/G	TOALHEIRO C/ PARTELEIRA GUN METAL	176 750,00	201 495,00

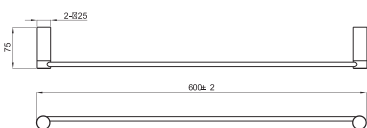

	RB-AC191	TOALHEIRO BARRA 60 cm CROMADO	56 750,00	64 695,00
	RB-AC191/B	TOALHEIRO BARRA 60 cm BRANCO	56 750,00	64 695,00
	RB-AC191/P	TOALHEIRO BARRA 60 cm PRETO	56 750,00	64 695,00
	RB-AC191/D	TOALHEIRO BARRA 60 cm DOURADO ESCOVADO	64 750,00	73 815,00
	RB-AC191/R	TOALHEIRO BARRA 60 cm ROSA GOLD	64 750,00	73 815,00
	RB-AC191/G	TOALHEIRO BARRA 60 cm GUN METAL	64 750,00	73 815,00

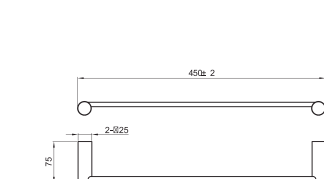

	RB-AC192	TOALHEIRO BARRA 45 cm CROMADO	52 950,00	60 363,00
	RB-AC192/B	TOALHEIRO BARRA 45 cm BRANCO	52 950,00	60 363,00
	RB-AC192/P	TOALHEIRO BARRA 45 cm PRETO	52 950,00	60 363,00
	RB-AC192/D	TOALHEIRO BARRA 45 cm DOURADO ESCOVADO	60 950,00	69 483,00
	RB-AC192/R	TOALHEIRO BARRA 45 cm ROSA GOLD	60 950,00	69 483,00
	RB-AC192/G	TOALHEIRO BARRA 45 cm GUN METAL	60 950,00	69 483,00

SMOOTH COLLECTION

NOVIDADE

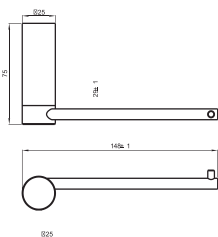

	RB-AC193	PORTA ROLOS CROMADO	40 750,00	46 455,00
	RB-AC193/B	PORTA ROLOS BRANCO	40 750,00	46 455,00
	RB-AC193/P	PORTA ROLOS PRETO	40 750,00	46 455,00
	RB-AC193/D	PORTA ROLOS DOURADO ESCOVADO	48 750,00	55 575,00
	RB-AC193/R	PORTA ROLOS ROSA GOLD	48 750,00	55 575,00
	RB-AC193/G	PORTA ROLOS GUN METAL	48 750,00	55 575,00

NOVIDADE

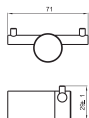

	RB-AC194	CABIDE CROMADO	32 750,00	37 335,00
	RB-AC194/B	CABIDE BRANCO	32 750,00	37 335,00
	RB-AC194/P	CABIDE PRETO	32 750,00	37 335,00
	RB-AC194/D	CABIDE DOURADO ESCOVADO	40 750,00	46 455,00
	RB-AC194/R	CABIDE ROSA GOLD	40 750,00	46 455,00
	RB-AC194/G	CABIDE GUN METAL	40 750,00	46 455,00

NOVIDADE

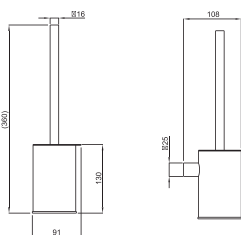

	RB-AC195	PORTA PIAÇABA CROMADO	48 750,00	55 575,00
	RB-AC195/B	PORTA PIAÇABA BRANCO	56 750,00	64 695,00
	RB-AC195/P	PORTA PIAÇABA PRETO	56 750,00	64 695,00
	RB-AC195/D	PORTA PIAÇABA DOURADO COVADO	64 750,00	73 815,00
	RB-AC195/R	PORTA PIAÇABA ROSA GOLD	64 750,00	73 815,00
	RB-AC195/G	PORTA PIAÇABA GUN METAL	64 750,00	73 815,00



PIXEL COLLECTION



● **BM-AC170**

PIXEL TOALHEIRO BARRA 60 cm

83 750,00

95 475,00



● **BM-AC171**

PIXEL TOALHEIRO BARRA 45 cm

80 750,00

92 055,00

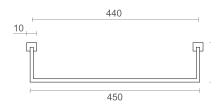

● **BM-AC172**

PIXEL PORTA ROLOS

80 750,00

92 055,00

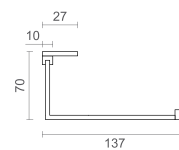

● **BM-AC173**

PIXEL CABIDE

41 750,00

47 595,00

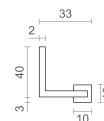

● **BM-AC174**

PIXEL PORTA PIAÇABA

134 750,00

153 615,00

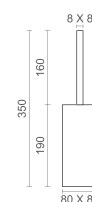



PIXEL COLLECTION



BM-AC164/B PIPELINE TOALHEIRO BARRA 60 cm 281 750,00 **321 195,00**



BM-AC165/B PIPELINE TOALHEIRO BARRA 45 cm 205 750,00 **234 555,00**



BM-AC166/B PIPELINE PORTA ROLOS 121 750,00 **138 795,00**

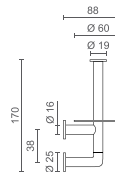

BM-AC167/B PIPELINE CABIDE 76 750,00 **87 495,00**

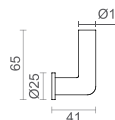

BM-AC168/B PIPELINE PORTA PIAÇABA 313 750,00 **357 675,00**

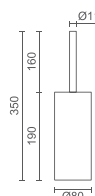



NOVIDADE



STRAIGHT COLLECTION

	CF-AC81	STRAIGHT TOALHEIRO BANHEIRA 64 cm	272 950,00	311 163,00
	CF-AC81/O	STRAIGHT TOALHEIRO BANHEIRA 64 cm	497 950,00	567 663,00
	CF-AC81/P	STRAIGHT TOALHEIRO BANHEIRA 64 cm	327 950,00	373 863,00

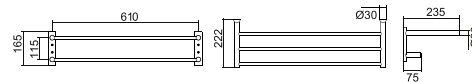

	CF-AC82	STRAIGHT TOALHEIRO BARRA 60 cm	65 950,00	311 163,00
	CF-AC82/O	STRAIGHT TOALHEIRO BARRA 60 cm	87 950,00	567 663,00
	CF-AC82/P	STRAIGHT TOALHEIRO BARRA 60 cm	85 950,00	373 863,00

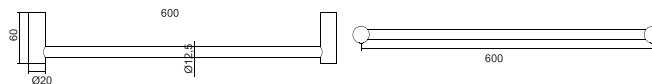

	CF-AC83	STRAIGHT TOALHEIRO BARRA 45 cm	57 950,00	66 063,00
	CF-AC83/O	STRAIGHT TOALHEIRO BARRA 45 cm	83 950,00	95 703,00
	CF-AC83/P	STRAIGHT TOALHEIRO BARRA 45 cm	63 950,00	72 903,00

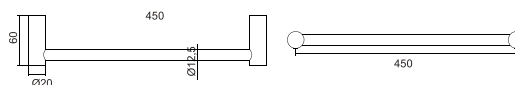

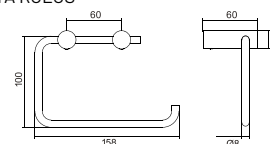

	CF-AC84	STRAIGHT PORTA ROLOS	49 950,00	56 943,00
	CF-AC84/O	STRAIGHT PORTA ROLOS	75 950,00	86 583,00
	CF-AC84/P	STRAIGHT PORTA ROLOS	59 950,00	68 343,00



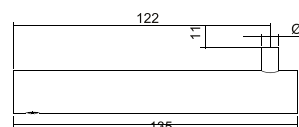

	CF-AC85	STRAIGHT PORTA ROLOS SIMPLE	35 950,00	40 983,00
	CF-AC85/O	STRAIGHT PORTA ROLOS SIMPLE	53 950,00	61 503,00
	CF-AC85/P	STRAIGHT PORTA ROLOS SIMPLE	39 950,00	45 543,00





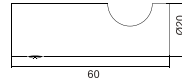



	CF-AC86	STRAIGHT CABIDE	17 950,00	20 463,00
	CF-AC86/O	STRAIGHT CABIDE	26 950,00	30 723,00
	CF-AC86/P	STRAIGHT CABIDE	18 950,00	21 603,00

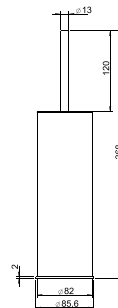



	CF-AC87	STRAIGHT PORTA PIAÇABA	177 950,00	202 863,00
	CF-AC87/O	STRAIGHT PORTA PIAÇABA	239 950,00	273 543,00
	CF-AC87/P	STRAIGHT PORTA PIAÇABA	212 950,00	242 763,00

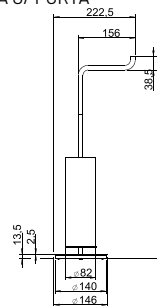

	CF-AC88	STRAIGHT PORTA PIAÇABA C/ PORTA ROLOS	290 950,00	331 683,00
	CF-AC88/O	STRAIGHT PORTA PIAÇABA C/ PORTA ROLOS	447 950,00	510 663,00
	CF-AC88/P	STRAIGHT PORTA PIAÇABA C/ PORTA ROLOS	378 950,00	432 003,00



	CF-AC89	STRAIGHT TOALHEIRO DE PÉ	380 950,00	434 283,00
	CF-AC89/O	STRAIGHT TOALHEIRO DE PÉ	513 950,00	585 903,00
	CF-AC89/P	STRAIGHT TOALHEIRO DE PÉ	456 950,00	520 923,00

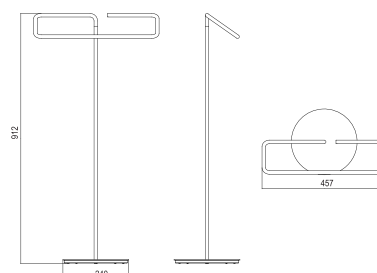



PROMOÇÃO

NEXUS COLLECTION

	BM-AC140/O	NEXUS TOALHEIRO BARRA 60cm	108 750,00	123 975,00
	BM-AC141/O	NEXUS TOALHEIRO BARRA 45 cm	94 750,00	108 015,00



PROMOÇÃO

	BM-AC142/O	NEXUS PORTA ROLOS	94 750,00	108 015,00
--	-------------------	-------------------	-----------	-------------------



PROMOÇÃO

	BM-AC143/O	NEXUS CABIDE	51 750,00	58 995,00
--	-------------------	--------------	-----------	------------------



PROMOÇÃO

	BM-AC144/O	NEXUS PORTA PIAÇABA	243 750,00	277 875,00
--	-------------------	---------------------	------------	-------------------



SLIM COLLECTION

	IT-AC60	SLIM CABIDE PRETO	27 750,00	31 635,00
--	----------------	-------------------	-----------	------------------



	IT-AC61	SLIM PORTA ROLOS PRETO	40 750,00	46 455,00
--	----------------	------------------------	-----------	------------------



	IT-AC62	SLIM TOALHEIRO 30 CM PRETO	50 750,00	57 855,00
--	----------------	----------------------------	-----------	------------------

	IT-AC63	SLIM TOALHEIRO 50 CM PRETO	64 750,00	73 815,00
--	----------------	----------------------------	-----------	------------------



	IT-AC64	SLIM TOALHEIRO DUPLO 50 CM PRETO	88 750,00	101 175,00
--	----------------	----------------------------------	-----------	-------------------



	IT-AC65	SLIM TOALHEIRO BANHEIRA 50 CM PRETO	144 750,00	165 015,00
--	----------------	-------------------------------------	------------	-------------------



	IT-AC66	SLIM TOALHEIRO PÉ PRETO	320 750,00	365 655,00
--	----------------	-------------------------	------------	-------------------



OCEAN

AC-KT03

OCEAN KIT TOALHEIROS 5 PÇ
FORNECIDO EM CAIXA

83 750,00

95 475,00



MAXI COLLECTION

AC-KT02

MAXI KIT TOALHEIROS 6 PÇ
FORNECIDO EM CAIXA

153 750,00

175 275,00



LIBERTY COLLECTION

AC-KT01

LIBERTY KIT TOALHEIROS 6 PÇ
FORNECIDO EM CAIXA

168 750,00

192 375,00



AC-KT01-1

LIBERTY CABIDE

20 750,00

23 655,00



AC-KT01-2

LIBERTY PORTA ROLOS C/ TAMPA

36 750,00

41 895,00



AC-KT01-3

LIBERTY TOALHEIRO ARGOLA

28 750,00

32 775,00



AC-KT01-4

LIBERTY TOALHEIRO BARRA 45 cm

38 750,00

44 175,00

















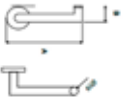

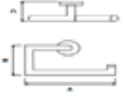

AC-KT01-5

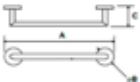
LIBERTY TOALHEIRO BARRA 60 cm

40 750,00

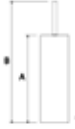
46 455,00

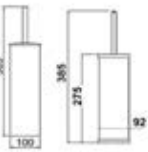
HOTEL / ACESSÓRIOS

	HT-AC28	HOTEL CABIDE		Dimensões A x B x C (mm) Dimensões A x B x C (mm) 53,5 x 53,5 x 55	12 950,00	14 763,00
 PROMOÇÃO	HT-AC75	HOTEL PORTA ROELoS C/ TAMPA			51 950,00	59 223,00
	HT-AC74	HOTEL PORTA ROELoS		Dimensões A x B (mm) Dimensões A x B (mm) 177 x 70	20 950,00	23 883,00
	HT-AC76	HOTEL PORTA ROELoS RESERVA		Dimensões A x B (mm) 185 x 85	28 950,00	33 003,00
	HT-AC97	HOTEL TOALHEIRO BIDÉ		Dimensões A x B x C (mm) 210 x 110 x 69,5	40 950,00	46 683,00
	HT-AC96	HOTEL TOALHEIRO BARRA 60 cm		Dimensões A x B x C (mm) 501 x 54	40 950,00	46 683,00
	HT-AC95	HOTEL TOALHEIRO BANHEIRA		Dimensões A x B x C (mm) 522 x 150 x 228	96 950,00	110 523,00
	HT-AC72	HOTEL PORTA PIAÇABA LATÃO BRILHO			43 750,00	49 875,00
	HT-AC73	HOTEL PORTA PIAÇABA LATÃO ESCOVADO			43 750,00	49 875,00
	DAV-AC20	ECO PORTA PIAÇABA QUADRADO			10 250,00	11 685,00
	DAV-AC21	ECO PORTA PIAÇABA REDONDO			9 250,00	10 545,00



HOTEL / SABONETEIRAS

HT-AC80 HOTEL SABONETEIRA 64 750,00 **73 815,00**



HT-AC81 HOTEL SABONETEIRA CANTO 62 750,00 **71 535,00**



HOTEL / ESPELHOS

HT-AC40 HOTEL ESPELHO C/ AUMENTO POUSAR 54 750,00 **62 415,00**
HT-AC41 HOTEL ESPELHO C/ AUMENTO POUSAR 54 750,00 **62 415,00**

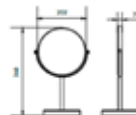

HT-AC42 HOTEL ESPELHO C/ AUMENTO A PAREDE 67 750,00 **77 235,00**

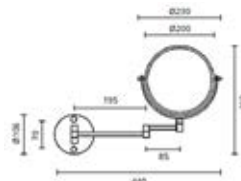

HOTEL / BALDES

HT-AC18-1 HOTEL BALDE REDONDO C/ SOFT CLOSE 3 LT 44 950,00 **51 243,00**
HT-AC18-2 HOTEL BALDE REDONDO C/ SOFT CLOSE 5 LT 51 950,00 **59 223,00**
HT-AC18-3 HOTEL BALDE REDONDO C/ SOFT CLOSE 12 LT 73 950,00 **84 303,00**

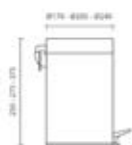

HT-AC15 HOTEL BALDE REDONDO 3 LT 13 950,00 **15 903,00**
HT-AC16 HOTEL BALDE REDONDO 5 LT 17 950,00 **20 463,00**
HT-AC17 HOTEL BALDE REDONDO 12 LT 30 950,00 **35 283,00**

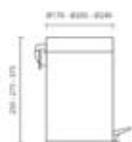

HT-AC10 HOTEL BALDE QUADRADO 3 LT 22 950,00 **26 163,00**
HT-AC11 HOTEL BALDE QUADRADO 5 LT 28 950,00 **33 003,00**
HT-AC12 HOTEL BALDE QUADRADO 12 LT 44 950,00 **51 243,00**

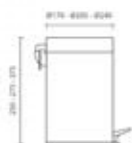



PROMOÇÃO

HOTEL / BALDES

HT-AC20

HOTEL BALDE / PAPELEIRA 25 LT INOX

148 950,00

169 803,00

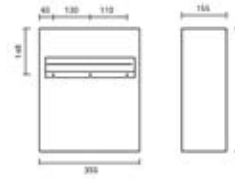

HOTEL / SECADORES

HT-AC93

HOTEL SECADOR DE MÃOS HD1800 INOX ESCOVADO

384 750,00

438 615,00

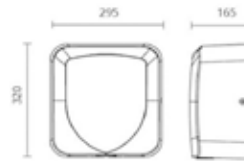

HT-AC92

HOTEL SECADOR DE MÃOS WIND ABS BRANCO

1 280 750,00

1 460 055,00

HT-AC92-1

HOTEL SECADOR DE MÃOS WIND ABS PRATEADO

1 280 750,00

1 460 055,00

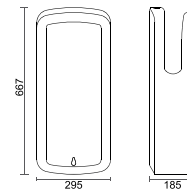

PROMOÇÃO

HT-AC90

HOTEL SECADOR CABELO

76 950,00

87 723,00



HOTEL / DISPENSADORES DE PAPEL



HT-AC50

HOTEL DISPENSADOR DE PAPEL HIGIÊNICO INOX ESCOVADO

96 750,00

110 295,00

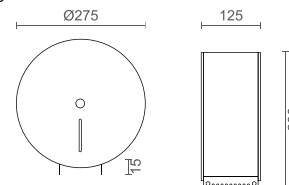

HT-AC50-1

HOTEL DISPENSADOR DE PAPEL HIGIÊNICO ABS

35 750,00

40 755,00

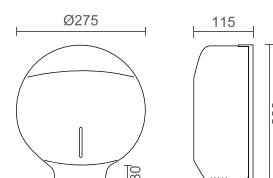



HOTEL / DISPENSADORES DE PAPEL

HT-AC51

HOTEL DISPENSADOR DE TOALHAS INOX ESCOVADO

108 950,00

124 203,00

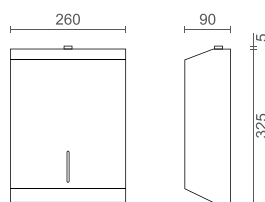

HT-AC51-1

HOTEL DISPENSADOR DE TOALHAS ABS

40 250,00

45 885,00

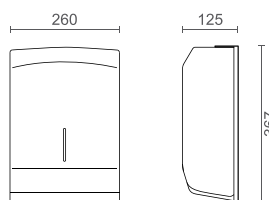

HOTEL / DOSEADORES DE SABONETE

HT-AC55

HOTEL DOSEADOR SABONETE INOX ESCOVADO

72 250,00

82 365,00

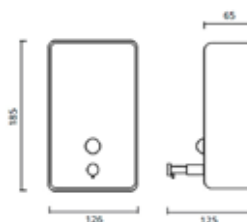

HT-AC55-1

HOTEL DOSEADOR SABONETE ABS

12 250,00

13 965,00



HOTEL / ESTANDAL



HT-AC43

HOTEL ESTANDAL

48 250,00

55 005,00







d!ama

LAVA-LOUÇAS

FLOW C/ ACESSÓRIOS



BK-EG10

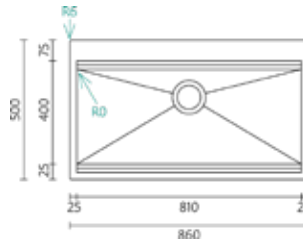

1525 250,00

1738 785,00



CARAVELA



BK-EG20

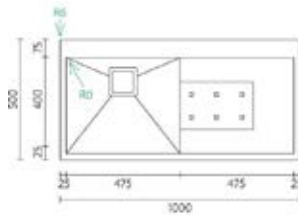

1305 250,00

1487 985,00



BOLD 34-34



BK-BD20

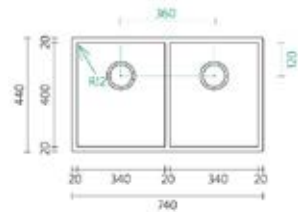

1084 750,00

1236 615,00



BOLD 74



BK-BD30

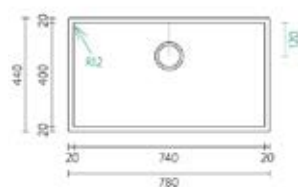

558 750,00

636 975,00



BOLD 50



BK-BD40

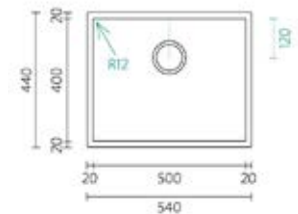

456 750,00

520 695,00



BRAGA 100 VIDRO WHITE



170.100

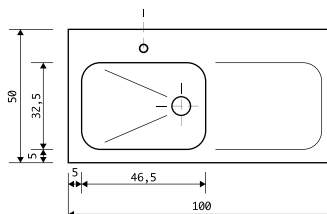

498 950,00

568 803,00





ELEMENT 116

BK-EL10

429 950,00

490 143,00

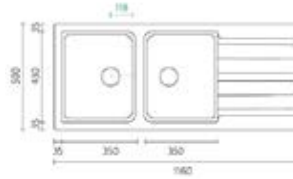

PROMOÇÃO

ELEMENT 100

BK-EL11

395 950,00

451 383,00

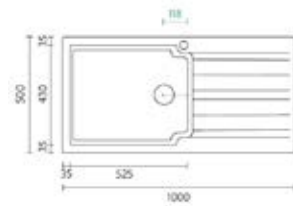

ELEMENT 86

BK-EL12

378 950,00

432 003,00

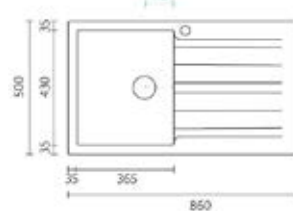

BALANCE 120

BK-BL10

181 750,00

207 195,00

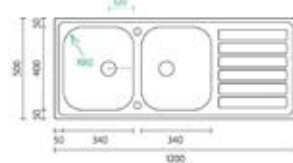

BALANCE 100-15

BK-BL20-1

ANTIGO

148 750,00

169 575,00

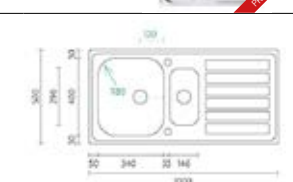

BK-BL20

185 750,00

211 755,00



PROMOÇÃO

BALANCE 100-50

BK-BL30

169 950,00

193 743,00

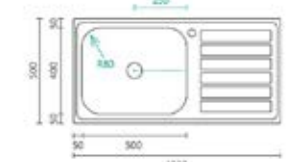

BALANCE 80-1



BK-BL40

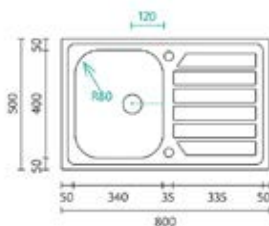

127 750,00

145 635,00



BALANCE 80-2



BK-BL50

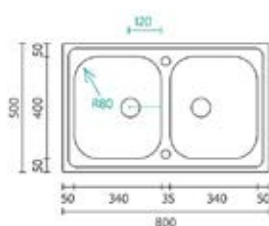

154 750,00

176 415,00



CIRCLE M6045



PROMOÇÃO

BK-CL10

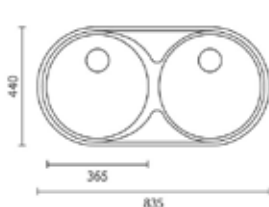

139 950,00

159 543,00



CIRCLE M7045



PROMOÇÃO

BK-CL20

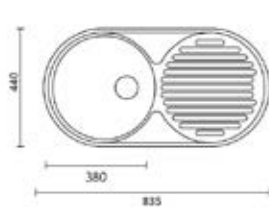

130 950,00

149 283,00



CIRCLE M5000



PROMOÇÃO

BK-CL30



108 750,00

123 975,00



CIRCLE M8160



BK-CL40

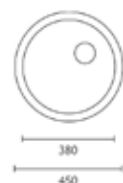

101 750,00

115 995,00



IBERICO 50



BK-IB10

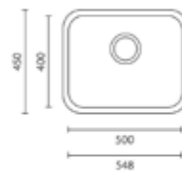

191 950,00

218 823,00



IBERICO 40



BK-IB20

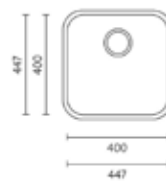

166 950,00

190 323,00



SQUARE M4050



BK-S010

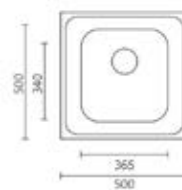

122 950,00

140 163,00



SAGAN M12000



BK-SG20

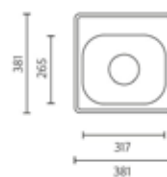

76 950,00

87 723,00



SIFÃO LAVA LOUÇAS



SE-550

VALVULA LAVA LOUÇAS DUPLA

43 750,00

49 875,00



SE-551

VALVULA LAVA LOUÇAS SIMPLE

22 750,00

25 935,00





d!anna

TEKA

ELECTRODOMÉSTICOS



PROMOÇÃO

FORNO TEKA MAESTRO HLF 940 BK SS REF: 4159223

TK-FN52	<ul style="list-style-type: none"> Multifunções SurroundTemp - 9 funções Sistema de limpeza Hydroclean PRO Touch Control com programação de início e fim de cozinhado Sistema de 2 guias Full Extension +Plus-Extension, 5 alturas Porta com 3 vidros Capacidade: 91 litros brutos / 90 cm de largura 	890x480	1 798 950,00	2 050 803,00
----------------	---	---------	--------------	---------------------



FORNO TEKA TOTAL HSF 900 SS REF: 41592220

TK-FN51	<ul style="list-style-type: none"> Multifunções - 7 funções Sistema de limpeza Hydroclean ECO Temporizador de fim de cozinhado Suportes laterais cromados, 5 alturas Porta com 2 vidros Capacidade: 91 litros brutos / 90 cm de largura 	890x480	1 316 250,00	1 500 525,00
----------------	---	---------	--------------	---------------------



PROMOÇÃO



FORNO TEKA TOTAL GAS HSF 924 G SS REF: 41596123

TK-FN54	<ul style="list-style-type: none"> Sistema de limpeza Teka Hydroclean® ECO Multifunções termostato ajustável relógio temporizador 88-64 litros 	898x595	1 648 950,00	1 879 803,00
----------------	--	---------	--------------	---------------------



FORNOS 60 CM



NOVIDADE



FORNO TEKA MAESTRO PIZZA HLB 85-G1 P BM REF: 111000056

TK-FN04	<ul style="list-style-type: none"> Multifunções SurroundTemp - 8 funções Dual Clean: Pirólise + Hydroclean Pro Touch Control com programação de início e fim de cozinhado Função automática MaestroPizza (340°C) para preparar uma autêntica pizza Sistema de 1 guia Plus-Extension, 5 alturas Porta com 4 vidros / Soft Close Bandeja rasa e profunda esmaltadas e grelha reforçada Accessórios incluídos: Pedra epá especial para pizza Capacidade: 71 litros brutos 	59,5x59,5	1 412 750,00	1 610 535,00
----------------	---	-----------	--------------	---------------------



NOVIDADE



FORNO TEKA STEAKMASTER BK SS REF: 111000037

TK-FN05	<ul style="list-style-type: none"> Multifunções SurroundTemp - 12 funções Dual Clean: Pirólise + Hydroclean PRO Display TFT 4" a cores 20 receitas pré-programadas Touch Control com comandos retroiluminados Função exclusiva SteakMaster com grill especial (700°C) e grelha em ferro fundido: grelha costeletas, entrecôt, torredós, hambúrgueres, salmão e atum em poucos minutos Funções SlowCook, ECO, fermentar massas Bloqueio de segurança para crianças Desligar de segurança com abertura da porta Sistema de 2 guias Plus-Extension, 5 alturas Porta com 4 vidros / Soft Close Bandeja profunda esmaltada e grelha reforçada Accessórios incluídos: faca de chef 21 cm + luva + guia de cozinhado 	59,5x59,5	2 098 750,00	2 392 575,00
----------------	--	-----------	--------------	---------------------



NOVIDADE



FORNO TEKA MAESTRO PIZZA HLB 8510 P BK REF:111000046

TK-FN06	<ul style="list-style-type: none"> Multifunções SurroundTemp- 8 funções Dual Clean: Pirólise +Hydroclean PRO Touch Control com programação de início e fim de cozinhado Função automática MaestroPizza (340°C) para preparar uma autêntica pizza napolitana Sistema de Iguia Plus-Extension, 5 alturas Porta com 4 vidros / Soft Close Acessórios incluídos: Pedra e pá especial pizza Capacidade: 71 Litros brutos 	59,5x59,5	1 168 750,00	1 332 375,00
----------------	---	-----------	--------------	---------------------



PROMOÇÃO

FORNO TEKA MAESTRO AIRFRY HLB 8416 BK REF: 111000045

TK-FN07	<ul style="list-style-type: none"> Multifunções SurroundTemp- 9 funções Sistema de limpeza Hydroclean PRO Touch Control com programação de início e fim de cozinhado Função AirFry com FryMaster Box para fritar sem gordura Sistema de Iguia Plus-Extension, 5 alturas Porta com 3 vidros /Soft Close Acessórios incluídos: Bandeja FryMaster Box Capacidade: 71 litros brutos 	59,5x59,5	997 500,00	1 137 150,00
----------------	---	-----------	------------	---------------------



FORNO TEKA MAESTRO HLB 840 BK SS REF: 41560077

TK-FN20	<ul style="list-style-type: none"> Multifunções SurroundTemp-9 funções Sistema de limpeza Hydroclean PRO Touch Control com programação de início e fim de cozinhado Sistema de Iguia Plus-Extension, 5 alturas Porta com 2 vidros Capacidade: 71 litros brutos 	59,5x59,5	729 250,00	831 345,00
----------------	--	-----------	------------	-------------------

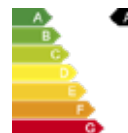

PROMOÇÃO

FORNO TEKA MAESTRO HLB 840 WH SS REF: 41560078

TK-FN30	<ul style="list-style-type: none"> Multifunções SurroundTemp-9 funções Sistema de limpeza Hydroclean PRO Touch Control com programação de início e fim de cozinhado Sistema de Iguia Plus-Extension, 5 alturas Porta com 2 vidros Capacidade: 71 litros brutos 	59,5x59,5	824 750,00	940 215,00
----------------	--	-----------	------------	-------------------



PROMOÇÃO

FORNO TEKA TOTAL HRB 6300 ANTRACITE REF: 111010010

TK-FN35	<ul style="list-style-type: none"> Multifunções SurroundTemp- 9 funções Sistema de limpeza Hydroclean PRO Relógio analógico com temporizador de fim de cozinhado Sistema de Iguia Plus-Extension, 5 alturas Porta com 2 vidros Capacidade: 71 litros brutos 	59,5x59,5	906 750,00	1 033 695,00
----------------	---	-----------	------------	---------------------





FORNO TEKA TOTAL HSB 635 SS REF: 41560144

TK-FN40	<ul style="list-style-type: none"> • Multifunções- 8 funções • Sistema de limpeza Hydroclean PRO • Touch Control com programação de início e fim de cozinhado • Sistema de Iguia Plus-Extension, 5alturas • Porta com 2 vidros • Capacidade: 71 litros brutos 	59,5x59,5	608 750,00	693 975,00
----------------	---	-----------	------------	-------------------



FORNO TEKA EASY HBB 605 SS REF: 41560053

TK-FN42	<ul style="list-style-type: none"> • Multifunções- 6funções • Sistema de limpeza Hydroclean ECO • Temporizador de fim de cozinhado • Suportes laterais cromados, 5alturas • Porta com 2 vidros • Capacidade: 71 litros brutos 	59,5x59,5	499 750,00	569 715,00
----------------	---	-----------	------------	-------------------

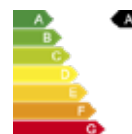

FORNO TEKA EASY HSB 610 BK REF: 41560114

TK-FN45-1	<ul style="list-style-type: none"> • Multifunções- 6funções • Sistema de limpeza Hydroclean ECO • Temporizador de fim de cozinhado • Sistema de Iguia Plus-Extension, 5 alturas • Porta com 2 vidros • Capacidade: 71 litros brutos 	59,5x59,5	628 750,00	716 775,00
------------------	---	-----------	------------	-------------------

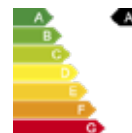

PROMOÇÃO



FORNO TEKA EASY HSB 610 WH REF: 41560115

TK-FN46-1	<ul style="list-style-type: none"> • Multifunções- 6funções • Sistema de limpeza Hydroclean ECO • Temporizador de fim de cozinhado • Sistema de Iguia Plus-Extension, 5 alturas • Porta com 2 vidros • Capacidade: 71 litros brutos 	59,5x59,5	628 750,00	716 775,00
------------------	---	-----------	------------	-------------------

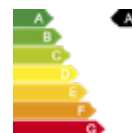

PROMOÇÃO



FORNO TEKA EASY HBB 435 SS REF: 41560011

TK-FN48	<ul style="list-style-type: none"> • Convencional - 3funções • Suportes laterais cromados, 5 alturas • Porta com 2 vidros • Capacidade: 75 litros brutos 	59,5x59,5	438 750,00	500 175,00
----------------	--	-----------	------------	-------------------

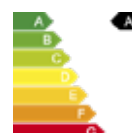

**PROMOÇÃO**
FORNO TEKA EASY GÁS HBB 724 G SS
REF: 111050000

TK-FN49	<ul style="list-style-type: none"> Forno estático a gás butano- 2funções Grill elétrico Temporizador de fim de cozinhado Porta com 2 vidros Capacidade: 77 litros brutos 	59,5x59,5	944 750,00	1 077 015,00
----------------	---	-----------	------------	---------------------

**GAVETAS AQUECIMENTO / MULTIUSOS****PROMOÇÃO**
GAVETA AQUECIMENTO MAESTRO CP 15 GS WH
REF: 40589921

TK-FN60	<ul style="list-style-type: none"> Gaveta de aquecimento com frontal Termostatoregulável 30-80°C Capacidade para 6 serviços Tapete anti derrapante Gaveta telescópica Sistema de abertura push-pull 	595x140	652 500,00	743 850,00
----------------	---	---------	------------	-------------------

**PROMOÇÃO**
GAVETA AQUECIMENTO MAESTRO CP 15 GS BK
REF: 40589920

TK-FN61	<ul style="list-style-type: none"> Gaveta de aquecimento com frontal Termostatoregulável 30-80°C Capacidade para 6 serviços Tapete anti derrapante Gaveta telescópica Sistema de abertura push-pull 	595x140	652 500,00	743 850,00
----------------	---	---------	------------	-------------------

**PROMOÇÃO**
GAVETA MULTIUSOS MAESTRO VS 152 GS BK
REF: 40589951

TK-FN62	<ul style="list-style-type: none"> Gaveta multiusos com frontal Embalamento a vácuo Balança de cozinha Suporte para rolo de alumínio e película aderente Espaço para guardar acessórios Gaveta telescópica Sistema de abertura push-pull 	595x140	877 500,00	1 000 350,00
----------------	---	---------	------------	---------------------

MÁQUINAS DE CAFÉ**PROMOÇÃO**
MÁQUINA CAFÉ MAESTRO CLC 855 GM BK SS
REF: 41598030

TK-MC11	<ul style="list-style-type: none"> Máquina de café automática 30 programas automáticos •Comandos eletrônicos Capacidade para regular intensidade, temperatura e quantidade de café Pressão 15 bar Moinho integrado edepósito para café pré- moído e em grão Depósito de água de 18, litros Capacidade: 2 chávenas em simultâneo 	595x455	2 924 950,00	3 334 443,00
----------------	--	---------	--------------	---------------------

MÁQUINA CAFÉ MAESTRO CLC 835 MC BK SS
REF: 40589513

TK-MC10	<ul style="list-style-type: none"> Máquina de café multi cápsulas e café moído Display TFT "4 a cores Touch Control com comandos retroiluminados Seleção tipo de café (curto, médio, longo, extra longo, infusões) Pressão 19 bar Depósito de residuo Depósito de água 1litro + 5 adaptadores de café incluídos 	595x455	1 412 750,00	1 610 535,00
----------------	--	---------	--------------	---------------------

NOVIDADE



MICRO-ONDAS MAESTRO ML 82-G1 BIS L BM DE1 REF: 112030009

TK-MC12	<ul style="list-style-type: none"> • Infinity G1 Design • Base cerâmica de aquecimento homogêneo • Grill rebatível 1200 W • 5 níveis de potência, 850 W saída micro-ondas - 3 funções • 9 menus de acesso direto / Início rápido 3 0 • Comando eletrônico com relógio digital • Prato tostador e grelha para grelhar e gratinar • Capacidade: 22 litros brutos 	595x390	968 750,00	1104 375,00
----------------	--	---------	------------	--------------------

NOVIDADE



MICRO-ONDAS MAESTRO ML 8220 BIS L BK REF: 112030001

TK-MC41	<ul style="list-style-type: none"> • Base cerâmica de aquecimento homogêneo • Grill rebatível, 1200 W • 5 níveis de potência, 850 W saída micro-ondas - 3 funções • 9 menus de acesso direto / Início rápido 30" • Comandos eletrônicos com relógio digital • Prato tostador e grelha para grelhar e gratinar • Capacidade: 22 litros brutos 	595x390	864 750,00	985 815,00
----------------	---	---------	------------	-------------------



MICRO-ONDAS MAESTRO ML 822 BIS L BK SS REF: 40584300

TK-MC40	<ul style="list-style-type: none"> • Base cerâmica de aquecimento homogêneo • Grill rebatível, 1200 W • 5 níveis de potência, 850 W saída micro-ondas - 3 funções • 9 menus de acesso direto / Início rápido 30" • Comandos eletrônicos com relógio digital • Prato tostador e grelha para grelhar e gratinar • Capacidade: 22 litros brutos 	595x390	864 750,00	985 815,00
----------------	---	---------	------------	-------------------



MICRO-ONDAS MAESTRO ML 8220 BIS L WH REF: 112030000

TK-MC30	<ul style="list-style-type: none"> • Base cerâmica de aquecimento homogêneo • Grill rebatível, 1200 W • 5 níveis de potência, 850 W saída micro-ondas - 3 funções • 9 menus de acesso direto / Início rápido 30" • Comandos eletrônicos com relógio digital • Prato tostador e grelha para grelhar e gratinar • Capacidade: 22 litros brutos 	595x390	958 950,00	1093 203,00
----------------	---	---------	------------	--------------------

PROMOCÃO



MICRO-ONDAS MAESTRO ML 820 BIS BK SS REF: 40584200

TK-MC22	<ul style="list-style-type: none"> • Micro-ondas + grill • Grill 1000 W • 5 níveis de potência, 750 W saída micro-ondas - 3 funções • 3 menus acesso direto / Início rápido 30" • Touch Control com temporizador e display TFT • Prato giratório de 0 24 cm • Capacidade: 20 litros brutos 	595x390	573 750,00	654 075,00
----------------	--	---------	------------	-------------------



MICRO-ONDAS MAESTRO ML 8200 BIS WH REF: 112060002

TK-MC21	<ul style="list-style-type: none"> • Micro-ondas + grill • Grill 1000W • 5 níveis de potência, 750 W saída micro-ondas - 3 funções • 3 menus acesso direto / Início rápido 30" • Touch Control com temporizador e display TFT • Prato giratório de 0 24 cm • Capacidade: 20 litros brutos 	595x390	636 750,00	725 895,00
----------------	---	---------	------------	-------------------

PROMOCÃO



MICRO-ONDAS TOTAL MS 620 BIH SS REF: 40584011

TK-MC18	<ul style="list-style-type: none"> • Micro-ondas • 5 níveis de potência, 750 W saída micro-ondas 1- função • 3 menus de acesso direto / Início rápido 30" • Comando eletrônico • Prato giratório 0 24 cm • Capacidade: 20 litros brutos 	595x390	452 750,00	516 135,00
----------------	---	---------	------------	-------------------

**PROMOÇÃO**
MICRO-ONDAS LIVRE EASY MWE 230 G SS
REF: 40590440

TK-MC15	<ul style="list-style-type: none"> • Micro-ondas +grill • Grill 1.000W • 5 níveis de potência, 800 W saída micro-ondas - 3funções • 8 menus de acesso direto / Início rápido 30" • Comando eletrônico • Prato giratório ø 27 cm • Capacidade: 23 litros brutos 	485x292	292 750,00	333 735,00
----------------	--	---------	------------	-------------------

**PROMOÇÃO**
MICRO-ONDAS LIVRE EASY MWE 230 G WH
REF: 40590441

TK-MC14	<ul style="list-style-type: none"> • Micro-ondas +grill • Grill 1.000W • 5 níveis de potência, 800 W saída micro-ondas - 3funções • 8 menus de acesso direto / Início rápido 30" • Comando eletrônico • Prato giratório ø 27 cm • Capacidade: 23 litros brutos 	485x292	277 750,00	316 635,00
----------------	--	---------	------------	-------------------

**PROMOÇÃO**
MICRO-ONDAS LIVRE EASY MGE 237 NXS BK
REF: 112240001

TK-MC13	<ul style="list-style-type: none"> • Micro-ondas +grill • Grill 1.000 W • 8 níveis de potência, 800 W saída micro-ondas 3- funções • 8 menus de acesso direto / Início rápido 30" • Control Easy Tronic • Prato giratório ø 27 cm • Temporizador de duração de cozinhado 0-95 minutos • Capacidade: 23 litros brutos 	485x293	285 750,00	325 755,00
----------------	---	---------	------------	-------------------

PLACAS INDUÇÃO**NOVIDADE**
PLACA INDUÇÃO MAESTRO MASTERSENSE AIR
AFF 87601 MST BK - REF: 112730000

TK-PC08	<ul style="list-style-type: none"> • Indução MasterSense Ari com exaustão incorporada • Vidro/biselado frontal. 80 cm largura • Touch Control MultiSlider com bloqueio de segurança/Programação do tempo de cozinhado • 5 combinações de cozinhado: 2(228-200)+2(235+189 mm)+2flex (235-385mm)- 7funções diretas de cozinhado/Função Power Plus/Stop &Go/Potência 7200 W • Exaustão com Função Fresh Air / Funcionamento temporizado / 9 velocidades +1 Intensiva • 2filtros metálicos de 21 camadas/Depósito de gorduras extrairável/Motor ECOPOWER • Extração- Int. 627 m³/h/Nível de potência sonora: min. 43 dBA- máx. 65 dBA 	800 x510	2 838 750,00	3 236 175,00
----------------	---	----------	--------------	---------------------

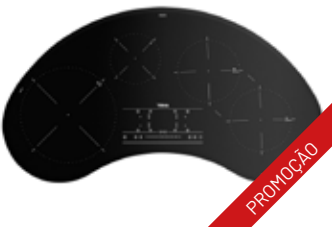
**PROMOÇÃO**
PLACA INDUÇÃO MAESTRO IRC 9430 KS
REF: 10210162

TK-PC10	<ul style="list-style-type: none"> • Placa de indução • Touch Control Slider com bloqueio de segurança Vidro biselado Schott Ceran® (4 m m altura) • Programador do tempo de cozinhado • 5 combinações de cozinhado: 1(ø 145 mm)+2 (ø 180 mm)+1(ø 280 mm)+ 1 Synchro nas zonas de ø 180 mm 	950x520	2 106 950,00	2 401 923,00
----------------	--	---------	--------------	---------------------

PLACA INDUÇÃO MAESTRO IZF 94300 BK MST
REF: 112510024

TK-PC21	<ul style="list-style-type: none"> • Vidro biselado frontal. 90 cm de largura • Flex • Touch Control MultiSlider c/ bloqueio • 5 combinações de cozinhado: 1(ø 185 mm) + 1(ø 280 mm) +2(235x189 mm) +1 flex (235x378 mm) • 3 funções de cozinhado • Função Power Plus • Stop &Go •Potência: 7200 W 	900x510	1 512 750,00	1 724 535,00
----------------	--	---------	--------------	---------------------



PROMOÇÃO

PLACA INDUÇÃO MAESTRO IZS 86630 BK MST REF: 112500030

TK-PC25	<ul style="list-style-type: none"> • MasterSense • Vidro biselado frontal 80 cm de largura • Flex com sistema Slide Cooking • Touch Control MultiSlider c/ bloqueio • 6 combinações de cozinhado: 1(Ø150 mm)+1(Ø 280 mm)+ 2 (228x200 mm) 1+flex (228x400 mm) 1+SlideFlex • 8 funções diretas de cozinhado • Função Power Plus / Stop &Go • Potência: 7200 W 	800 x510	1528 950,00	1743 003,00
----------------	---	----------	-------------	--------------------



PROMOÇÃO

PLACA INDUÇÃO MAESTRO IZC 63630 BK MST REF: 112500017

TK-PC32	<ul style="list-style-type: none"> • MasterSense • Vidro biselado frontal. 60 cm de largura • Touch Control MultiSlider c/ bloqueio • 3 zonas: 1(Ø 210 mm)+1(Ø 145 mm) + 1(Ø 320-180 mm) • 8 funções diretas de cozinhado • Função Power Plus • Stop &Go • Potência: 7200 W 	600 x510	1124 950,00	1282 443,00
----------------	--	----------	-------------	--------------------



PROMOÇÃO

PLACA INDUÇÃO MAESTRO IZC 64630 WH MST REF: 112500027

TK-PC31	<ul style="list-style-type: none"> • MasterSense • Vidro biselado frontal. 60 cm de largura • Touch Control MultiSlider c/ bloqueio • 3 zonas: 1(Ø 210 mm)+1(Ø 145 mm) + 1(Ø 320-180 mm) • 8 funções diretas de cozinhado • Função Power Plus • Stop &Go • Potência: 7200 W 	600 x510	1228 950,00	1401 003,00
----------------	--	----------	-------------	--------------------



PLACA INDUÇÃO EASY IZC 64010 BK MSS REF: 112520015

TK-PC35	<ul style="list-style-type: none"> • Vidro biselado frontal 60 cm de largura • Touch Control MultiSlider c/ bloqueio • 4 zonas: 2 (Ø 150 mm) + 2 (Ø 185 mm) • Função Power Plus • Stop & Go • Potência: 7.200 W 	600 x510	722 750,00	823 935,00
----------------	---	----------	------------	-------------------



PROMOÇÃO



PLACA INDUGÁS TOTAL JZC 64322 ABN BK REF: 112570113

TK-PC38	<ul style="list-style-type: none"> • Indução e gás natural (inclui adaptadores para butano) • Gas on Glass com biselado frontal • 9 níveis com controlo ExactFlame • Acendedor elétrico • Auto Lock • 4 zonas: 1(Ø 210 mm)+1(Ø145 mm)+1auxiliar(1.00 kW) + 1 rápido(2.80 kW) • Função Power Plus • Grelha de ferro fundido de ampla superfície 	600 x510	1138 950,00	1298 403,00
----------------	--	----------	-------------	--------------------



PLACA VITROCEÁMICA MAESTRO TR 951 REF: 10210002

TK-PC50	<ul style="list-style-type: none"> • Vidro total biselado. 90 cm largura • Touch Control com bloqueio • 5 zonas: 1 (ø 180 mm) + 1 (ø 160 mm) + 1 (ø 145 mm) + 1 (ø 120-180 mm) + 1 (ø 145-210/270 mm) • Função golpe de ebulição rápida • Função Power Plus • Potência: 8.900 W 	900 x510	931 750,00	1062 195,00
----------------	---	----------	------------	--------------------



PLACA VITROCERÁMICA EASY TZ PRO 6415 REF: 40239040

TK-PC40	<ul style="list-style-type: none"> • Vidro biselado frontal 60 cm largura • Touch Control com bloqueio • 4 zonas: 2 (ø 145 mm) + 1 (ø 180 mm) + 1 (ø 210 mm) • Função golpe de ebulição rápida • Função cronómetro com avisador acústico • Potência 6300 W 	600 x510	411 750,00	469 395,00
----------------	--	----------	------------	-------------------

PLACAS A GÁS



PLACA GÁS MAESTRO 5G GZC 95320 XBA BK REF: 112570187

TK-PC62	<ul style="list-style-type: none"> • Vidro biselado frontal. 90 cm largura • Gas on Glass de gás butano (injetores opcionais para gás natural) • 9 níveis com controlo ExactFlame • Acendedor elétrico • Auto Lock • 5 queimadores de gás: 1 duplo (5.00 kW) + 2 (1.75 kW) + 1 (2.80 kW) + 1 (1.00 kW) • Grelhas de ferro fundido de ampla superfície 	900 x510	975 750,00	1112 355,00
----------------	---	----------	------------	--------------------



PLACA GÁS MAESTRO 5G GZC 75330 XBA BK REF: 112570188

TK-PC61	<ul style="list-style-type: none"> • Vidro biselado frontal. 70 cm de largura • Gas on Glass de gás butano (injetores opcionais para gás natural) • 9 níveis com controlo ExactFlame • Acendedor elétrico • Auto Lock • 5 queimadores gás: 1duplo (4.00 kW) + 2 (1.75 kW) + 1 (2.80 kW) + 1 (1.00 kW) • Grelhas de ferro fundido de ampla superfície 	700 x510	958 950,00	1093 203,00
----------------	---	----------	------------	--------------------

PROMOÇÃO



PLACA GÁS MAESTRO 4G GZC 64320 XBA BK REF: 112570191

TK-PC60	<ul style="list-style-type: none"> • Vidro biselado frontal 60 cm de largura • Gas on Glass de gás butano (injetores opcionais para gás natural) • 9 níveis com controlo ExactFlame • Acendedor elétrico • Auto Lock • 4queimadores gás: 1duplo (4.00 kW) + 1 (1.75 kW) + 1 (2.80 kW) + 1 (1.00 kW) • Grelhas de ferro fundido de ampla superfície 	600 x510	614 750,00	700 815,00
----------------	---	----------	------------	-------------------



PROMOÇÃO



PLACA GÁS TOTAL EFX 60.1 2G 2H AI AL BTN REF: 112610036

TK-PC71	<ul style="list-style-type: none"> • 2 vitro + 2 queimadores de gás • Queimadores de alta eficiência • Acendedor elétrico • Grelhas de ferro fundido 	600 x510	628 950,00	717 003,00
----------------	--	----------	------------	-------------------



PROMOÇÃO



PLACA GÁS TOTAL EFX 70.1 5G AI AL DR CI BTN REF: 112610049

TK-PC73	<ul style="list-style-type: none"> • Comandos frontais incorporados com frente e m cor preto • 5 queimadores: 1 auxiliar (1,00 kW) • 2 semirrápidos (1,75 kW) 1 rápido (3,00 kW) • 1duplo anel (4,00 kW) 	750 x510	622 500,00	709 650,00
----------------	--	----------	------------	-------------------

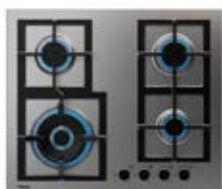

PLACA GÁS TOTAL EFX 60.1 4G AI AL DR CI BTN REF: 112610048

TK-PC70	<ul style="list-style-type: none"> • 60 cm largura • Gás butano (injetores opcionais para gás natural) • Acendedor elétrico • Auto Lock • 4 queimadores de gás: 1 duplo (4,00 kW) + 2 (1,75 kW) + 1 (1,00 kW) • Grelhas de ferro fundido de ampla superfície 	600 x510	506 750,00	577 695,00
----------------	--	----------	------------	-------------------

NOVIDADE



PLACA GÁS EASY HLX 640 KBCOE BK REF: 112620029

TK-PC74	<ul style="list-style-type: none"> • 58 cm largura • Gás butano (injetores opcionais para gás natural) • Acendedor elétrico • Auto Lock • 4 queimadores de gás: 1 (3,00 kW) + 2 (1,75 kW) + 1 (1,00kW) • Grelhas esmaltadas de ampla superfície 	580 x510	338 750,00	386 175,00
----------------	---	----------	------------	-------------------



PLACA GÁS EASY E 60.3 40 LLBOE BUT REF: 112620030

TK-PC75	<ul style="list-style-type: none"> • 60 cm largura • Gás butano • Auto Lock • 4 queimadores de gás: 2 (1,75 kW) + 1 (1,00 kW) + 1 (3,00 kW) • Grelhas esmaltadas 	600 x510	317 250,00	361 665,00
----------------	---	----------	------------	-------------------



PLACA GÁS EASY EFX 30.1 2G REF: 112610047

TK-PC69	<ul style="list-style-type: none"> • 30.5 cm de largura • Gás butano (injetores opcionais para gás natural) • Acendedor elétrico • Auto Lock • 2queimadores de gás: 1 (3,00 kW) + 1 (1,00 kW) • Grelha de ferro fundido de ampla superfície 	305 x510	249 750,00	284 715,00
----------------	---	----------	------------	-------------------



PROMOÇÃO

PLACA ELÉTRICA EASY EFX 30.1 2P

REF: 40214505

TK-PC79	<ul style="list-style-type: none"> • 30,5 cm de largura • 2 zonas: 1 (ø 145 mm) + 1 (ø 180 mm) • Limitador térmico em ambas as zonas • Potência 3.500 W 	305x510	255 250,00	290 985,00
---------	---	---------	------------	-------------------



GRELHADOR ELÉTRICO EASY EFX 30.1 SS

REF: 40214560

TK-PC80	<ul style="list-style-type: none"> • 30,5 cm de largura • Resistência elétrica • Termostato regulável • Cuba em inox • Grelha de ferro fundido • Desligar automático de segurança • Pedras vulcânicas incluídas 	300x510	432 750,00	493 335,00
---------	--	---------	------------	-------------------



PLACA VITROCERÂMICA TOTAL EFX 30.1 2H

REF: 40214405

TK-PC55	<ul style="list-style-type: none"> • Superfície em vidro com aro inox. 30,5 cm largura • Piloto indicativo de funcionamento • 2 zonas: 1 (ø 145 mm) + 1 (ø 180 mm) • Potência 3.000 W 	305x510	270 750,00	308 655,00
---------	---	---------	------------	-------------------



PROMOÇÃO



PLACA GÁS MAESTRO G1 GZC 31330 XBA BK

REF: 112570197

TK-PC67	<ul style="list-style-type: none"> • Vidro biselado frontal. 30 cm largura • Gas on Glass de gás butano (injetores opcionais para gás natural) • 9 níveis com controlo ExactFlame • Acendedor elétrico • Auto Lock • Iqueimador de gás de duplo, 4.00 Wk • Grelhas de ferro fundido de ampla superfície 	300x510	472 750,00	538 935,00
---------	---	---------	------------	-------------------

NOVIDADE



PLACA GÁS MAESTRO G2 GZC 32300 XBA BK

REF: 112570196

TK-PC68	<ul style="list-style-type: none"> • Vidro biselado frontal. 30 cm largura • Gas on Glass de gás butano (injetores opcionais para gás natural) • 9 níveis com controlo ExactFlame • Acendedor elétrico • Auto Lock • 2 queimadores de gás: 1 (1.00 kW) + 1 (2.80 kW) • Grelha de ferro fundido de ampla superfície 	300x510	344 750,00	393 015,00
---------	---	---------	------------	-------------------

NOVIDADE



PLACA VITROCERÂMICA EASY TZC 32320 TTC

REF: 112540002

TK-PC54	<ul style="list-style-type: none"> • Vidro biselado frontal. 30 cm largura • Touch Control MultiSlider c/ bloqueio • 2 zonas: 1 (ø 145 mm) + 1 (ø 120-180 mm) • Potência 2.900 W 	300x510	357 750,00	407 835,00
---------	--	---------	------------	-------------------

NOVIDADE



BARBECUE MAESTRO T-BBQ 4100 G SS REF: 111570003

TK-BB10

- Barbecue a gás butano
- Estrutura em inox
- Superfície de grill 65,5x44,5 cm
- 4 queimadores de gás, 32,2kW
- 1 queimador de gás auxiliar lateral, 3,51 kW
- Ignição ultra rápida
- Termômetro integrado na tampa
- 2 grelhas de ferro fundido com revestimento anti aderente
- Bandeja de recolha de gorduras
- Suporte lateral
- Rodas com bloqueio de segurança
- Potência máxima total: 16,41 kW

938 750,00

1070 175,00

NOVIDADE



BARBECUE MAESTRO T-BBQ 3100 G BK SS REF: 111570002

TK-BB20

- Barbecue a gás butano
- Estrutura e m inox com revestimento em cor preto
- Superfície de grill 58,3x40,8 cm
- 3 queimadores de gás, 3,22 kW
- 1 queimador de gás auxiliar lateral, 3,51 kW
- Ignição ultra rápida
- Termômetro integrado na tampa
- 2 grelhas de ferro fundido com revestimento anti aderente
- Bandeja de recolha de gorduras
- Suporte lateral
- Rodas com bloqueio de segurança
- Potência máxima total: 13,19 kW

587 750,00

670 035,00

CHAMINÉS DE TECTO



CHAMINÉ TETO MAESTRO DHT 1285 SS REF: 40484180

TK-EX05

- Decorativa de teto em aço inoxidável. 120 cm largura
- Sistema de aspiração perimetral
- Comando à distância. 6 velocidades +4 intensivas
- Funcionamento temporizado
- 4 lâmpadas LED
- Motor ECOPOWER
- Extração min.: 315 m³/h - int.: 807m³/h
- Nível de potência sonora: min. 47 dBA - máx. 60 dBA

120x600

2 548 950,00

2 905 803,00

PROMOÇÃO

NOVIDADE



CHAMINÉ TETO MAESTRO DHT 97670 TOS WH REF: 113100004

TK-EX06

- Decorativa de teto em vidro branco. 90 cm largura
- Sistema de aspiração perimetral
- Instalação Slimline 21 cm
- Comando à distância. 4 velocidades +2 intensivas
- Funcão FreshAir
- Funcionamento temporizado
- 3 lâmpadas LED
- Motor ECOPOWER
- Extração min.: 317 m³/h - int.: 808m³/h
- Nível de potência sonora: min. 50 dBA - máx. 67 dBA

900x600

2 025 750,00

2 309 355,00



CHAMINÉS DE ILHA

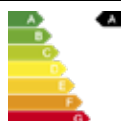

CHAMINÉ ILHA MAESTRO CC 485 SS ILHA REF: 40480330

TK-EX20

- Decorativa ilha. 40 cm largura
- Touch Control com display digital branco
- 3 velocidades +1 intensiva
- Funcionamento temporizado
- 2 lâmpadas LED
- Motor ECOPOWER
- Extração min.: 305 m³/h - int.: 71 m³/h
- Nível de potência sonora: min. 50 dBA - máx. 72 dBA

90/110x40

1 486 750,00

1 694 895,00



CHAMINÉ ILHA MAESTRO DPL 1185 T ILHA REF: 40483172

TK-EX22	<ul style="list-style-type: none"> Decorativa ilha. 10 cm largura Sistema de aspiração perimetral Touch Control com display digital branco 3 velocidades + intensiva Funcionamento temporizado 4 lâmpadas LED Motor ECOPOWER Extração min.: 331 m³/h- int.: 782 m³/h Nível de potência sonora: min. 54 dBA - máx. 66 dBA 	110x605	1552 750,00	1770 135,00
----------------	---	---------	-------------	--------------------



CHAMINÉ ILHA MAESTRO DH2 1285/985 ILHA REF: 120CM 40484670 / 90CM 40484640

TK-EX25	<ul style="list-style-type: none"> Decorativa ilha. 120 cm / 90 cm largura Comando eletrônico retroiluminado 3 velocidades + intensiva Funcionamento temporizado 4 Lâmpadas LED Motor ECOPOWER Extração min.: 31 m³/h- int.: 796 m³/h Nível de potência sonora: min. 52 dBA- máx. 66 dBA 	120x600	1777 500,00	2 026 350,00
TK-EX26	<ul style="list-style-type: none"> Decorativa ilha. 90 cm largura Comando eletrônico retroiluminado 3 velocidades + intensiva Funcionamento temporizado 4 lâmpadas LED Motor ECOPOWER Extração min.: 31 m³/h- int.: 796 m³/h Nível de potência sonora: min. 52 dBA- máx. 66 dBA 	90x60	1458 750,00	1 662 975,00

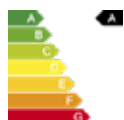

CHAMINÉ ILHA TOTAL DG3 985 ILHA REF: 40485150

TK-EX30	<ul style="list-style-type: none"> Decorativa ilha. 90 cm largura Comando eletrônico retroiluminado 3 velocidades + intensiva Funcionamento temporizado 4 lâmpadas LED Motor ECOPOWER Extração min.: 31 m³/h- int.: 796 m³/h Nível de potência sonora: min. 52 dBA - máx. 66 dBA 	90x60	1154 750,00	1 316 415,00
----------------	--	-------	-------------	---------------------

CHAMINÉS A PAREDE

NOVIDADE

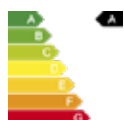

CHAMINÉ A PAREDE DVI 88-G1 EOS BM DE1 REF: 112930056

TK-EX08	<ul style="list-style-type: none"> Infinity G1 Design Decorativa vertical. 80 cm de largura Sistema de aspiração perimetral Comandos eletrônicos retroiluminados 3 velocidades + 1 intensiva Funcionamento temporizado 2 lâmpadas LED e Abertura pneumática Motor ECOPOWER Extração min. 232 m³/h- int.: 726 m³/h Função Fresh Air Aspiração Dual 	300x510	1062 750,00	1 211 535,00
----------------	---	---------	-------------	---------------------

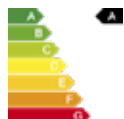

CHAMINÉ A PAREDE DVN TTC WH REF: 90CM 112950015/70CM 112950014/60CM 112950013

TK-EX14	<ul style="list-style-type: none"> Sistema de aspiração perimetral Touch Control com display digital branco 3 velocidades + intensiva Funcionamento temporizado 2 Lâmpadas LED / Motor de dupla turbina Extração min.: 260 m³/h- int.: 640 m³/h Nível de potência sonora: min. 54 dBA - máx. 64 dBA 	900x325	757 750,00	863 835,00
TK-EX15	<ul style="list-style-type: none"> Sistema de aspiração perimetral Touch Control com display digital branco 3 velocidades + intensiva Funcionamento temporizado 2 Lâmpadas LED / Motor de dupla turbina Extração min.: 260 m³/h- int.: 640 m³/h Nível de potência sonora: min. 54 dBA - máx. 64 dBA 	700x325	682 750,00	778 335,00
TK-EX16	<ul style="list-style-type: none"> Sistema de aspiração perimetral Touch Control com display digital branco 3 velocidades + intensiva Funcionamento temporizado 2 Lâmpadas LED / Motor de dupla turbina Extração min.: 260 m³/h- int.: 640 m³/h Nível de potência sonora: min. 54 dBA - máx. 64 dBA 	600x325	615 750,00	701 955,00

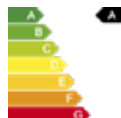

4

CHAMINÉ A PAREDE DVN TTC BK

REF: 90CM 112950012/70CM 112950011 /60CM 112950010

TK-EX17 <i>PROMOÇÃO</i>	<ul style="list-style-type: none"> Sistema de aspiração perimetral Touch Control com display digital branco 3 velocidades + 1intensiva 	900x325	727 750,00	829 635,00
TK-EX18	<ul style="list-style-type: none"> Funcionamento temporizado 2 Lâmpadas LED / Motor de dupla turbina Extração min.: 260 m³/h- int.: 640 m³/h 	700x325	602 750,00	687 135,00
TK-EX19 <i>PROMOÇÃO</i>	<ul style="list-style-type: none"> Nível de potência sonora: min. 54 dBA - máx. 64 dBA 	600x325	585 750,00	667 755,00

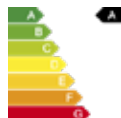

4

CHAMINÉ A PAREDE TOTAL DSH

REF: 90CM 40484202/70CM 40484201/60CM 40484200

TK-EX35	<ul style="list-style-type: none"> Comando eletrônico retroiluminado 3 velocidades + 1intensiva Funcionamento temporizado 	900x480	546 750,00	623 295,00
TK-EX36 <i>PROMOÇÃO</i>	<ul style="list-style-type: none"> Barra de iluminação LED Motor ECOPOWER Extração min.: 305 m³/h- int: 735 m³/h 	700x480	577 750,00	658 635,00
TK-EX37	<ul style="list-style-type: none"> Nível de potência sonora: min. 54 dBA - máx. 68 dBA 	600x480	508 750,00	579 975,00

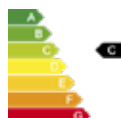

5

CHAMINÉ A PAREDE EASY DBP PRO

REF: 90CM 40460529/70CM 40460519/60CM 40460509

TK-EX10	<ul style="list-style-type: none"> Comando mecânico 4 velocidades 2 lâmpadas LED 	900x480	372 750,00	424 935,00
TK-EX11 <i>PROMOÇÃO</i>	<ul style="list-style-type: none"> Motor de dupla turbina Extração min.: 318 m³/h - máx. 613 m³/h 	700x480	375 750,00	428 355,00
TK-EX12	<ul style="list-style-type: none"> Nível de potência sonora: min. 55 dBA - máx. 68 dBA 	600x480	318 750,00	363 375,00

EXAUSTOR TELESCÓPICO P/ MOVÉL

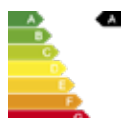

4

EXAUSTOR TELESCÓPICO CNL 6415

REF: SS 40436810/WH 40436811/BK 40436812

TK-EX48	<ul style="list-style-type: none"> Comando eletrônico 2 velocidades + 1intensiva Funcionamento temporizado 	600x300 BRANCO	272 750,00	310 935,00
TK-EX49	<ul style="list-style-type: none"> 2 lâmpadas LED Motor ECOPOWER Extração min.: 226 m³/h - int: 385 m³/h 	600x300 PRETO	272 750,00	310 935,00
TK-EX50	<ul style="list-style-type: none"> Nível de potência sonora: min. 57 dBA - máx. 64 dBA 	600x300 CROMADO	292 750,00	333 735,00

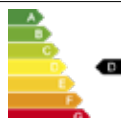

5

EXAUSTOR TELESCÓPICO TL

REF: 90CM 40474390/70CM 113080003/50CM 40474400

TK-EX51	<ul style="list-style-type: none"> Comando mecânico 2 velocidades 2 lâmpadas LED 	900x304	239 750,00	273 315,00
TK-EX60 <i>PROMOÇÃO</i>	<ul style="list-style-type: none"> Motor de dupla turbina Extração min: 160 m³/h - máx. 304 m³/h 	700x288	247 750,00	282 435,00
TK-EX61 <i>PROMOÇÃO</i>	<ul style="list-style-type: none"> Nível de potência sonora: min. 49 dBA - máx. 65 dBA 	500x304	172 750,00	196 935,00



COMBINADO LIVRE MAESTRO RFD 77820 SS REF: 113430005

TK-FG12

- Combinado de instalação livre
- 1898 mm de altura + 833 mm de largura + 685 mm de profund.
- Display digital com indicador e controlo da temperatura
- Motor inverter
- Tecnologia IonClean
- No Frost LongLife 3 circuitos independentes
- Gourmet Box com Soft Close e regulador de temperatura
- 2 VitaCare Box com regulação de humidade
- Função Férias
- Iluminação LED
- Capacidade total: 535 litros líquidos

1898x833

3 195 750,00

3 643 155,00

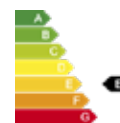

COMBINADO LIVRE MAESTRO RFD 77820 GBK REF: 113430004

TK-FG13

- Combinado de instalação livre
- 1898 mm de altura + 833 mm de largura + 685 mm de profund.
- Display digital com indicador e controlo da temperatura
- Motor inverter
- Tecnologia IonClean
- No Frost LongLife 3 circuitos independentes
- Gourmet Box com Soft Close e regulador de temperatura
- 2 VitaCare Box com regulação de humidade
- Função Férias
- Iluminação LED
- Capacidade total: 535 litros líquidos

1898x833

3 198 750,00

3 646 575,00

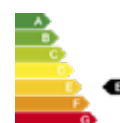

COMBINADO LIVRE MAESTRO RMF 77920 SS REF: 113430009

TK-FG14

- Combinado de instalação livre
- 1898 mm de altura + 833 mm de largura + 648 mm de profund.
- Display digital com indicador e controlo da temperatura
- Motor inverter
- Tecnologia IonClean
- No Frost LongLife 2 circuitos independentes
- Metal Cooling
- iFlex Zone (gaveta convertível Crisper to Chiller)
- 3 VitaCare Box
- Função Férias
- Iluminação LED
- Capacidade total: 511 litros líquidos

1898x833

3 378 750,00

3 851 775,00

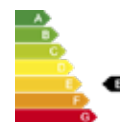

COMBINADO LIVRE MAESTRO RMF 77810 GBK REF: 113430042

TK-FG15

- Combinado de instalação livre
- 1898 mm de altura + 833 mm de largura + 648 mm de profund.
- Display digital com indicador e controlo da temperatura
- Motor inverter
- Tecnologia IonClean
- No Frost LongLife 2 circuitos independentes
- Metal Cooling
- iFlex Zone (gaveta convertível Crisper to Chiller)
- 3 VitaCare Box
- Função Férias
- Iluminação LED
- Capacidade total: 511 litros líquidos

1898x833

3 998 500,00

4 558 290,00



SIDE BY SIDE MAESTRO RLF 74925 SS REF: 113430010

TK-FG21

- Combinado americano de instalação livre
- 1788 mm de altura + 895 mm de largura 774 mm de profund.
- Display digital com indicador e controlo da temperatura
- Motor inverter
- Full No Frost
- Baron door
- 2 FreshBox
- IceMaker
- Função Férias • Iluminação LED
- Capacidade total: 516 litros líquidos

1788x895

3 112 750,00

3 548 535,00

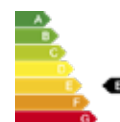



SIDE BY SIDE MAESTRO RLF 74920 SS REF: 113430011

TK-FG22

- Combinado americano de instalação livre
- 1788 mm de altura + 895 mm de largura 774 mm de profund.
- Display digital com indicador e controlo da temperatura
- Motor inverter
- Full No Frost
- 2 FreshBox
- IceMaker
- Função Férias
- Iluminação LED
- Capacidade total: 516 litros líquidos

1788x895

3 448 750,00

3 931 575,00



SIDE BY SIDE MAESTRO RLF 74930 SS REF: 113430059

TK-FG22-1

- Combinado de instalação livre
- 1769,4 mm altura + 911 mm largura + 666,2 mm profundidade
- Motor inverter
- No Frost LongLife • IceMaker
- Função Férias
- Iluminação LED
- Capacidade total: 529 litros líquidos

1769x911

1 756 750,00

2 002 695,00



SIDE BY SIDE MAESTRO RLF 74910 WH REF: 113430013

TK-FG23-1

- Combinado americano de instalação livre
- 1788 mm de altura + 895 mm de largura 774 mm de profund.
- Display digital com indicador e controlo da temperatura
- Motor inverter
- Full No Frost
- 2 FreshBox
- Twister IceMaker
- Função Férias
- Iluminação LED
- Capacidade total: 532 litros líquidos

1788x895

2 204 750,00

2 513 415,00



SIDE BY SIDE MAESTRO RLF 74910 GBK REF: 113430040

TK-FG23-2

- Combinado americano de instalação livre
- 1788 mm de altura + 895 mm de largura 774 mm de profund.
- Display digital com indicador e controlo da temperatura
- Motor inverter
- Full No Frost
- 2 FreshBox
- Twister IceMaker
- Função Férias
- Iluminação LED
- Capacidade total: 532 litros líquidos

1788x895

2 878 750,00

3 281 775,00



COMBINADO RETRO MAESTRO RBF 78615 GBK REF: 113400011

TK-FG36

- Combinado de instalação livre
- 1901 mm de altura + 605 mm de largura + 681 mm de profund.
- American Retro
- Motor inverter
- Tecnologia IonClean
- No Frost LongLife 2 circuitos independentes
- iZeroBox / iVitaCare Box
- Garrafeira cromada
- Prateleira FlexiRack • Iluminação LED
- Capacidade total: 330 litros líquidos

1901x605

1 874 750,00

2 137 215,00

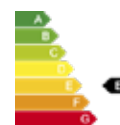



PROMOÇÃO

COMBINADO MAESTRO RBF 78720 GWH REF: 113400001

TK-FG31	<ul style="list-style-type: none"> • Combinado de instalação livre • 1920 mm de altura + 700 mm de largura + 721 mm de profund. • Display digital com indicador e controlo da temperatura • Motor inverter • No Frost LongLife 2circuitos independentes • Tecnologia IonClean • 1 ZeroBox / 1 VitaCare Box • Twister IceMaker/Prateleira FlexiRack • Função Férias • Iluminação LED • Capacidade: 481 litros líquidos 	1920x700	2 498 950,00	2 848 803,00
----------------	--	----------	--------------	---------------------

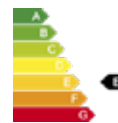

PROMOÇÃO

COMBINADO MAESTRO RBF 78720 GBK REF: 113400000

TK-FG32	<ul style="list-style-type: none"> • Combinado de instalação livre • 1920 mm de altura + 700 mm de largura + 721 mm de profund. • Display digital com indicador e controlo da temperatura • Motor inverter • No Frost LongLife 2circuitos independentes • Tecnologia IonClean • 1 ZeroBox / 1 VitaCare Box • Twister IceMaker/Prateleira FlexiRack • Função Férias • Iluminação LED • Capacidade: 481 litros líquidos 	1920x700	2 498 950,00	2 848 803,00
----------------	--	----------	--------------	---------------------

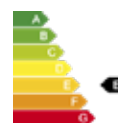

COMBINADO TOTAL NFL 345 C WH REF: 40672050

TK-FG33	<ul style="list-style-type: none"> • Combinado de instalação livre • 1880 mm de altura +595 mm de largura 635 mm de profund. • Display digital com indicador e controlo da temperatura • Sistema anti bactérias • Full No Frost • 2 FreshBox • Iluminação LED • Capacidade: 310 litros líquidos 	1880x595	1 082 750,00	1 234 335,00
----------------	---	----------	--------------	---------------------

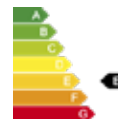

COMBINADO TOTAL NFL 345 C SS REF: 40672051

TK-FG34	<ul style="list-style-type: none"> • Combinado de instalação livre • 1880 mm de altura +595 mm de largura 635 mm de profund. • Display digital com indicador e controlo da temperatura • Sistema anti bactérias • Full No Frost • 2 FreshBox • Iluminação LED • Capacidade: 310 litros líquidos 	1880x595	1 122 750,00	1 279 935,00
----------------	---	----------	--------------	---------------------

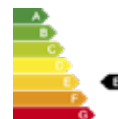

PROMOÇÃO

FRIGORIFICO MAESTRO RSL 73640 SS REF: 113300005

TK-FG25	<ul style="list-style-type: none"> • Frigorífico de instalação livre • 1850 mm de altura +595 mm de largura + 657 mm de profund. • Display digital com indicador e controlo da temperatura • Motor inverter • Full No Frost • 2 FreshBox • Iluminação LED • Capacidade: 362 litros líquidos 	1855x595	1 498 750,00	1 708 575,00
----------------	---	----------	--------------	---------------------

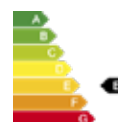



ARCA MAESTRO RSF 75640 SS REF: 113330002

TK-FG44

- Arca de instalação livre
- 1850 mm de altura +595 mm de largura 657 mm de profund.
- Arca 1 porta convertível em frigorífico
- Display digital com indicador e controlo da temperatura
- Motor inverter
- No Frost
- Arrefecimento e congelação rápida
- 5 gavetas transparentes
- Capacidade: 273 litros líquidos

1855x595

1 724 750,00

1 966 215,00

PROMOÇÃO



FRIGORIFICOS / COMBINADOS / ARCAS DE ENCASTRE



COMBINADO ENCASTRE MAESTRO RBF FI EU REF: 113560014

TK-FG39

- Combinado de integração
- 1770 mm de altura +540 mm de largura + 545 mm de profund.
- Controlo mecânico
- Motor inverter
- No Frost no congelador
- 1VitaCare Box
- Prateleira FlexiRack • Garrafeira cromada
- Sistema de integração com porta deslizante
- Capacidade: 242 litros líquidos

1775x540

1 194 750,00

1 362 015,00



NOVIDADE



COMBINADO ENCASTRE MAESTRO RBF 77360 FI EU REF: 113560017

TK-FG37

- Combinado de integração
- 1935 m de altura +540 m de largura + 545 mm de profundidade
- Controlo eletrónico com display
- Motor inverter
- No Frost LongLife 2circuitos independentes
- 1FreshBox / 1ZeroBox
- Garrafeira cromada
- Sistema de integração com porta deslizante
- Capacidade bruta: 284 litros líquidos

1935x540

1 795 750,00

2 047 155,00



FRIGORIFICO ENCASTRE TOTAL RSL 73350 FI EU REF: 113460007

TK-FG41

- Frigorífico de integração
- 1775 mm de altura +540 mm de largura 545 mm de profund.
- Controlo eletrónico com display
- Motor inverter
- Descongelação automática no frigorífico • 2 FreshBox
- Garrafeira cromada
- Sistema de integração door on door
- Capacidade: 309 litros líquidos

1775x540

1 390 500,00

1 585 170,00



ARCA ENCASTRE TOTAL RSF 73350 FI EU REF: 113500009

TK-FG42

- Arca de integração
- 1775 mm de altura +540 mm de largura 545 mm de profund.
- Controlo eletrónico com display
- Motor inverter
- No Frost
- Congelação rápida
- 8 compartimentos independentes
- Sistema de integração door on door
- Capacidade: 220 litros líquidos

1775x540

1 525 750,00

1 739 355,00





FRIGORIFICO ENCASTRE TOTAL RSL 41150 BU EU REF: 113470015

TK-FG29

- Frigorífico de integração baixo bancada
- 820 mm de altura +598 mm de largura 545 mm de profund.
- Termostato regulável
- 3 prateleiras de vidro
- Iluminação LED
- Sistema de integração door on door
- Capacidade: 130 litros líquidos

820x598

837 250,00

954 465,00



ARCA ENCASTRE TOTAL RSF 41150 BU EU REF: 113510000

TK-FG46

- Arca de integração baixo bancada
- 820 mm de altura +598 mm de largura 545 mm de profundidade
- Controle mecânico
- Motor inverter
- Termostato regulável • Congelamento rápida
- 3 gavetas transparentes
- Sistema de integração door on door
- Capacidade: 94 litros líquidos

820x598

850 500,00

969 570,00



FRIGORIFICO BAIXO BANCADA LIVRE



PROMOÇÃO

FRIGORIFICO LIVRE TOTAL TS1 138 WH REF: 40607710

TK-FG28

- Frigorífico de instalação livre baixo bancada
- 845 mm de altura +501 mm de largura + 540 mm de profundidade
- Motor inverter
- Termostato regulável
- 2 prateleiras de vidro
- Congelador integrado
- 1 FreshBox
- Iluminação interior
- Capacidade: 98 litros líquidos

845x501

516 750,00

589 095,00



GARRAFEIRAS



GARRAFEIRA LIVRE MAESTRO RVF 10051 REF: 113610002

TK-FG91

- 1256,3 mm de altura +475 mm de largura +476,5 mm de profund.
- Garrafeira de instalação livre / 51 garrafas
- Display eletrônico com controle de temperatura
- Temperatura ajustável (5-189C)
- 8 +3 prateleiras de madeira
- Sistema de refrigeração SurroundAir
- Sistema Smart Control
- Sistema anti vibração
- Capacidade: 159 litros líquidos

1256x475

1 228 750,00

1 400 775,00



GARRAFEIRA LIVRE MAESTRO RVF 10032 REF: 113610001

TK-FG92

- 785 mm de altura +380 mm de largura +576,5 mm de profund.
- Garrafeira de instalação livre / 32 garrafas
- Display eletrônico com controle de temperatura
- Temperatura ajustável (5-189C)
- 5 +1 prateleiras de madeira
- Sistema de refrigeração SurroundAir
- Sistema Smart Control • Sistema anti vibração
- Capacidade: 83 litros líquidos

785x380

946 750,00

1 079 295,00



NOVIDADE



GARRAFEIRA ENCASTRE MAESTRO RVU 20046 REF: 113600008

TK-FG90

- 820 mm de altura +595 mm de largura +619 mm de profund.
- Garrafeira de integração ou de instalação livre / 46 garrafas
- Display eletrônico com controle de temperatura
- 2 zonas de temperatura ajustáveis (5-10°C e 10-189C)
- 6 prateleiras de madeira
- Sistema de refrigeração SurroundAir
- Sistema Smart Control • Sistema anti vibração
- Capacidade: 134 litros líquidos

820x595

1 822 500,00

2 077 650,00



NOVIDADE



MÁQUINA LAVAR LOUÇA ENCASTRE MAESTRO DFI 76950 REF: 114260004

TK-ML20	<ul style="list-style-type: none"> • Sliding door • Capacidade: 15 serviços • Terceiro cesto superior Multiflex-3 • Motor inverter • Tecnologia IonClean • Display digital LED • 9 programas- 6 temperaturas • Programa DualCare / ECO / Auto / Rápido 30° • Tecnologia Eco3 Plus • Sinal luminoso BeamOnFloor • Abertura automática da porta PremiumDry • AquaStop • SmartSensor • Ruído máximo 42 dbA 	818x598	1 082 750,00	1 234 335,00
----------------	--	---------	--------------	---------------------



MÁQUINA LAVAR LOUÇA ENCASTRE TOTAL DFI 46900 - 46700 REF: 114270009

TK-ML22	<ul style="list-style-type: none"> • Capacidade: 14 serviços • Motor inverter • Display digital LED • 9 programas- 6 temperaturas • Programa DualCare / ECO / Auto / Rápido 30° • Tecnologia Eco3 Plus • AquaStop / SmartSensor • Ruído máximo 46 dbA 	818x598	812 750,00	926 535,00
----------------	---	---------	------------	-------------------



MÁQUINA LAVAR LOUÇA ENCASTRE PARCIAL TOTAL DSI 46750 SS REF: 114270011

TK-ML25	<ul style="list-style-type: none"> • Capacidade: 13 serviços • Display digital LED • 7 programas- 5 temperaturas • Programa Whisper / ECO / Auto • Tecnologia Eco3 Plus • AquaStop / SmartSensor • Ruído máximo 47 dbA 	815x598	914 750,00	1 042 815,00
----------------	---	---------	------------	---------------------



MÁQUINAS LAVAR LOUÇA LIVRES



MÁQUINA LAVAR LOUÇA LIVRE TOTAL DFS 46710 WH REF: 114270015

TK-ML28	<ul style="list-style-type: none"> • Capacidade: 14 serviços • Display digital LED • 7 programas- 5 temperaturas • Programa Whisper / 1 hora / ECO / AUTO • Tecnologia Eco3 Plus • SmartSensor • Ruído máximo 47 dbA 	845x598	769 750,00	877 515,00
----------------	---	---------	------------	-------------------

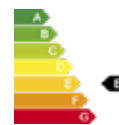

MÁQUINA LAVAR LOUÇA LIVRE TOTAL DFS 46710 SS REF: 114270016

TK-ML29	<ul style="list-style-type: none"> • Capacidade: 14 serviços • Display digital LED • 7 programas- 5 temperaturas • Programa Whisper / 1 hora / ECO / AUTO • Tecnologia Eco3 Plus • SmartSensor • Ruído máximo 47 dbA 	845x598	878 750,00	1 001 775,00
----------------	---	---------	------------	---------------------

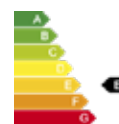



MÁQUINA LAVAR ROUPA LIVRE MAESTRO WMT 40720 WH REF: 113910001

TK-ML11

- Capacidade: 7Kg
- Seletor de centrifugação: 1.200 - 400 r.p.m.
- Painel de comandos eletrónico com display digital LED
- 15 programas (super-rápido 15, antialérgico)
- Sistema SmartWash e Tecnologia Eco3 Plus

845x596

742 750,00

846 735,00

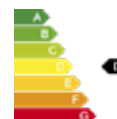

MÁQUINA LAVAR ROUPA LIVRE MAESTRO WMT 40720 SS REF: 113910002

TK-ML12

- Capacidade: 7Kg
- Seletor de centrifugação: 1.200 - 400 r.p.m.
- Painel de comandos eletrónico com display digital LED
- 15 programas (super-rápido 15, antialérgico)
- Sistema SmartWash e Tecnologia Eco3 Plus

845x596

852 750,00

972 135,00



MÁQUINAS LAVAR ROUPA ENCASTRE



MÁQUINA LAVAR ROUPA ENCASTRE TOTAL LI5 1080 EUI REF: 114000005

TK-ML15

- Frigorífico de integração baixo bancada
- 820 mm de altura +598 mm de largura 545 mm de profund.
- Termostato regulável
- 3 prateleiras de vidro
- Iluminação LED
- Sistema de integração door on door
- Capacidade: 130 litros líquidos

820x596

1 108 750,00

1 263 975,00

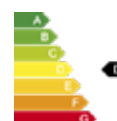

MÁQUINAS LAVAR E SECAR ROUPA



MÁQUINA LAVAR E SECAR ROUPA LIVRE MAESTRO WDT 71040 WH REF: 113960004

TK-ML18

- Capacidade lavagem: 10 Kg
- Capacidade secagem: 6 Kg
- Seletor de centrifugação: 1.400- 600 r.p.m.
- Painel de comandos eletrónico com display digital LED
- Secagem por condensação e com sensor de humidade
- 15 programas (super-rápido 12, ECO, lã e roupa delicada)
- Sistema SprayWash e Tecnologia Eco3 Plus
- Regulação automática do consumo de água
- Óculo de vidro de 0 33 cm
- Tambor SoftCare • Motor T-inverter

845x596

1 552 750,00

1 770 135,00



MÁQUINAS SECAR ROUPA



MÁQUINA SECAR ROUPA LIVRE MAESTRO SCT 70810 WH REF: 114060002

TK-ML19

- Secagem por condensação
- Capacidade: 8Kg
- Painel de comandos eletrónico com display digital LED
- 15 programas (Express 29', rápido 12)
- Função antirrugas
- Sensor de temperatura ExcelentDry (secagem uniforme)
- Filtro 4D
- Condensador Easyclean

845x596

824 750,00

940 215,00





TERMOACUMULADOR TOTAL SMART EWH 100 VE-D REF: 42080340

TK-TM10	<ul style="list-style-type: none"> • Instalação vertical • SMART CONTROL eletrônico • Capacidade: 100 litros • Cuba esmaltada em safira • Indicador de temperatura LED • Temperatura regulável: 30^o-75^oC • Válvula de pressão >7,5 bar • Pressão máxima: 0,75 Mpa • Válvula de segurança,proteção contra sobreaquecimento e aquecimento a seco • Potência 1.500 W • Espessura do isolamento: 20 mm • Ânodo de magnésio • N.º médio de usuários: 3-5 pessoas 	956x450	472 750,00	538 935,00
----------------	---	---------	------------	-------------------



TERMOACUMULADOR TOTAL SMART EWH 80 VE-D REF: 42080330

TK-TM11	<ul style="list-style-type: none"> • Instalação vertical • SMART CONTROL eletrônico • Capacidade: 80 litros • Cuba esmaltada em safira • Indicador de temperatura LED • Temperatura regulável: 30^o-75^oC • Válvula de pressão >7,5 bar • Pressão máxima: 0,75 Mpa • Válvula de segurança,proteção contra sobreaquecimento e aquecimento a seco • Potência 1.500 W • Espessura do isolamento: 20 mm • Ânodo de magnésio • N.º médio de usuários: 2-4 pessoas 	791x450	418 750,00	477 375,00
----------------	--	---------	------------	-------------------



TERMOACUMULADOR TOTAL SMART EWH 50 VE-D REF: 42080320

TK-TM12	<ul style="list-style-type: none"> • Instalação vertical • SMART CONTROL eletrônico • Capacidade: 50 litros • Cuba esmaltada em safira • Indicador de temperatura LED • Temperatura regulável: 30^o-75^oC • Válvula de pressão >7,5 bar • Pressão máxima: 0,75 Mpa • Válvula de segurança,proteção contra sobreaquecimento e aquecimento a seco • Potência 1.500 W • Espessura do isolamento: 20 mm • Ânodo de magnésio • N.º médio de usuários: 2-3 pessoas 	759x385	330 750,00	377 055,00
----------------	--	---------	------------	-------------------



TERMOACUMULADOR TOTAL SMART EWH 30 VE-D REF: 42080310

TK-TM13	<ul style="list-style-type: none"> • Instalação vertical • SMART CONTROL eletrônico • Capacidade: 30 litros • Cuba esmaltada em safira • Indicador de temperatura LED • Temperatura regulável: 30^o-75^oC • Válvula de pressão >7,5 bar • Pressão máxima: 0,75 Mpa • Válvula de segurança,proteção contra sobreaquecimento e aquecimento a seco • Potência 1.500 W • Espessura do isolamento: 20 mm • Ânodo de magnésio • N.º médio de usuários: 1-2 pessoas 	606x340	290 250,00	330 885,00
----------------	--	---------	------------	-------------------



TERMOACUMULADOR TOTAL SMART EWH 15 VE-D REF: 42080300

TK-TM14	<ul style="list-style-type: none"> • Instalação vertical • SMART CONTROL eletrônico • Capacidade: 15 litros • Cuba esmaltada em safira • Indicador de temperatura LED • Temperatura regulável: 30^o-75^oC • Válvula de pressão >7,5 bar • Pressão máxima: 0,75 Mpa • Válvula de segurança,proteção contra sobreaquecimento e aquecimento a seco • Potência 1.500 W • Espessura do isolamento: 20 mm • Ânodo de magnésio • N.º médio de usuários: 1-2 pessoas 	384x340	249 750,00	284 715,00
----------------	--	---------	------------	-------------------





ENTREGAS

Entregamos as suas compras ou encomendas diretamente ao seu domicílio ou na sua obra.



MONTAGEM

Dispomos de equipas de montagem especializadas para proceder à montagem dos móveis, cozinhas, casas de banho e outros elementos vendidos por nós.



ORÇAMENTAÇÃO

Fazemos, optimizamos e disponibilizamos orçamentos completos para clientes particulares, profissionais e empresas.

NOTAS



MATERIAIS DE CONSTRUÇÃO • CASAS DE BANHO • ELECTRODOMÉSTICOS • DECORAÇÃO

LOJA E SHOWROOM

Rua do Imetro S/Nº
Morro Bento - Samba - Luanda
T. +244 940 617 270
E. loja@dama.ao

ARMAZÉM

Rua Direita da Toyota S/Nº
Morro Bento - Samba - Luanda
T. +244 926 646 036
E. geral@dama.ao

COMERCIAL

T. +244 949 546 578
E. comercial@dama.ao



Loja online: dama.ao

TEKA

ASSISTÊNCIA TÉCNICA

DOMEP

T. +244 933 907 902
E. geral@domep.io