

A close-up, profile view of a woman's face, looking upwards. Her skin is a rich, warm brown. She has dramatic, dark eye makeup and long, dark eyelashes. Her lips are coated in a glossy, dark brown lipstick. The right side of her face is adorned with intricate, shimmering gold makeup, including large, teardrop-shaped accents and smaller dots. The background is a soft, golden-yellow gradient, and the foreground is filled with numerous small, bright gold particles and larger, shimmering gold droplets, creating a sense of luxury and elegance.

dama

SANITÁRIOS

AGOSTO 2024



BOHEMIC PRETO MATE

RB-BH01-P BOHEMIC PACK SANITA / SANITA + TANQUE + TAMPO SOFT CLOSE CLIP OFF 732 250,00 **834 765,00**

RB-BH07-P BOHEMIC BIDÉ COMPACTO 456 250,00 **520 125,00**

RB-L022/P BOHEMIC LAVATÓRIO POU SAR 455x325mm 227 500,00 **259 350,00**

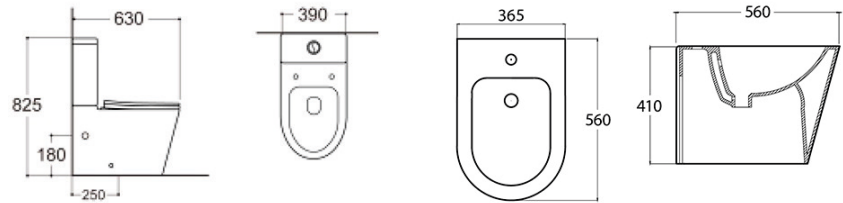

ELEGANT PRETO MATE

RB-EL02-1 ELEGANT SANITA SUSPensa + TAMPO SOFT CLOSE CLIP OFF 488 750,00 **557 175,00**

RB-EL08-1 ELEGANT BIDÉ SUSPENSO 424 750,00 **484 215,00**

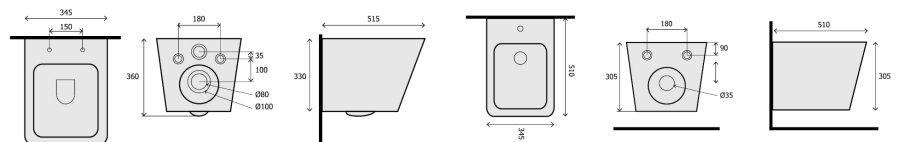



FLY CAPPUCINO MATE

RB-FY01-C	FLY PACK SANITA / SANITA + TANQUE + TAMPO SOFT CLOSE CLIP OFF	732 250,00	834 765,00
RB-FY07-C	FLY BIDÉ COMPACTO	456 250,00	520 125,00
RB-L022/CP	BOHEMIC LAVATÓRIO POUSAR 455x325mm	243 750,00	277 875,00

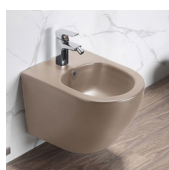
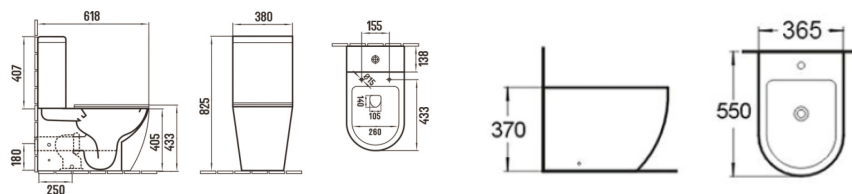

FLY SUSPENSO CAPPUCINO MATE

RB-FY02-C	FLY SANITA SUSPENSA + TAMPO SOFT CLOSE CLIP OFF	488 750,00	557 175,00
RB-FY08-C	FLY BIDÉ SUSPENSO	424 750,00	484 215,00

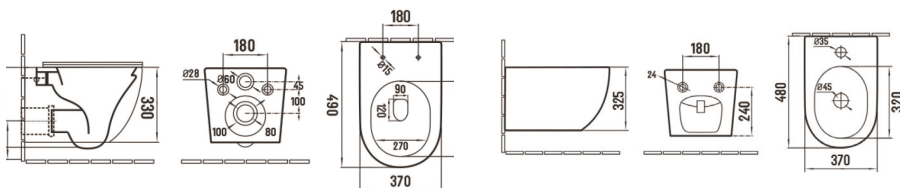



GLAMIC CINZA MATE

RB-GL01-C	GLAMIC PACK SANITA / SANITA + TANQUE + TAMPO SOFT CLOSE CLIP OFF	732 250,00	834 765,00
RB-GL07-C	GLAMIC BIDÉ COMPACTO	456 250,00	520 125,00
RB-L022/C	BOHEMIC LAVATÓRIO POUSAR 455x325mm	196 250,00	223 725,00

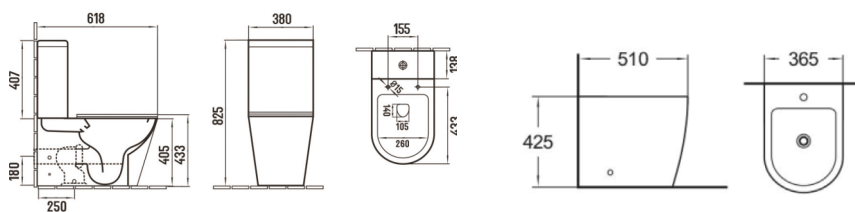

GLAMIC SUSPENSO CINZA

RB-GL02-C	GLAMIC SANITA SUSPENSA + TAMPO SOFT CLOSE CLIP OFF	488 750,00	557 175,00
RB-GL08-C	GLAMIC BIDÉ SUSPENSO	424 750,00	484 215,00

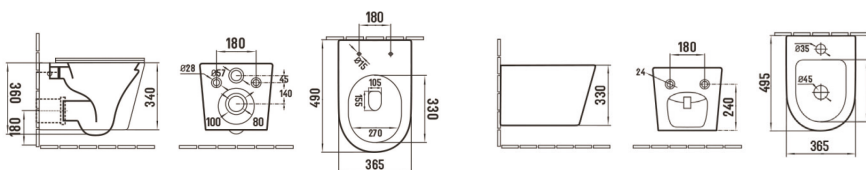



ELEGANT CINZA ESCURO MATE

RB-EL01-C ELEGANT PACK SANITA / SANITA + TANQUE + TAMPO SOFT CLOSE CLIP OFF 732 250,00 **834 765,00**

RB-EL07-C ELEGANT BIDÉ COMPACTO 456 250,00 **520 125,00**

RB-L022/CE BOHEMIC LAVATÓRIO POUSAR 455x325mm 196 250,00 **223 725,00**

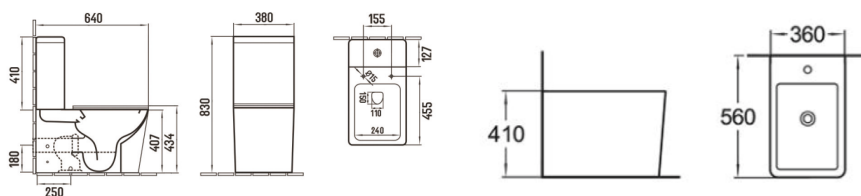

BOHEMIC BRANCO MATE

RB-BH01-B BOHEMIC PACK SANITA / SANITA + TANQUE + TAMPO SOFT CLOSE CLIP OFF 658 750,00 **750 975,00**

RB-BH07-M BOHEMIC BIDÉ COMPACTO 412 750,00 **470 535,00**

RB-L022/B BOHEMIC LAVATÓRIO POUSAR 455x325mm 196 250,00 **223 725,00**

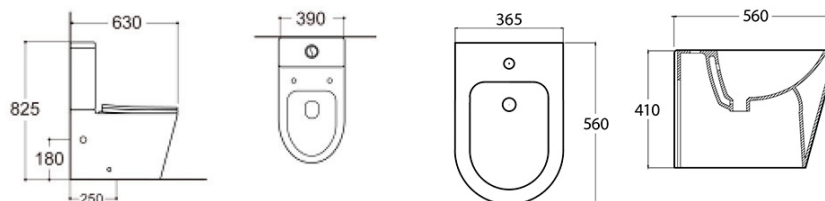



R2 BRANCO

CF-R201 R2 PACK SANITA / SANITA + TANQUE + TAMPO SOFT CLOSE CLIP OFF 412 750,00 **470 535,00**

CF-R207 R2 BIDÉ COMPACTO 248 750,00 **283 575,00**

CF-L016 A2S LAVATÓRIO POU SAR 455x395mm 104 750,00 **119 415,00**

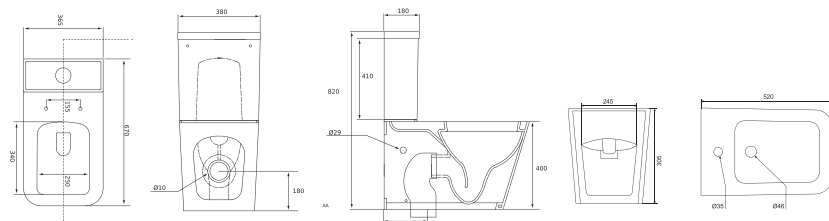

R2 SUSPENSO BRANCO

CF-R202 R2 SANITA SUSPENSA + TAMPO SOFT CLOSE CLOSE CLIP OFF 322 750,00 **367 935,00**

CF-R208 R2 BIDÉ SUSPENSO 278 750,00 **317 775,00**

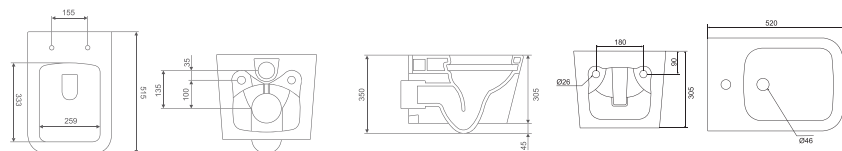



A2 BRANCO

CF-A201 A2 PACK SANITA / SANITA + TANQUE + TAMPO SOFT CLOSE CLIP OFF 358 750,00 **408 975,00**

CF-A207 A2 BIDÉ COMPACTO 218 750,00 **249 375,00**

CF-L017 A2R LAVATÓRIO POU SAR 415mm 84 750,00 **96 615,00**

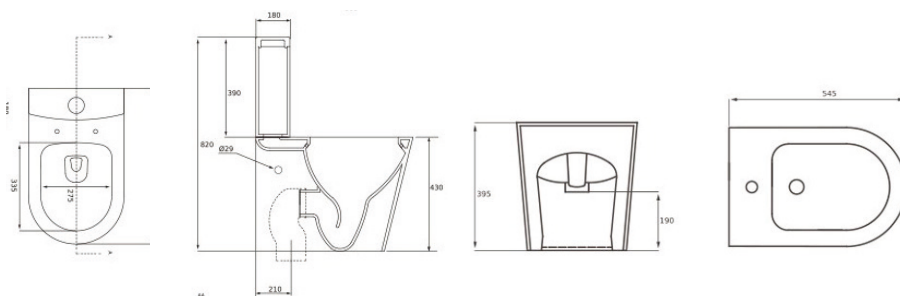

A2 SUSPENSO BRANCO

CF-A202 A2 SANITA SUSPENSA + TAMPO SOFT CLOSE CLIP OFF 262 750,00 **299 535,00**

CF-A208 A2 BIDÉ SUSPENSO 228 750,00 **260 775,00**

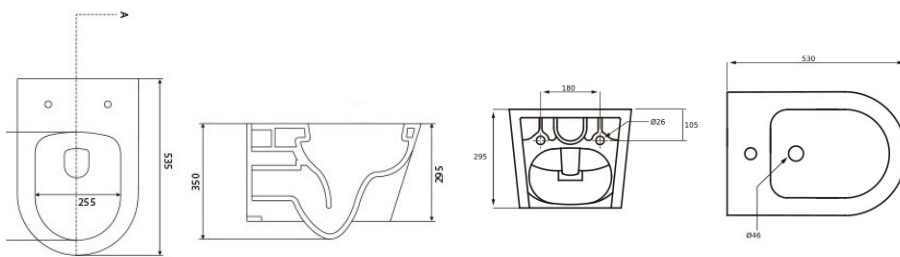



STYLE S BRANCO

CF-SS01 STYLE S PACK SANITA / SANITA + TANQUE + TAMPO SOFT CLOSE CLIP OFF 298 750,00 **340 575,00**

CF-SS08 STYLE S BIDÊ COMPACTO 148 750,00 **169 575,00**

CF-L015 A2 LAVATÓRIO POU SAR 450x330mm 86 750,00 **98 895,00**

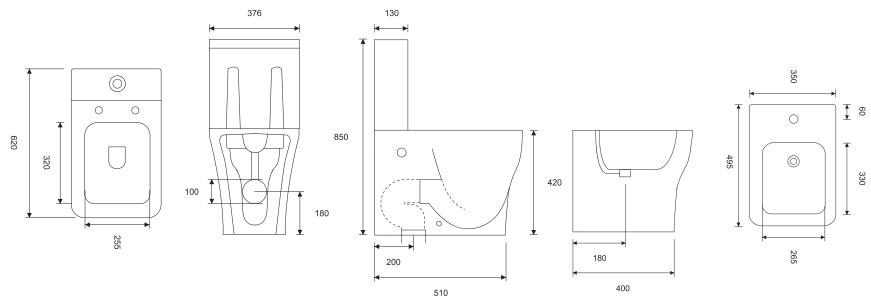

STYLE S SUSPENSO BRANCO

CF-SS02 STYLE S SUSPENSO / SANITA SUSPENSA + TAMPO SOFT CLOSE CLIP OFF 198 750,00 **226 575,00**

CF-SS07 STYLE S SUSPENSO / BIDÊ SUSPENSO 192 750,00 **219 735,00**

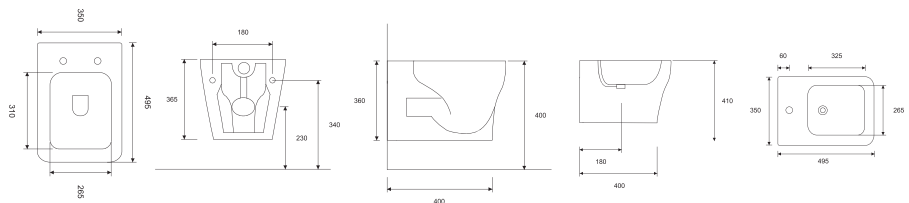



STYLE R BRANCO

CF-SR01	STYLE R PACK SANITA / SANITA + TANQUE + TAMPO SOFT CLOSE CLIP OFF	298 750,00	340 575,00
CF-SR08	STYLE R BIDÊ COMPACTO	156 750,00	178 695,00
CF-L017	A2R LAVATÓRIO POUVAR 415mm	84 750,00	96 615,00

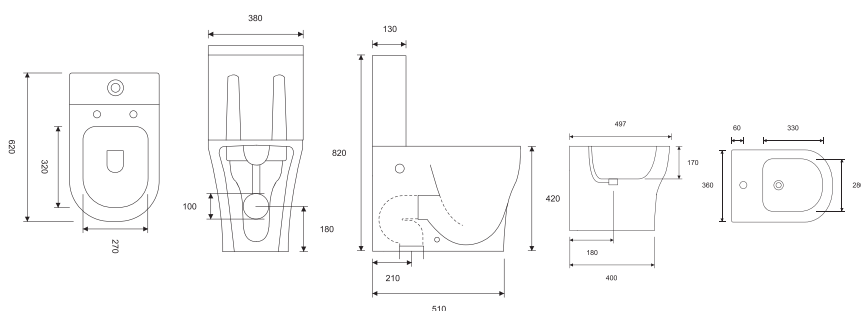

STYLE R SUSPENSO BRANCO

CF-SR02	STYLE R SUSPENSO / SANITA SUSPENSA + TAMPO SOFT CLOSE CLIP OFF	198 750,00	226 575,00
CF-SR07	STYLE R SUSPENSO / BIDÊ SUSPENSO	192 750,00	219 735,00

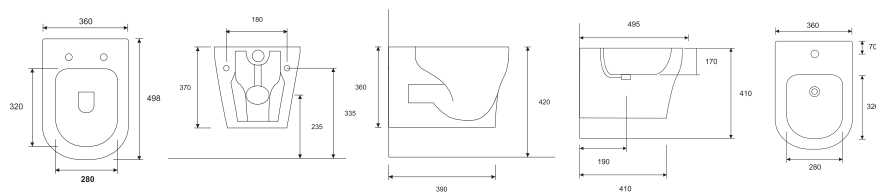



BOHEMIC BRANCO

RB-BH01

BOHEMIC PACK SANITA / SANITA + TANQUE
+ TAMPO SOFT CLOSE CLIP OFF

342 750,00

390 735,00

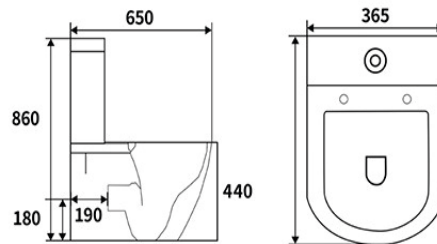

FLY BRANCO

RB-FY01

FLY PACK SANITA / SANITA + TANQUE +
TAMPO SOFT CLOSE CLIP OFF

328 750,00

374 775,00

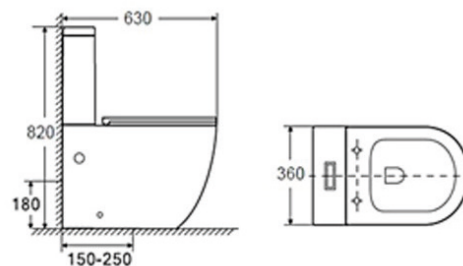



ROCK BRANCO

RB-RK01 ROCK PACK SANITA / SANITA + TANQUE + TAMPO SOFT CLOSE CLIP OFF 328 750,00 **374 775,00**

RB-RK05 ROCK BIDÉ COMPACTO 236 750,00 **269 895,00**

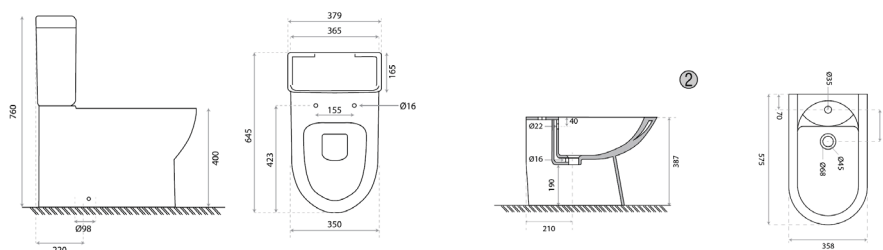

ULTRA BRANCO

RB-UT01 ULTRA PACK SANITA / SANITA + TANQUE + TAMPO SOFT CLOSE CLIP OFF 276 750,00 **315 495,00**

RB-UT05 ULTRA BIDÉ COMPACTO 220 750,00 **251 655,00**

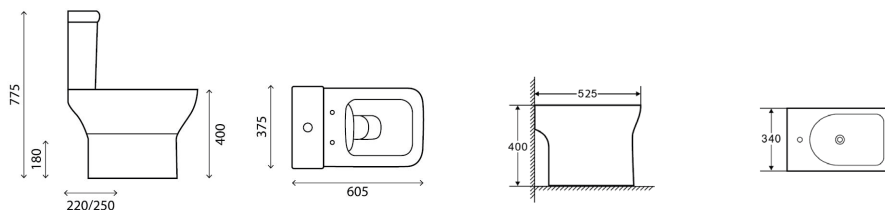



AQUARIO PLUS BRANCO

DAV-A010 AQUARIO PLUS PACK SANITA / SANITA + TANQUE + TAMPO SOFT CLOSE CLIP OFF 148 750,00 **169 575,00**

DAV-A014 AQUARIO PLUS BIDÉ COMPACTO 78 750,00 **89 775,00**

DAV-A015 AQUARIO PLUS LAVATÓRIO + COLUNA 55 CM 64 750,00 **73 815,00**

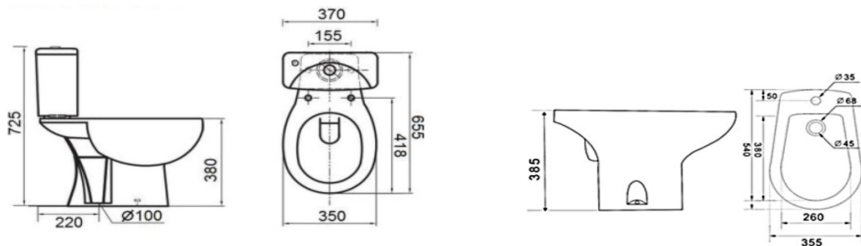

ORBITA BRANCO

BM-SN14 ORBITA PACK SANITA / SANITA + TANQUE + TAMPO SOFT CLOSE CLIP OFF 149 750,00 **170 715,00**

BM-SN15 ORBITA BIDÉ COMPACTO 124 750,00 **142 215,00**

BM-SN16 ORBITA LAVATÓRIO + COLUNA 55 CM 108 750,00 **123 975,00**

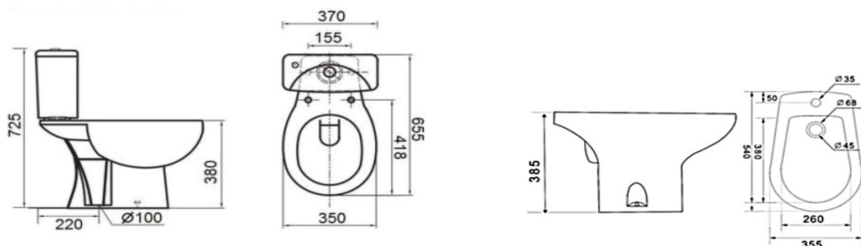



NEXO INFANTIL

ST-NX50	NEXO INFANTIL / SANITA+TAMPO AMARELO	256 750,00	292 695,00
ST-NX51	NEXO INFANTIL / SANITA+TAMPO AZUL	256 750,00	292 695,00
ST-NX52	NEXO INFANTIL / SANITA+TAMPO BRANCO	256 750,00	292 695,00
ST-NX53	NEXO INFANTIL / SANITA+TAMPO ROSA	256 750,00	292 695,00



URINOL WCA

SD-UR50	WCA - URINOL ENTRADA AGUA P/ TRÁS	228 950,00	261 003,00
----------------	-----------------------------------	------------	-------------------



URINOL CUBIC

SD-UR10	CUBIC - URINOL ENTRADA AGUA P/ CIMA	228 950,00	261 003,00
----------------	-------------------------------------	------------	-------------------



URINOL JADE

SD-UR20	JADE C/ TAMPA - URINOL ENTRADA AGUA P/ TRÁS	188 950,00	215 403,00
----------------	---	------------	-------------------

NOVIDADE



URINOL ORBITA

BM-SN17	ORBITA - URINOL ENTRADA AGUA P/ CIMA	77 500,00	88 350,00
----------------	--------------------------------------	-----------	------------------



AUTOCLISMO INTERIOR DAMA P/ SANITA SUSPENSA

SE-022

- Com estrutura para paredes de alvenaria, paredes ligeiras ou calha técnica
- Dupla descarga 3/6l; regulável 3/4,5l
- Isolamento anticondensação e acústico em EPS com alvéolos
- Torneira de boia silenciosa
- Profundidade 80 mm
- Suporta até 400 Kg
- Reservatório em polipropileno (PP) altamente resistente Temp. água máx. 25°C
- Marcação C E : EN 14055
- Eficiência energética: classe A
- Curva de esgoto ajustável em profundidade
- Altura regulável de 0-200 mm

284 750,00

324 615,00

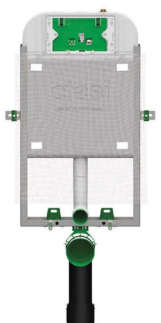

AUTOCLISMO INTERIOR EASY P/ SANITA SUSPENSA

SE-020

- Com estrutura para paredes de alvenaria
- Dupla descarga 3/6l; regulável 3/4,5l
- Isolamento anticondensação e acústico em EPS com alvéolos
- Torneira de boia silenciosa
- Profundidade 80 mm
- Reservatório em polipropileno (PP) altamente resistente Temp. água máx. 25°C
- Marcação CE: EN14055
- Eficiência energética: classe A
- Curva de esgoto ajustável em profundidade

219 750,00

250 515,00



AUTOCLISMO INTERIOR SIMPLES

SE-024

- Com estrutura para paredes de alvenaria
- Dupla descarga 3/6l; regulável 3/4,5l
- Isolamento anticondensação e acústico em EPS com alvéolos
- Torneira de boia silenciosa
- Profundidade 80 mm
- Reservatório em polipropileno (PP) altamente resistente Temp. água máx. 25°C
- Marcação CE: EN14055
- Eficiência energética: classe A
- Curva de esgoto ajustável em profundidade

195 750,00

223 155,00

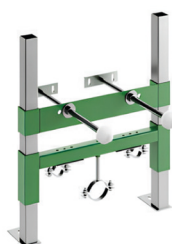

EXTRUTURA ENCASTRAR DAMA P/ BIDÉ SUSPENSO

SE-075

- Estrutura metálica para bidé
- Fixação à parede e ao chão
- Fácil instalação e manutenção
- Altura ajustável
- Suporta até 400 kg

117 750,00

134 235,00



AUTOCLISMO EXTERIOR IOCA / BASIC

SE-025

- Descarga interrompível (até 6 litros)
- Fácil regulação do volume de descarga máxima entre 6l e 9l
- Sistema de encaixe rápido do tubo de descarga
- Entrada de água lateral (esquerda/direita) e posterior
- Fácil instalação e manutenção
- Inclui todos os acessórios necessários para instalação
- Válvula de descarga com vedante em silicone
- Com tubo de descarga ø50 x ø40 x 325 mm

47 250,00

53 865,00

PLACAS P/ AUTOCLISMO DAMA ABS



SE-160	PLACA REDONDA DUPLA DESCARGA ABS BRANCO	37 750,00	43 035,00
SE-161	PLACA REDONDA DUPLA DESCARGA ABS CROMADO	37 750,00	43 035,00
SE-164	PLACA QUADRADA DUPLA DESCARGA ABS CROMADO	37 750,00	43 035,00

PLACAS P/ AUTOCLISMO DAMA INOX



SE-166	PLACA QUADRADA DUPLA DESCARGA INOX CROMADO	98 750,00	112 575,00
SE-167	PLACA QUADRADA DUPLA DESCARGA INOX PRETO	98 750,00	112 575,00
SE-168	PLACA QUADRADA DUPLA DESCARGA INOX DOURADO ESCOVADO	98 750,00	112 575,00

PLACAS P/ AUTOCLISMO EASY ABS



SE-163	PLACA REDONDA ROUND ABS PRETO	68 750,00	78 375,00
SE-163/B	PLACA REDONDA ROUND ABS BRONZE	168 950,00	192 603,00
SE-163/O	PLACA REDONDA ROUND ABS OURO	168 950,00	192 603,00
SE-165	PLACA QUADRADA KEEN ABS CROMADO	54 750,00	62 415,00

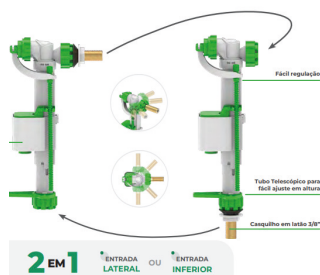

BOIA COMBI

SE-101	<ul style="list-style-type: none"> Fácil ajuste em altura Entrada lateral orientável a 180° Enchimento rápido e silencioso Excelente desempenho com qualquer pressão de rede Sistema de entrada de água ultra-silencioso Casquilho em latão Fácil adaptação para torneira de boia de entrada de água lateral ou inferior 	30 950,00	35 283,00
--------	---	-----------	-----------

BOIA SIMPLEX



SE-101-1	<ul style="list-style-type: none"> Torneira boia de entrada de água inferior para autoclismos cerâmicos Enchimento rápido e silencioso Casquilho em latão Fácil ajuste em altura 	19 950,00	22 743,00
----------	--	-----------	-----------

VALVULA DE DESCARGA DUO



SE-102	<ul style="list-style-type: none"> Válvula de dupla descarga para autoclismos cerâmicos Botão cromado Fácil e rápida instalação e ajuste em altura Descarga regulável Posicionamento do botão ajustável para todo o tipo de cisternas Inclui parafusos de fixação em aço inox para cisterna 	29 750,00	33 915,00
--------	---	-----------	-----------

SIFÃO URINOL GARRAFA



SE-225	SIFÃO GARRAFA LATÃO / ZAMAC CROMADO	27 750,00	31 635,00
--------	-------------------------------------	-----------	-----------

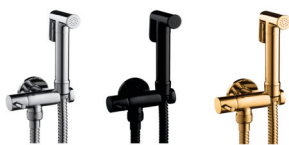

KIT CHUVEIROS HIGIENICOS

SD-253		KIT CHUVEIRO HIGIENICO 4 PÇAS	68 750,00	78 375,00
SD-253/P		KIT CHUVEIRO HIGIENICO 4 PÇAS	108 950,00	124 203,00
SD-253/O		KIT CHUVEIRO HIGIENICO 4 PÇAS	108 950,00	124 203,00



CHUVEIROS HIGIENICOS

SD-250		CHUVEIRO HIGIENICO ABS REDONDO	6 750,00	7 695,00
SD-250/P		CHUVEIRO HIGIENICO LATÃO REDONDO	25 750,00	29 355,00
SD-251		CHUVEIRO HIGIENICO LATÃO QUADRADO	25 750,00	29 355,00



SUPORTES C/ TOMADA

SD-513		SUPORTE CHUVEIRO REDONDO C/ TOMADA ÁGUA	24 750,00	28 215,00
SD-513/P		SUPORTE CHUVEIRO REDONDO C/ TOMADA ÁGUA	26 750,00	30 495,00
SD-511		SUPORTE CHUVEIRO QUADRADO C/ TOMADA ÁGUA	26 750,00	30 495,00



TORNEIRAS P/ CHUVEIROS HIGIENICOS

SD-604		TORNEIRA ESQUADRIA C/ SUPORTE CHUVEIRO	29 750,00	33 915,00
SD-603		TORNEIRA ESQUADRIA SAIDA DUPLA	26 750,00	30 495,00



BICHAS DE CHUVEIRO

SD-110		BICHA CHUVEIRO ARGOLAS 90-120 cm	5 750,00	6 555,00
SD-111		BICHA CHUVEIRO ARGOLAS 150-180 cm	6 750,00	7 695,00
SD-112/P		BICHA CHUVEIRO DUO 170 cm	18 750,00	21 375,00



TORNEIRAS ESQUADRIA

SD-605		TORNEIRA ESQUADRIA QUADRADA 1/2-3/8	12 750,00	14 535,00
SD-606		TORNEIRA ESQUADRIA QUADRADA 1/2-1/2	12 750,00	14 535,00



SD-608		TORNEIRA ESQUADRIA REDONDA 1/2-1/2	10 750,00	12 255,00
SD-607		TORNEIRA ESQUADRIA REDONDA 1/2-3/8	10 750,00	12 255,00
SD-607/P		TORNEIRA ESQUADRIA REDONDA 1/2-3/8	14 750,00	16 815,00
SD-607/O		TORNEIRA ESQUADRIA REDONDA 1/2-3/8	14 750,00	16 815,00



SD-600		TORNEIRA ESQUADRIA 1/2-3/8	5 950,00	6 783,00
SD-601		TORNEIRA ESQUADRIA 1/2-1/2	5 950,00	6 783,00
SD-602		TORNEIRA ESQUADRIA 1/2-3/4	5 950,00	6 783,00

BICHAS MALHA DE AÇO

SD-100	BICHA MALHA DE AÇO 3/8-3/8 F-F	3 750,00	4 275,00
SD-101	BICHA MALHA DE AÇO 1/2-3/8 F-F	3 750,00	4 275,00
SD-102	BICHA MALHA DE AÇO 1/2-1/2 F-F	3 750,00	4 275,00
SD-103	BICHA MALHA DE AÇO 1/2-3/8 M-F	3 750,00	4 275,00
SD-104	BICHA MALHA DE AÇO 1/2-1/2 M-F	3 750,00	4 275,00

**SIFÃO SANITA UNIVERSAL FLEXÍVEL**

SE-252	SIFÃO SANITA UNIVERSAL FLEXIVEL	16 950,00	19 323,00
SE-253	SIFÃO SANITA UNIVERSAL FLEXIVEL CURVO	16 950,00	19 323,00



SE-250	SIFÃO SANITA AO CHÃO / PVC	28 250,00	32 205,00
---------------	----------------------------	-----------	------------------



SE-251	SIFÃO SANITA A PAREDE / PVC	29 750,00	33 915,00
---------------	-----------------------------	-----------	------------------

**EXCENTRICO SANITA**

SE-080	EXCENTRICO SANITA PVC	3 500,00	3 990,00
---------------	-----------------------	----------	-----------------

**EMBOQUE SANITA**

SE-096	EMBOQUE SANITA INTERIOR / PVC	2 750,00	3 135,00
---------------	-------------------------------	----------	-----------------

**JUNTA VEDAÇÃO**

SE-095	JUNTA TANQUE SANITA	11 950,00	13 623,00
---------------	---------------------	-----------	------------------

**PARAFUSOS**

SE-151	PARAFUSOS SANITA HORIZONTAL 2 UND / INOX	2 950,00	3 363,00
---------------	--	----------	-----------------

SE-152	PARAFUSOS SANITA VERTICAL 2 UND / INOX	2 950,00	3 363,00
---------------	--	----------	-----------------



SE-153	PARAFUSOS SANITA - BIDÊ SUSPENSO / INOX	35 250,00	40 185,00
---------------	---	-----------	------------------



SE-154	PARAFUSOS TANQUE SANITA / INOX	13 750,00	15 675,00
---------------	--------------------------------	-----------	------------------



MATERIAIS DE CONSTRUÇÃO • CASAS DE BANHO • ELECTRODOMÉSTICOS • DECORAÇÃO

LOJA E SHOWROOM

Rua do Imetro S/Nº
Morro Bento - Samba - Luanda
T. +244 940 617 270
E. loja@dama.ao

ARMAZÉM

Rua Direita da Toyota S/Nº
Morro Bento - Samba - Luanda
T. +244 926 646 036
E. geral@dama.ao

COMERCIAL

T. +244 949 546 578
E. comercial@dama.ao



Loja online: dama.ao

TEKA	ASSISTÊNCIA TÉCNICA	DOMEP T. +244 933 907 902 E. geral@domep.io
-------------	----------------------------	--