

A close-up, profile view of a woman's face, looking upwards and to the left. Her skin is a rich, warm brown. She has dramatic, dark eye makeup and long, dark eyelashes. Her lips are coated in a glossy, dark brown lipstick. Her face is adorned with shimmering gold makeup, including a large, ornate gold design on her right cheek and forehead. The background is a soft, golden-yellow gradient, and there are numerous small, glowing gold particles and larger, shimmering gold shapes scattered throughout the scene, creating a magical and ethereal atmosphere.

dama

SANITÁRIOS

ABRIL 2025



BOHEMIC PRETO MATE

RB-BH01-P BOHEMIC PACK SANITA / SANITA + TANQUE + TAMPO SOFT CLOSE CLIP OFF 732 250,00 **834 765,00**

RB-BH07-P BOHEMIC BIDÉ COMPACTO 456 250,00 **520 125,00**

RB-L022/P BOHEMIC LAVATÓRIO POU SAR 455x325mm 227 500,00 **259 350,00**

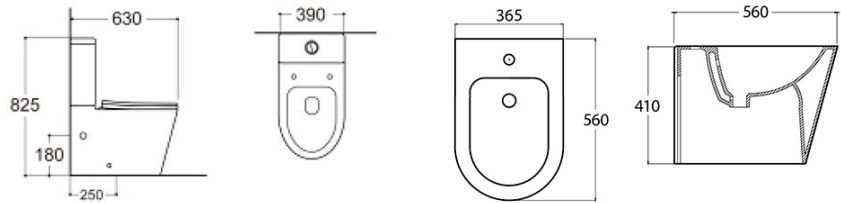

ELEGANT PRETO MATE

RB-EL02-1 ELEGANT SANITA SUSPensa + TAMPO SOFT CLOSE CLIP OFF 488 750,00 **557 175,00**

RB-EL08-1 ELEGANT BIDÉ SUSPENSO 424 750,00 **484 215,00**

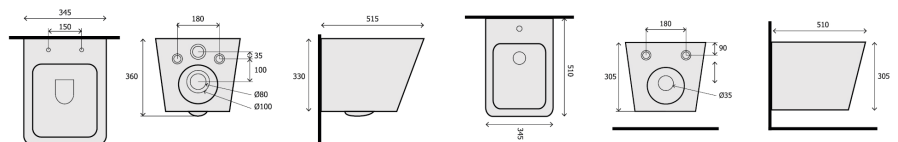



FLY CAPPUCINO MATE

RB-FY01-C	FLY PACK SANITA / SANITA + TANQUE + TAMPO SOFT CLOSE CLIP OFF	732 250,00	834 765,00
RB-FY07-C	FLY BIDÉ COMPACTO	456 250,00	520 125,00
RB-L022/CP	BOHEMIC LAVATÓRIO POUAR 455x325mm	243 750,00	277 875,00

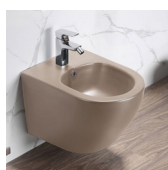
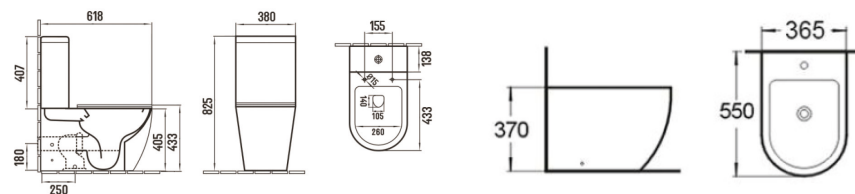

FLY SUSPENSO CAPPUCINO MATE

RB-FY02-C	FLY SANITA SUSPENSA + TAMPO SOFT CLOSE CLIP OFF	488 750,00	557 175,00
RB-FY08-C	FLY BIDÉ SUSPENSO	424 750,00	484 215,00

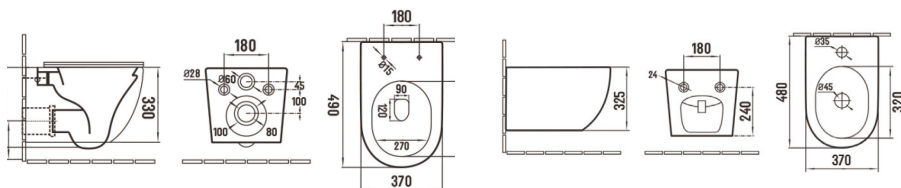



GLAMIC CINZA MATE

RB-GL01-C	GLAMIC PACK SANITA / SANITA + TANQUE + TAMPO SOFT CLOSE CLIP OFF	732 250,00	834 765,00
RB-GL07-C	GLAMIC BIDÉ COMPACTO	456 250,00	520 125,00
RB-L022/C	BOHEMIC LAVATÓRIO POUSAR 455x325mm	196 250,00	223 725,00

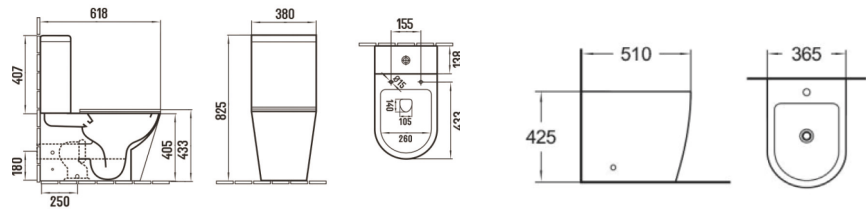

GLAMIC SUSPENSO CINZA

RB-GL02-C	GLAMIC SANITA SUSPENSA + TAMPO SOFT CLOSE CLIP OFF	488 750,00	557 175,00
RB-GL08-C	GLAMIC BIDÉ SUSPENSO	424 750,00	484 215,00

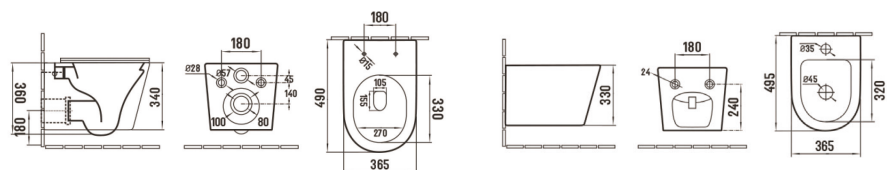



ELEGANT CINZA ESCURO MATE

RB-EL01-C ELEGANT PACK SANITA / SANITA + TANQUE + TAMPO SOFT CLOSE CLIP OFF 732 250,00 **834 765,00**

RB-EL07-C ELEGANT BIDÉ COMPACTO 456 250,00 **520 125,00**

RB-L022/CE BOHEMIC LAVATÓRIO POUSAR 455x325mm 196 250,00 **223 725,00**

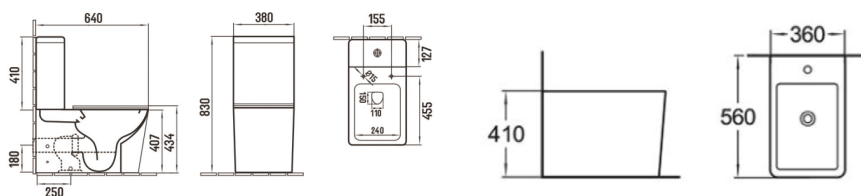

BOHEMIC BRANCO MATE

RB-BH01-B BOHEMIC PACK SANITA / SANITA + TANQUE + TAMPO SOFT CLOSE CLIP OFF 658 750,00 **750 975,00**

RB-BH07-M BOHEMIC BIDÉ COMPACTO 412 750,00 **470 535,00**

RB-L022/B BOHEMIC LAVATÓRIO POUSAR 455x325mm 196 250,00 **223 725,00**

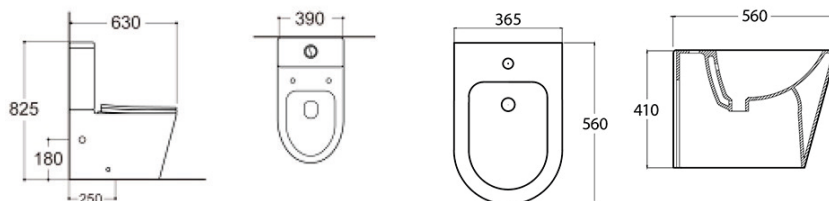



R2 BRANCO

CF-R201 R2 PACK SANITA / SANITA + TANQUE + TAMPO SOFT CLOSE CLIP OFF 422 750,00 **481 935,00**

CF-R207 R2 BIDÊ COMPACTO 248 750,00 **283 575,00**

CF-L016 A2S LAVATÓRIO POU SAR 455x395mm 104 750,00 **119 415,00**

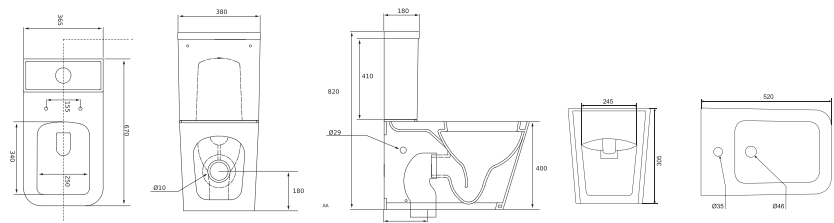

R2 SUSPENSO BRANCO

CF-R202 R2 SANITA SUSPENSA + TAMPO SOFT CLOSE CLOSE CLIP OFF 322 750,00 **367 935,00**

CF-R208 R2 BIDÊ SUSPENSO 278 750,00 **317 775,00**

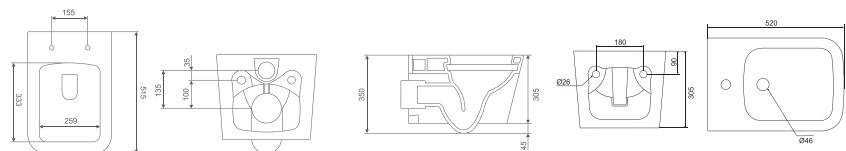



A2 BRANCO

CF-A201 A2 PACK SANITA / SANITA + TANQUE + TAMPO SOFT CLOSE CLIP OFF 398 750,00 **454 575,00**

CF-A207 A2 BIDÉ COMPACTO 218 750,00 **249 375,00**



CF-L017 A2R LAVATÓRIO POU SAR 415mm 84 750,00 **96 615,00**

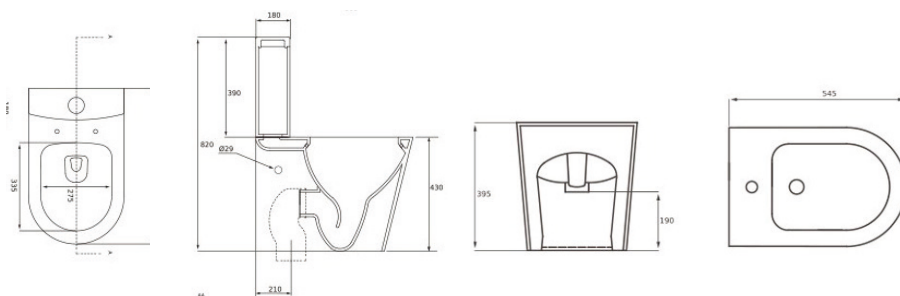

A2 SUSPENSO BRANCO

CF-A202 A2 SANITA SUSPENSA + TAMPO SOFT CLOSE CLIP OFF 262 750,00 **299 535,00**

CF-A208 A2 BIDÉ SUSPENSO 228 750,00 **260 775,00**

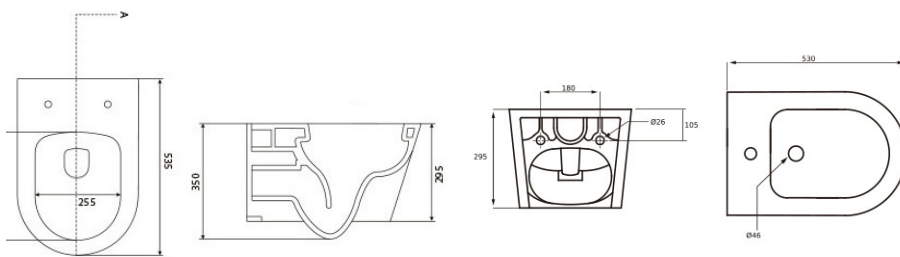



STYLE S BRANCO

CF-SS01 STYLE S PACK SANITA / SANITA + TANQUE + TAMPO SOFT CLOSE CLIP OFF 298 750,00 **340 575,00**

CF-SS08 STYLE S BIDÊ COMPACTO 148 750,00 **169 575,00**

CF-L015 A2 LAVATÓRIO POU SAR 450x330mm 86 750,00 **98 895,00**

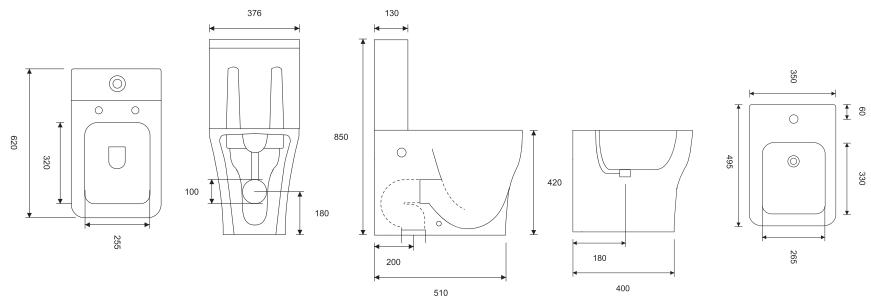

STYLE S SUSPENSO BRANCO

CF-SS02 STYLE S SUSPENSO / SANITA SUSPENSA + TAMPO SOFT CLOSE CLIP OFF 198 750,00 **226 575,00**

CF-SS07 STYLE S SUSPENSO / BIDÊ SUSPENSO 192 750,00 **219 735,00**

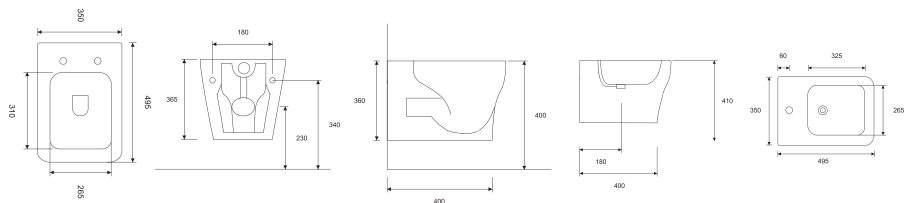



STYLE R BRANCO

CF-SR01	STYLE R PACK SANITA / SANITA + TANQUE + TAMPO SOFT CLOSE CLIP OFF	298 750,00	340 575,00
CF-SR08	STYLE R BIDÊ COMPACTO	156 750,00	178 695,00
CF-L017	A2R LAVATÓRIO POUVAR 415mm	84 750,00	96 615,00

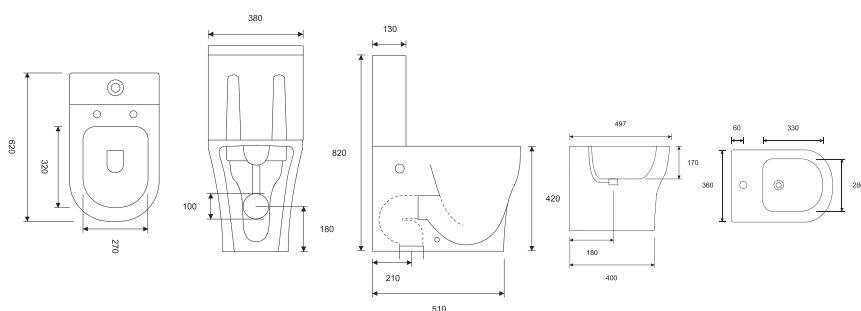

STYLE R SUSPENSO BRANCO

CF-SR02	STYLE R SUSPENSO / SANITA SUSPENSA + TAMPO SOFT CLOSE CLIP OFF	198 750,00	226 575,00
CF-SR07	STYLE R SUSPENSO / BIDÊ SUSPENSO	192 750,00	219 735,00

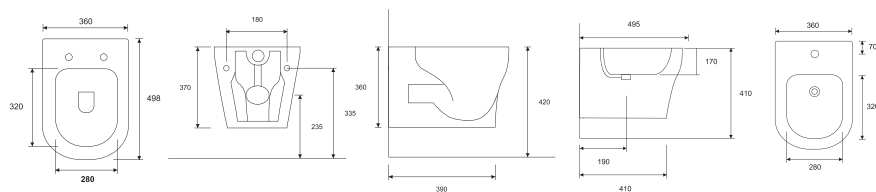



BOHEMIC BRANCO

RB-BH01

BOHEMIC PACK SANITA / SANITA + TANQUE
+ TAMPO SOFT CLOSE CLIP OFF

342 750,00

390 735,00

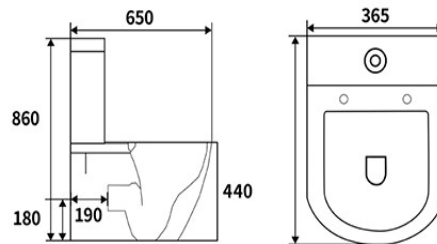

FLY BRANCO

RB-FY01

FLY PACK SANITA / SANITA + TANQUE +
TAMPO SOFT CLOSE CLIP OFF

328 750,00

374 775,00

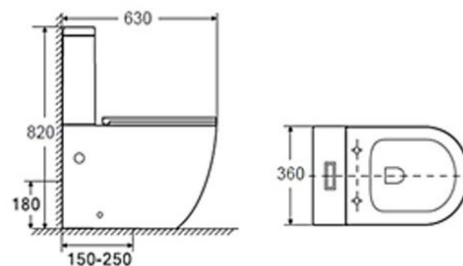



ROCK BRANCO

RB-RK01 ROCK PACK SANITA / SANITA + TANQUE + TAMPO SOFT CLOSE CLIP OFF 328 750,00 **374 775,00**

RB-RK05 ROCK BIDÉ COMPACTO 236 750,00 **269 895,00**

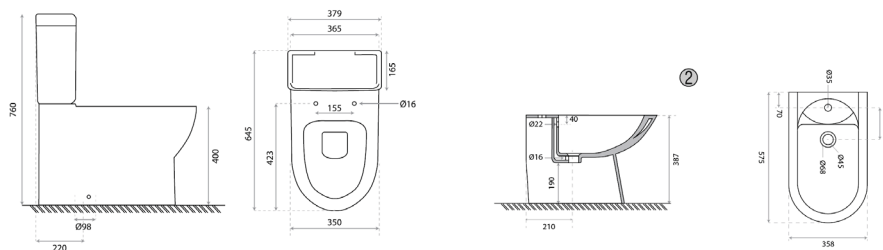

ULTRA BRANCO

RB-UT01 ULTRA PACK SANITA / SANITA + TANQUE + TAMPO SOFT CLOSE CLIP OFF 276 750,00 **315 495,00**

RB-UT05 ULTRA BIDÉ COMPACTO 220 750,00 **251 655,00**

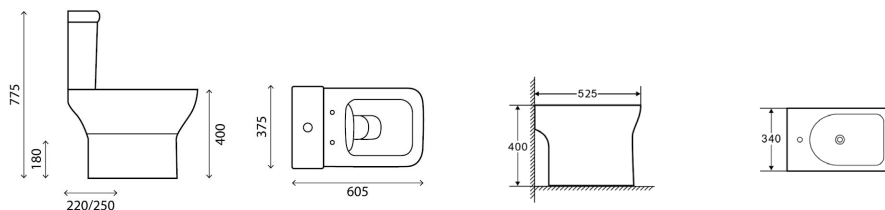



AQUARIO PLUS BRANCO

DAV-A010 AQUARIO PLUS PACK SANITA / SANITA + TANQUE + TAMPO SOFT CLOSE CLIP OFF 156 750,00 **178 695,00**

DAV-A014 AQUARIO PLUS BIDÉ COMPACTO 78 750,00 **89 775,00**

DAV-A015 AQUARIO PLUS LAVATÓRIO + COLUNA 55 CM 72 750,00 **82 935,00**

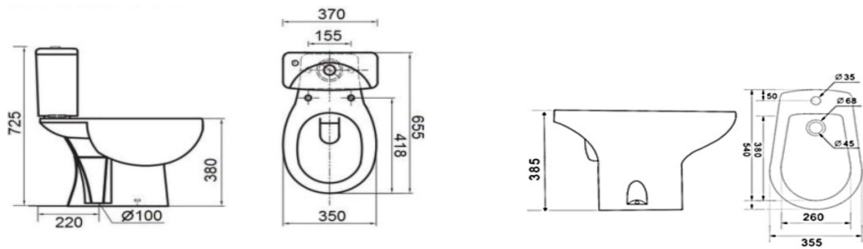

ORBITA BRANCO

BM-SN14 ORBITA PACK SANITA / SANITA + TANQUE + TAMPO SOFT CLOSE CLIP OFF 149 750,00 **170 715,00**

BM-SN15 ORBITA BIDÉ COMPACTO 124 750,00 **142 215,00**

BM-SN16 ORBITA LAVATÓRIO + COLUNA 55 CM 108 750,00 **123 975,00**

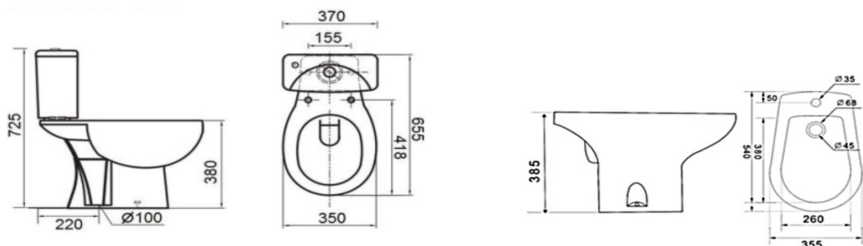



NEXO INFANTIL

ST-NX50	NEXO INFANTIL / SANITA+TAMPO AMARELO	256 750,00	292 695,00
ST-NX51	NEXO INFANTIL / SANITA+TAMPO AZUL	256 750,00	292 695,00
ST-NX52	NEXO INFANTIL / SANITA+TAMPO BRANCO	256 750,00	292 695,00
ST-NX53	NEXO INFANTIL / SANITA+TAMPO ROSA	256 750,00	292 695,00



URINOL WCA

SD-UR50	WCA - URINOL ENTRADA AGUA P/ TRÁS	228 950,00	261 003,00
----------------	-----------------------------------	------------	-------------------



URINOL CUBIC

SD-UR10	CUBIC - URINOL ENTRADA AGUA P/ CIMA	228 950,00	261 003,00
----------------	-------------------------------------	------------	-------------------



URINOL JADE

SD-UR20	JADE C/ TAMPA - URINOL ENTRADA AGUA P/ TRÁS	188 950,00	215 403,00
----------------	---	------------	-------------------

NOVIDADE



URINOL ORBITA

BM-SN17	ORBITA - URINOL ENTRADA AGUA P/ CIMA	77 500,00	88 350,00
----------------	--------------------------------------	-----------	------------------



AUTOCLISMO INTERIOR CIFIAL P/ SANITA SUSPENSA C/PLACA

SE-022-1

- Com estrutura para paredes de alvenaria, paredes ligeiras ou calha técnica
- Dupla descarga 3/6l; regulável 3/4,5l
- Isolamento anticondensação e acústico em EPS com alvéolos
- Torneira de boia silenciosa
- Profundidade 80 mm
- Suporta até 400 Kg
- Reservatório em polipropileno (PP) altamente resistente Temp. água máx. 25°C
- Marcação C E : EN 14055
- Eficiência energética: classe A
- Curva de esgoto ajustável em profundidade
- Altura regulável de 0-200 mm

284 750,00

324 615,00



AUTOCLISMO INTERIOR OLI SANITARBLOCK P/ SANITA SUSPENSA

OL-AU12

- Dupla Descarga de fábrica de 6/3 litros (ajustável para 4/2 ou 7/3 litros)
- 80mm de espessura
- Acionamento mecânico
- Pressão de rede entre 0.1 a 16 bar
- Resistente à humidade atmosférica (Hr <90%)
- Fabricado em material altamente resistente (Polipropileno) e inquebrável à temperatura ambiente.
- Torneira de Bóia silenciosa (Classe 2)
- Fornecido com isolamento anti-condensação e acústico

198 750,00

226 575,00



AUTOCLISMO INTERIOR OLI SIMPLEX P/ SANITA SUSPENSA

OL-AU10

- Dupla Descarga de fábrica de 6/3 litros (ajustável para 4/2 ou 7/3);
- Marcação CE: EN 14055;
- Acionamento mecânico;
- Tanque em polipropileno (PP), material extremamente resistente à temperatura ambiente;
- Fornecido com isolamento anti condensação e acústico;

128 750,00

146 775,00

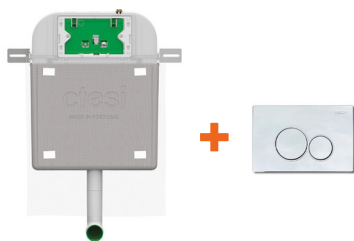

AUTOCLISMO INTERIOR SIMPLES

SE-024

- Com estrutura para paredes de alvenaria
- Dupla descarga 3/6l; regulável 3/4,5l
- Isolamento anticondensação e acústico em EPS com alvéolos
- Torneira de boia silenciosa
- Profundidade 80 mm
- Reservatório em polipropileno (PP) altamente resistente Temp. água máx. 25°C
- Marcação CE: EN14055
- Eficiência energética: classe A
- Curva de esgoto ajustável em profundidade

195 750,00

223 155,00



EXTRUTURA ENCASTRAR DAMA P/ BIDÉ SUSPENSO

SE-075

- Estrutura metálica para bidé
- Fixação à parede e ao chão
- Fácil instalação e manutenção
- Altura ajustável
- Suporta até 400 kg

117 750,00

134 235,00



AUTOCLISMO EXTERIOR IOCA / BASIC

SE-025

- Descarga interrompível (até 6 litros)
- Fácil regulação do volume de descarga máxima entre 6l e 9l
- Sistema de encaixe rápido do tubo de descarga
- Entrada de água lateral (esquerda/direita) e posterior
- Fácil instalação e manutenção
- Inclui todos os acessórios necessários para instalação
- Válvula de descarga com vedante em silicone
- Com tubo de descarga ø50 x ø40 x 325 mm"

47 250,00

53 865,00

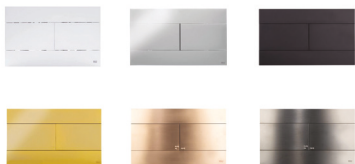
**PLACAS P/ AUTOCLISMO OLI SLIM**

OL-PC08	OLI PLACA SLIM BRANCO	87 750,00	100 035,00
OL-PC10	OLI PLACA SLIM CROMADO	100 750,00	114 855,00
OL-PC11	OLI PLACA SLIM COBRE	168 750,00	192 375,00
OL-PC12	OLI PLACA SLIM PRETO MATE	108 750,00	123 975,00
OL-PC13	OLI PLACA SLIM GUN METAL	168 750,00	192 375,00
OL-PC14	OLI PLACA SLIM OURO BRILHO	154 750,00	176 415,00

**TORNEIRA DE BOIA OLI IVC 100 PLUS 3/8****OL-MC10**

- Torneira de boia com sistemas de abertura retardada;
- Ideal para autoclismos compactos, devido às suas dimensões reduzidas;
- Entrada de água lateral e/ou inferior numa só torneira de boia, com racord de 3/8" em latão;
- Ajustável em altura na aplicação inferior;
- Sistema de fecho de contra pressão (hidráulico): Pressão Dinâmica de funcionamento: 0,1-8 bar; Pressão Estática: 8 bar (máx.);
- Fácil manutenção, com filtro integrado que pode ser limpo sem necessidade de desligar da rede;
- Sistema anti-retorno.

24 750,00

28 215,00**TORNEIRA DE BOIA OLI UNIBOTTOM 3/8****OL-MC12**

- Torneira de Boia de aplicação inferior, com ligação em latão de 3/8" ou 1/2";
- Sistema de fecho de pistão, pressão de rede: Pressão Dinâmica de funcionamento: 0,5-8 bar; Pressão Estática: 10 bar (máx.).

14 750,00

16 815,00**VALVULA DE DESCARGA OLI DECO CABOS****OL-MC20**

- Válvula de descarga simples;
- Aplicação do botão de acionamento frontal, universal;
- Acionamento mecânico < 20 N;
- Tubo ladrão telescópico;

31 750,00

36 195,00**KIT DE DESCARGA OLI + BOIA****OL-MC30**

- Entrada de água superior e inferior;

40 750,00

46 455,00**SIFÃO URINOL GARRAFA****SE-225**

SIFÃO GARRAFA LATÃO / ZAMAC CROMADO

27 750,00

31 635,00

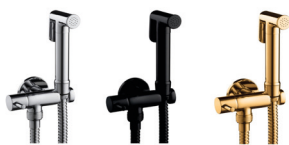

KIT CHUVEIROS HIGIENICOS

SD-253	KIT CHUVEIRO HIGIENICO 4 PÇAS	68 750,00	78 375,00
SD-253/P	KIT CHUVEIRO HIGIENICO 4 PÇAS	108 950,00	124 203,00
SD-253/O	KIT CHUVEIRO HIGIENICO 4 PÇAS	108 950,00	124 203,00



CHUVEIROS HIGIENICOS

SD-250	CHUVEIRO HIGIENICO ABS REDONDO	6 750,00	7 695,00
SD-250/P	CHUVEIRO HIGIENICO LATÃO REDONDO	25 750,00	29 355,00
SD-251	CHUVEIRO HIGIENICO LATÃO QUADRADO	25 750,00	29 355,00



SUPORTES C/ TOMADA

SD-513	SUPORTE CHUVEIRO REDONDO C/ TOMADA ÁGUA	24 750,00	28 215,00
SD-513/P	SUPORTE CHUVEIRO REDONDO C/ TOMADA ÁGUA	26 750,00	30 495,00
SD-511	SUPORTE CHUVEIRO QUADRADO C/ TOMADA ÁGUA	26 750,00	30 495,00



TORNEIRAS P/ CHUVEIROS HIGIENICOS

SD-604	TORNEIRA ESQUADRIA C/ SUPORTE CHUVEIRO	29 750,00	33 915,00
SD-603	TORNEIRA ESQUADRIA SAIDA DUPLA	26 750,00	30 495,00



BICHAS DE CHUVEIRO

SD-110	BICHA CHUVEIRO ARGOLAS 90-120 cm	5 750,00	6 555,00
SD-111	BICHA CHUVEIRO ARGOLAS 150-180 cm	6 750,00	7 695,00
SD-112/P	BICHA CHUVEIRO DUO 170 cm	18 750,00	21 375,00



TORNEIRAS ESQUADRIA

SD-605	TORNEIRA ESQUADRIA QUADRADA 1/2-3/8	12 750,00	14 535,00
SD-606	TORNEIRA ESQUADRIA QUADRADA 1/2-1/2	12 750,00	14 535,00



SD-608	TORNEIRA ESQUADRIA REDONDA 1/2-1/2	10 750,00	12 255,00
SD-607	TORNEIRA ESQUADRIA REDONDA 1/2-3/8	10 750,00	12 255,00
SD-607/P	TORNEIRA ESQUADRIA REDONDA 1/2-3/8	14 750,00	16 815,00
SD-607/O	TORNEIRA ESQUADRIA REDONDA 1/2-3/8	14 750,00	16 815,00



SD-600	TORNEIRA ESQUADRIA 1/2-3/8	5 950,00	6 783,00
SD-601	TORNEIRA ESQUADRIA 1/2-1/2	5 950,00	6 783,00
SD-602	TORNEIRA ESQUADRIA 1/2-3/4	5 950,00	6 783,00

BICHAS MALHA DE AÇO

SD-100	BICHA MALHA DE AÇO 3/8-3/8 F-F	3 750,00	4 275,00
SD-101	BICHA MALHA DE AÇO 1/2-3/8 F-F	3 750,00	4 275,00
SD-102	BICHA MALHA DE AÇO 1/2-1/2 F-F	3 750,00	4 275,00
SD-103	BICHA MALHA DE AÇO 1/2-3/8 M-F	3 750,00	4 275,00
SD-104	BICHA MALHA DE AÇO 1/2-1/2 M-F	3 750,00	4 275,00

**SIFÃO SANITA UNIVERSAL FLEXÍVEL**

SE-252	SIFÃO SANITA UNIVERSAL FLEXIVEL	16 950,00	19 323,00
SE-253	SIFÃO SANITA UNIVERSAL FLEXIVEL CURVO	16 950,00	19 323,00



SE-250	SIFÃO SANITA AO CHÃO / PVC	28 250,00	32 205,00
---------------	----------------------------	-----------	------------------



SE-251	SIFÃO SANITA A PAREDE / PVC	29 750,00	33 915,00
---------------	-----------------------------	-----------	------------------

**EXCENTRICO SANITA**

SE-080	EXCENTRICO SANITA PVC	3 500,00	3 990,00
---------------	-----------------------	----------	-----------------

**EMBOQUE SANITA**

SE-096	EMBOQUE SANITA INTERIOR / PVC	2 750,00	3 135,00
---------------	-------------------------------	----------	-----------------

**JUNTA VEDAÇÃO**

SE-095	JUNTA TANQUE SANITA	11 950,00	13 623,00
---------------	---------------------	-----------	------------------

**PARAFUSOS**

SE-151	PARAFUSOS SANITA HORIZONTAL 2 UND / INOX	2 950,00	3 363,00
---------------	--	----------	-----------------

SE-152	PARAFUSOS SANITA VERTICAL 2 UND / INOX	2 950,00	3 363,00
---------------	--	----------	-----------------



SE-153	PARAFUSOS SANITA - BIDÉ SUSPENSO / INOX	35 250,00	40 185,00
---------------	---	-----------	------------------



SE-154	PARAFUSOS TANQUE SANITA / INOX	13 750,00	15 675,00
---------------	--------------------------------	-----------	------------------



MATERIAIS DE CONSTRUÇÃO • CASAS DE BANHO • ELECTRODOMÉSTICOS • DECORAÇÃO

LOJA E SHOWROOM

Rua do Imetro S/Nº
Morro Bento - Samba - Luanda
T. +244 940 617 270
E. loja@dama.ao

ARMAZÉM

Rua Direita da Toyota S/Nº
Morro Bento - Samba - Luanda
T. +244 926 646 036
E. geral@dama.ao

COMERCIAL

T. +244 949 546 578
E. comercial@dama.ao



Loja online: dama.ao

TEKA

ASSISTÊNCIA TÉCNICA

DOMEP

T. +244 933 907 902
E. geral@domep.io